



Cisco Unified CallConnector Mobility Service

Technical Overview

This document provides detailed information on the features, operation, configuration and troubleshooting for the Cisco Unified CallConnector Mobility Service

Cisco Systems, Inc.
12/20/2007

TABLE OF CONTENTS

OVERVIEW	5
UNIFIED CALLCONNECTOR MOBILITY SERVICE	6
SINGLE NUMBER REACH	7
<i>Call Flow for the Single Number Reach Service</i>	8
PERSONAL ROUTING POLICIES.....	9
SINGLE VOICE MAILBOX	9
MID-CALL FEATURES	10
DIAL-IN ACCESS	10
<i>Call Flow for the Dial-In Access Service</i>	11
SWITCHING THE CALL TO THE IP PHONE	13
SIMULTANEOUS RINGING	13
MOBILITY SERVICE FEATURE SUMMARY	14
MOBILITY SERVICE SYSTEM FEATURES.....	14
MOBILITY SERVICE USER FEATURES	17
SETTING UP PERSONAL MOBILITY SERVICE	20
SETTING UP A SINGLE NUMBER REACH RULE:	21
<i>Setup Single Number Reach Conditions:</i>	23
<i>Setup Single Number Reach Actions:</i>	26
<i>Setup Status Update Actions:</i>	27
EXAMPLES OF SINGLE NUMBER REACH RULES	29
<i>Send my Business Calls to my Mobile phone</i>	29
<i>Working from Home Rule</i>	30
<i>Call Routing Outside Work Hours</i>	33
<i>Call Routing When Traveling on Business</i>	34
<i>Priority Interruptions When on Holiday</i>	37
INSTALLATION	40
INSTALLATION FILES	40
MOBILITY CONFIGURATION OVERVIEW	41
CME/CUE SETUP REQUIREMENTS:.....	41
CME/CUE SETUP SUMMARY FOR MOBILITY SERVICE.....	42
CONFIGURATION FOR SNR SERVICE - SUMMARY	44
CONFIGURATION FOR DISA SERVICE - SUMMARY	45
MULTIPLE ROUTERS FOR UCC SERVER.....	46
CONFIGURING MOBILITY EPHONES/EPHONE POOLS	48
<i>Mobility Ephone Attributes</i>	48
<i>Ephone Pools</i>	49

<i>Number of Ephones for Mobility Services</i>	49
CME CONFIGURATION FOR MOBILITY SERVICES	50
SETTING UP A MOBILITY-EPHONE.....	50
<i>Setup an ePhone with Share-Call Appearance:</i>	50
SETTING UP THE RADIUS ACCOUNTING.....	52
<i>Radius Parameters</i>	52
<i>Radius Configuration Notes</i>	52
<i>To Setup Radius Parameters on CME Router</i>	53
<i>Verifying Radius Settings</i>	54
SETUP ON CONFERENCING:.....	56
<i>Enabling DSP Farm Services for a Voice Card</i>	56
<i>Configuring Join and Leave Tones</i>	56
<i>Configuring SCCP for Cisco Unified CME</i>	57
<i>Configuring the DSP Farm</i>	57
<i>Associating Cisco Unified CME with a DSP Farm Profile</i>	57
<i>Enabling Multi-Party Ad Hoc and Meet-Me Conferencing</i>	58
<i>Configuring Multi-Party Ad Hoc Conferencing and Meet-Me Numbers</i>	58
<i>Configuring Conferencing Options for a Phone</i>	59
SETUP DIRECT TRANSFER TO VOICEMAIL.....	60
<i>Introduction</i>	60
<i>To Setup the Transfer-to-Voicemail Script</i>	61
SETUP HUNT GROUP FOR DISA CALLS:.....	66
<i>Hunt Group Configuration</i>	66
<i>Verifying Hunt Groups</i>	67
CONFIGURING UCC MOBILITY SERVICE	69
REGISTERING UCC MOBILITY SERVICE	70
<i>To Register UCC Mobility Software</i>	70
VERIFY PRESENCE RADIUS SERVER SETTINGS.....	71
<i>To Setup and Verify Radius Settings</i>	71
ROUTER LOCATION AND FEATURE SETTINGS.....	74
<i>To Setup the Router Location Parameters:</i>	74
<i>Telnet Access:</i>	75
<i>Voice Mail:</i>	76
<i>Ephones:</i>	76
<i>CME/UC500 Location:</i>	77
<i>To Add or Update Router Location Information</i>	78
ADVANCED DIALING TRANSLATIONS FOR SERVER.....	79
<i>Notes on Dialing Translations</i>	79
<i>Dial Translation Parameters:</i>	80
<i>To Setup the Dialing Rule:</i>	82
<i>To Setup a Lookup Rule:</i>	82
CONFIGURE MOBILITY-EPHONES	83
<i>Notes on Mobility Ephones</i>	83
<i>Mobility Ephone Setup Overview</i>	84
<i>Provisioning Mobility Ephones</i>	84
<i>Download CME configuration</i>	85

<i>Select Mobility Ephones</i>	86
<i>Verify Mobility Ephones</i>	88
<i>Creating Ephone Pools</i>	89
<i>Assign ephones to ephone Pools:</i>	93
<i>Add ePhones with Shared DN to Dedicated Ephone Pool:</i>	93
SETUP SNR AND DISA SYSTEM PARAMETERS	94
<i>Single Number Reach Options:</i>	95
<i>Dial-in Access Options:</i>	96
<i>Transmit Caller Phone Number:</i>	96
HOLIDAY AND WORK DAY/TIME SCHEDULES	97
<i>To Setup Holiday Schedule</i>	97
<i>To Setup Working Hours</i>	97
<i>To Setup Working Days</i>	98
UPDATE USER CONTACT DETAILS.....	98
TROUBLESHOOTING	99
MOBILITY FEATURES TROUBLESHOOTING.....	99
<i>Single Number Reach doesn't work:</i>	99
<i>The Mid-Call Features doesn't work:</i>	99
<i>The reached call gets dropped when the user answers it:</i>	100
<i>The Dial-in System Access doesn't work:</i>	100
<i>The Mobility Service doesn't play custom recorded voice prompt:</i>	101
RULES DIAGNOSTICS TOOL	102
APPENDIX A.....	105
<i>Replace Voice Prompt with Custom Recorded Files:</i>	105
APPENDIX B.....	107
CME CONFERENCING.....	107
APPENDIX C.....	119
TRANSFER TO VOICE MAIL SETUP.....	119

OVERVIEW

This document provides an overview of the Cisco Unified CallConnector Mobility solution. It describes the key features and different modes of operations.

The Cisco Unified CallConnector Mobility Service provides the following general capabilities:

- Intelligent personalized routing of incoming calls to the user – this is often referred to as Single Number Reach.
- Allowing users to setup their own personalized call routing policies that can take account of the user's current availability and location settings.
- Return the call to the Cisco Unity Voicemail box allowing the convenience of a single voice mailbox.
- Providing access to the business CME features while on a Mobility Service call – known as Mid-Call feature access.
- Allowing users to place calls through the Cisco CME and to access the telephone system features. This is known as Dial-In System Access.

This document describes begins with descriptions of each key feature of the Cisco Unified CallConnector Mobility solution. Then it goes through step-by-step tutorials on to setup a personalized Single Number Reach rule using the CallConnector Rules Wizard interface.

In the installation and configuration chapters, detailed information is provided on the CME provisioning and UCC Mobility Service configuration. The last chapter describes the trouble shooting steps for some of the common setup problems.

The primary audience for this technical overview are Cisco system engineers, and the channel support engineers. The objective is to provide information on the features and operations of UCC Mobility solution and detailed steps for setting up the service.

UNIFIED CALLCONNECTOR MOBILITY SERVICE

The Cisco Unified CallConnector Mobility Service is an optional and separately licensed part of the Cisco Unified CallConnector Server. It is a server application that integrates with Cisco Unified Communications Manager Express (Cisco CME) to connect the workers who are away from their desk to their business calls.

This chapter provides an overview of the Cisco Unified CallConnector Mobility Service and describes the following mobility features in more detail:

Key Features	Description
Single Number Reach (SNR)	Allows users to be connected to their business calls at the most convenient and available telephone when they are not at their desk. With the Single Number Reach service, user's can provide their business telephone number as their single contact number and control which calls reach them at their personal numbers.
Personalized Routing Policies	Personalized Routing Policies allow users to customize the Single Number Reach service by specifying the conditions under which the incoming business calls are routed. Users can have different routing rules based on their current availability, location, the caller or the date/time of the call. This provides an intelligent, rules-based, automated service for users to handle their business calls when they are not in the office.
Single Voice Mailbox	When the mobility service tries to reach a user and the user is not available to accept the call at any of their numbers, then the mobility service returns the call to the user's voicemail box providing a single repository for the business voice messages.
Mid-Call Features	Allows users to access Cisco CallConnector Mobility features such as updating presence status and/or location, transferring the call to voicemail, or adding additional parties to the call. The mid-call features are available (as a system option) for calls that have been placed by the Single Number Reach service.
Dial-in System Access (DISA)	Allows users to use their business telephone service to make calls when they are away from their office. While on these calls they have access to the Cisco CME features such as conferencing and call transfer.

Switching the SNR call to their IP-Phone	This facility allows user' to move a SNR call from their current telephone to another instrument while maintaining the call. With a "Shared-Appearance" configuration, the users can pick up the SNR call by pressing a line button on their IP Phone.
Simultaneous Call Ringing	Users can to setup their routing policies to simultaneously ring their work, home, or mobile phones. The incoming business call can be picked up at any one of these numbers.

Single Number Reach

Cisco Unified CallConnector (Cisco UCC or UCC) Single Number Reach service delivers business calls to workers on a phone of their choice at their current location. Cisco Unified CallConnector Mobility Service integrates with Cisco CME to monitor incoming business calls and then route or bridge them based on user-specified call-handling rules. Whether at home or from remote locations, workers can place or receive calls through the Cisco CME and take advantage of their business's unified communications infrastructure.

The Single Number Reach (SNR) feature routes incoming business calls to the user's multiple reach numbers by ringing all the numbers simultaneously. If the user answers at one of these numbers then they are connected to the caller, otherwise the incoming call is sent to the user's Cisco Unity Express (Cisco CUE) voice mailbox. The Cisco UCC Single Number Reach feature is customizable by each user. Users can setup their policies or rules for when, which call, from which number or caller and based on the user's current availability where they are to be reached. The Single Number Reach can be viewed as an intelligent user-policy based routing of business calls.

For example, a user can set up a rule to have their calls routed to their mobile phone when their availability status is set to 'Away' and location is set to 'On the Road'. Before leaving for the trip, the user can change their status to 'Away' and 'On the Road'. The Single Number Reach service will route any incoming calls to the user's mobile phone. Routing rules can also be simple and unconditional – send all calls to the home number.

Users need only to give their business contacts a single number to reach them no matter where they are. They can then control which calls and the time periods in which to receive business calls. The user's personal numbers are not visible to the business callers.

The Single Number Reach service can ring one or more of following phone numbers simultaneously:

- Work phone
- Home phone
- Mobile phone
- Any other alternate phone number

Users can also have different call routing rules for:

- Holidays
- Workdays or weekends
- Working hours

Single Number Reach with CME & Unified Mobility Connector

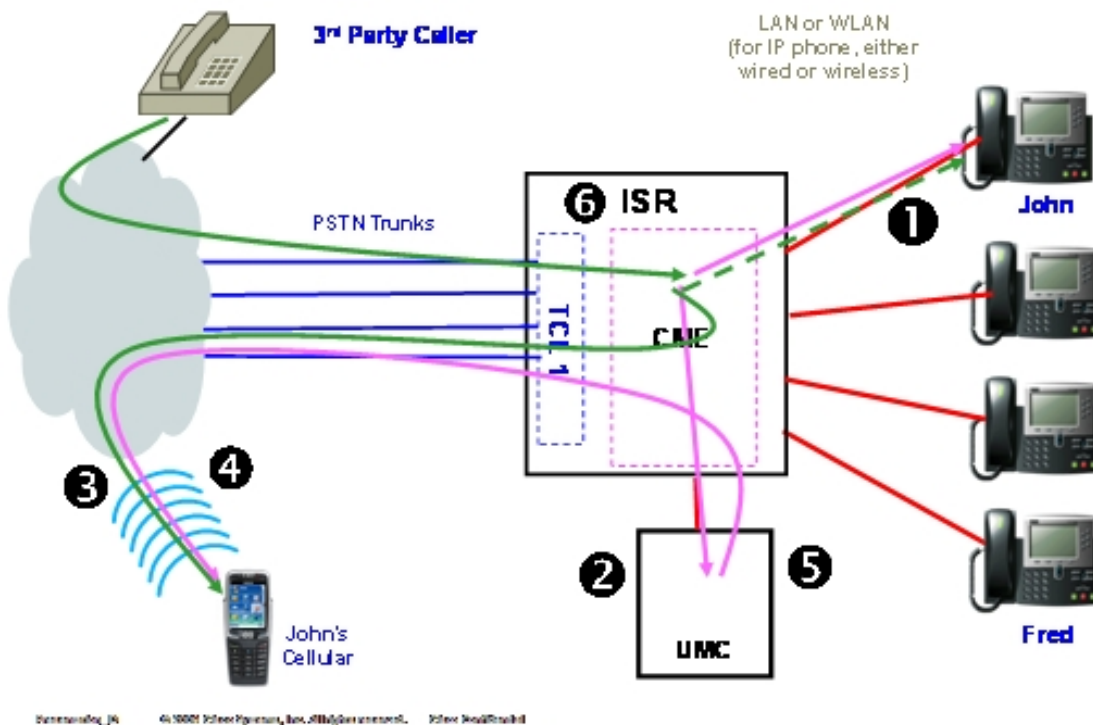

Call Flow for the Single Number Reach Service

1. Incoming call rings the user's business IP Phone. The IP Phone rings briefly e.g. John's business IP phone.
2. The UCC Mobility Service monitors the number on the user's behalf and answers the call. The caller is asked hold, while other numbers are tried.
3. Based on the user's rule settings, one or more calls are made to the user's reach numbers e.g. John's mobile phone.
4. If John answers the call, the Mobility Service prompts for a password.
5. If a valid password is entered, then the caller and the user are connected.
6. If the user cannot be reached, then the caller is sent to the user's voice mailbox e.g. John's voice mailbox.

Personal Routing Policies

The Personal Routing Policies provides a convenient way for users to set up some automated tasks such as routing incoming calls or updating presence status/location/message based on various conditions. The Single Number Reach service relies on the user's personal policy settings to handle their incoming business calls.

A Personal Policy or Rule setting consists of two separate sections – a set of conditions and a set of actions to be executed when the conditions are met. Conditions are specified values for a selected set of parameters that are constantly monitored by the Unified CallConnector. Actions are the tasks that are performed automatically on behalf of the user when all the condition parameters associated with a rule are true.

Parameters that are monitored by the Unified CallConnector that can be selected as condition parameters in a rule include:

- Incoming calls to the user's IP Phone. (This condition must be selected for SNR rules).
- The telephone number of the caller.
- Whether the caller's number is in the user's personal contacts, speed dial list, corporate directory, or a list of user-specified telephone numbers.
- The user's current availability -- Available, Away, Busy, or Unavailable.
- The user's current location -- Home, Work, On the Road, or On Vacation
- If the day is weekend, holiday, a workday or a particular day of the week
- If the current time is in working hours or after work hours

Tasks that can be performed automatically on behalf of the user

- Route incoming calls to the user's work, home, or mobile phone.
- Update the user's availability status to Available, Away, Busy or Unavailable
- Update the user's location to Home, Work, On the road, or On vacation
- Update the user's status message to Busy, Be right back, Stepped out, Away from keyboard, On the phone, or a Custom message

Each user can setup one or more policies or rules to tell the Unified CallConnector system to perform the specified tasks automatically on their behalf.

Single Voice Mailbox

The Single Voice Mailbox provides centralized voice mailbox solution for the users business calls. If users were give out multiple contact numbers such as work and mobile phones, then they need to check at multiple voice mailboxes for messages. With the Single Number Reach service, all the business calls that are missed are routed to the user's Cisco Unity voice mailbox. All the messages are in one place. They can be archived, forwarded and reviewed as needed from one system.

Mid-Call Features

The Unified CallConnector Mid-Call feature is an option that allows users to access Cisco CME features such as transferring to their voice mailbox, extending the call to a multi-party conference and more during an SNR call.

If the Mid-Call features are enabled for the Single Number Reach service, then the Mobility Server stays connected in the call between the caller and user to allow the user to access Cisco CME and CallConnector features. Users can enter numbers from their telephone keypad to access these features.

For example, the user is on a call through the SNR service and they need to add in a colleague to the call. This can be accomplished by entering the 'Add Number' access code and the colleague's telephone number. If available, the number is joined to the call.

Users can also change their availability status and location using keypad access codes. This can not only inform colleagues of the user's status but can also be used to trigger previously setup Personal Routing Rules. For example if the user wants to be reached at their mobile phone they can change their location to "On the Road" to activate their "On the Road rule". The Mid-Call features can also be used to move the call from the current phone to another telephone instrument.

The following features can be accessed while on a SNR call:

- Add additional parties to the call.
- Allow the current call to leave a voice message by transferring the call the user's mailbox
- Transfer the current call to another number
- Transfer the current call to the use's work, home or mobile number
- Change the user's availability and location settings

Dial-in Access

The Mobility service Dial-In Access (DISA) allows users to access the Cisco CME features for their business calls when they are away from their office. To place long-distance or international calls, users can call in and use the business's telephones lines to place these calls. Users can also access the Cisco CME features such as setting up a multi-party conference call and more from their mobile or home phones. With DISA, the user can establish a phone conference from his/her mobile phone without access to the IP phone physically.

The following are some of the features available from the UCC Mobility Dial-In functionality:

- Make a business call from home or mobile phone utilizing the Cisco CME.
- Add additional parties in to the call or setup multi-party calls using the CME conference service
- Transfer the current call to their voice mailbox
- Transfer the current call to work, home, mobile, or custom phone number
- Change presence status and location

Remote PBX Call Transfer with UCC-Mobility

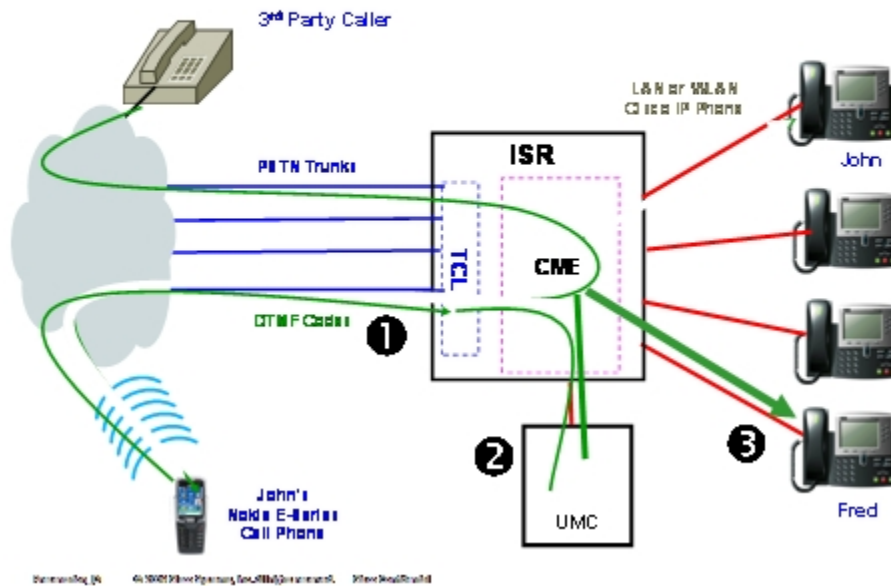

Call Flow for the Dial-In Access Service

1. A user dials in to a DISA number from his/her mobile phone and the UCC Mobility Service answers the call e.g. John's cell phone.
2. Depends on the DISA configuration settings, the UCC Mobility Service may or may not prompt the user for entering extension number or password to authenticate the user.
3. Once the user is authenticated, the user can place an outgoing call, for example to Fred's business phone. Fred will see the call placed from the business number, hiding the user's originating number.
4. Once on the call, additional parties can be added to form a multi-party conference.

The default key command mappings are listed in the following table:

Keys	Function	Description
*0	Help menu	The help menu describes the available options and the associated access codes.
*1	Change status	The Mobility Service announces your current status and then plays a menu of status change choices. You can make a selection from the key pad to update your availability status.
*2	Change location	The Mobility Service announces your current location setting and then plays a menu of location choices. You can select an option to update your location setting from any telephone.
*4	Transfer to a number	The prompt will ask you to enter a phone number and press # to transfer to the number. If you decide to cancel the operation after you have entered the number, you can press * to cancel.
*5	Add another party to the call	The prompt will ask you to enter a phone number and press # to add in the other party. If you decide to cancel the operation after you have entered the number, you can press *.
*6	Transfer to the user's mobile phone	This option will transfer the current call to the user's mobile phone number as provisioned for the user.
*7	Transfer to the user's work phone number	This option will transfer the call to the user's work phone number.
*8	Transfer to home phone	This option will transfer the call to the user's work phone number.
*9	Leave a voice message	This option will transfer the call to the on the user's voice mailbox to allow the caller to leave a message.
##	End Mid-Call Features or Dial-in Access session	It will terminate the Mid-Call Features or Dial-in Access session.
**	On Hold (for Share-Call Appearance only)	This option puts the call on hold. This call can then be picked up from the IP Phone by pressing the line button.

Switching the Call to the IP Phone

The CallConnector Mobility Service provides two methods from moving a call from the SNR number to the user's work phone. For users that have a 'shared appearance' configured on the Mobility Service, they can place the SNR call on hold and pick it up on the IP Phone by pressing the line button.

All other user on SNR calls can enter the 'transfer to work number' access code from their keypad. Their work number on the IP Phone will ring and can be picked up to resume the SNR call.

Simultaneous Ringing

When users set up their Personal Routing Policies, they can specify one or more phone numbers to be reached simultaneously to locate the users more efficiently. Therefore, the users can still be reached when they are out of office without missing any calls made to their work phones.

If users want to ring their work number as well as other personal reach numbers, the SNR service can be configured to call a secondary work number on their IP Phone. This requires a second ephone directory number to be configured on the user's IP Phone.

MOBILITY SERVICE FEATURE SUMMARY

Mobility Service System Features

Feature	Description
Allow mid-call to access features	Allows administrator to enable or disable Mid-Call features for callers after a SNR call is established. This is a system wide setting. Note: Mid-call features require CME hardware conferencing.
Maximum number of calls to locate users	Allows administrators to set the number to set the maximum number of simultaneous calls that can be made to locate a user. This is a system wide setting and can be used in configurations with constrained number of mobility-ephones.
Administrator settable reach out call answer timeout	Allows administrators to specify the timeout period (in seconds) for the SNR to hang-up the reach out call if the user does not answer. This is the time duration the Mobility Service will wait before dropping that call attempt.
Administrator settable maximum number of concurrent Single Number Reach calls	This is a administrator set parameter that limits the maximum number of SNR session can be established concurrently.
Queue for mobility-ephones	In the Single Number Reach service, when all mobility-ephones are in use, the Mobility Service waits and re-tries for mobility-ephones to become available.
Allow Dial-in system access	Allows administrator to enable or disable the Dial-In Access service to allow users to call in to and use the businesses telephone lines. This is a system wide setting.
Restrict to user contact numbers	Restrict the access to Dial-in Access service only from the numbers that are in the organization's corporate directory. With this restriction, users can dial in to the Mobility Service only from their contact numbers provisioned in the corporate directory that is their work, home and mobile numbers.
Authenticate with Dial-In password	This option enforces dial-in system access password authentication for all callers.

Show caller number for Single Number Reach calls	When the call is placed to user's reach numbers by the Mobility Service, the administrator can set options for displaying the caller number or a fixed number. If the "Show Caller's Number" is enabled then the user will see the caller's number in their caller-id display. This feature requires digital trunks.
Display caller number options for internal callers	For internally generated calls where the caller's number is less than certain digits (internal extension number), the administrator can configure the Mobility Service to either send a pre-defined PSTN number – such as the operator number or the Mobility Service number or where customers have DID capability append the prefix numbers to their extension number.
Support CME hardware or software conferencing	The CallConnector Mobility Service uses the CME conferencing facility for multi-party calls. When the CME is configured for software conferencing, minimum Mid-call and Dial-In features are available. The Cisco CME conferencing setting need to be reflected in the UCC Server configuration.
Shared or Dedicated ephone pools	The Mobility Service uses a set of ephones, referred to as the "mobility-ephones" that are configured for use for the various mobility generated calls. These ephones are grouped in to pools by the administrator. Multiple mobility-ephone pools can be provisioned. These mobility-ephone pools can be dedicated to a single Mobility Service such as Dial-In Access or shared among multiple Mobility Services.
Voice Mail Routing using Transfer Script, E164 VM Extension or Transfer Soft-key	<p>Several options are supported for returning the call to the user's voice mailbox. Cisco CME and Unity have to be configured to one of the following methods:</p> <ul style="list-style-type: none"> – Using Transfer Script uploaded to Unity (this is the recommended method). – E164 VM extension. Each voice mailbox requires a PSTN number configured in CUE. – Transfer to Voice-Mail soft key.
Provides prompt delay option for analog trunks that provide local call connect	Prompt messages can be delayed for analog trunks that provide local CME connect call state and do not provide remote end call progress information.

Pick-up and shared appearance methods for the Mobility Service access to the user's calls	The Mobility Service can be configured with shared appearance of user's work numbers. In this configuration, the Mobility Services acquires the call by answering it on the shared-appearance ephone. For users without a shared appearance number, the Mobility Service uses the CME call pickup feature to acquire the call.
Support for multiple routers	The Mobility Service can be configured to support users on multiple routers. This requires the UCC Server and the CME routers to be configured to send RADIUS events from each router to the UCC Server; mobility-ephones need to be configured from each router; CUE facilities need to be setup per router.
Single Voice Mailbox for the Single Number Reach calls	The Single Number Reach calls that cannot be connected to the user are returned to the Cisco Unity voice mail box. Each SNR user needs to have Cisco Unity mailbox setup on their router.
Support for multiple prompt language	The Mobility Service allows the administrator to select the prompting language. A set of pre-defined prompt files are shipped with the installation. Only one language can be selected. All prompts use the wave files from that language folder.
Support for custom prompts	The custom prompt facility allows the administrator to copy a set of language files to the custom language folder and modify one or more file according to the customer requirements.
Personal customized call routing policies	The routing of calls for the Single Number Reach service is individually customizable by each user. User's can setup up their own routing rules for when, for which calls and to which reach numbers the they are to be called.
Enable/Disable personal rules	The Personal Routing Rules can be enabled or disabled.
User authentication using personal PIN	User's can set their own Single Number Reach and Dial-In Access passwords.
Debug and Trace logging	Administrator can enable debug logging of the mobility services to allow problems to be isolated.
Diagnostic tools for viewing personal rules operation	A diagnostic tool is available to view the execution of the rules as the events are received and compared against the rules conditions.

Mobility Service User Features

Feature	Description
	Personal Routing Policies
Personalized custom call routing rules for Single Number Reach	UCC Mobility Service allows users to setup personalized call routing rules for handling the business calls when away from the desk.
User selectable extension numbers for SNR Service	Users can specify the primary or secondary extension on the IP Phone for the Single Number Reach service.
User specified reach numbers	If specified, the incoming calls will be routed to the user's work phone or 2 nd work phone or home phone or mobile phone or custom phone number.
Multiple simultaneous reach numbers	User can setup rules to try to reach them at multiple telephone numbers including home, mobile, and an alternate phone number.
Simultaneous ringing at IP Phone and alternate phone numbers	The Single Number Reach can be setup to ring the IP Phone and other numbers. However to ring at the IP Phone, a secondary DN needs to be configured and that number specified as one of the reach numbers
User's can selectively route callers to them using the single number reach	The mobility service can check if the caller's number is in the user's personal contacts or speed dial list or corporate directory or custom list of numbers.
Ability to enable/disable a rule	Multiple rules can be configured by the user and enabled or disabled as needed.
Call Routing can be conditionally based on the user's availability status	The mobility service can check if the user's current presence status is available or away or busy or unavailable to determine if the call is to be routed.
Call Routing can be conditionally based on the user's location	The mobility service can check if the user's current location at home, at work, on the road or on vacation to determine if the call is to be routed.
Different call routing rules for weekend, holiday and work-day	The mobility service can check if the day is a weekday, weekend, holiday or a particular day of the week to determine if the call is to be routed.

Different call routing rules for work hours, non-work hours or specified time	The mobility service can check if the current time is during work hours, after work hours or after a specified time to determine if the call is to be routed.
User specifiable SNR pickup delay time to allow the call to ring at the IP Phone	This answer delay (in seconds) can provide an option for the user to pick-up incoming calls before the Single Number Reach acquires the call.
	Personal Presence Update Policies
Update availability status based on date/time and/or other conditions	This allows the user to setup rules to automatically update their presence status to Available or Away or Busy or Unavailable based on the condition parameters available in the rules.
Update user's location based on date/time and/or other conditions	This allows the user to setup rules to automatically update their location to At Work, or At Home or On the Road or On vacation based on the condition parameters available in the rules.
Update the user's status message	User's status message can be updated to Busy or Be right back or Stepped out or Away from keyboard or On the phone or custom message.
	Access to Mid-Call/DISA Features
Add/Join another number	This allows the user while on a Mobility Service call to add another number to the call. Up to an additional five numbers can be added.
Transfer to a specified number	This allows the current call to be transferred to a specified number.
Transfer to the user's other phone number (home, mobile, work etc)	This allows the current call to be transferred to another one of the user's telephone number. This can be used to move the call from home to mobile or mobile to work or mobile to home phone numbers for more convenient call handling.
Transfer to Voice mail	The current call can be transferred to the Cisco Unity voice mailbox.
Make an outgoing call	This feature allows the user to dial in to the CallConnector Mobility Service and make an outgoing call using the telephone facilities of the organization. The user's caller id can be hidden or forwarded based on administrative settings.
Update Status	The user can call in and change their availability setting. This

	can be used to turn off one set of rules and enable another set, if the rules are based on the user's availability status.
Update Location	The user can call in and change their location setting. This can be used to turn off one set of rules and enable another set, if the rules are based on the user's location setting.

SETTING UP PERSONAL MOBILITY SERVICE

Each user needs to setup one or more rules or policies that specify to the Mobility Service which of the user's incoming business calls are to be forwarded to the specified user's numbers.

This chapter provides a step-by-step tutorial on how to setup Single Number Reach rules for Cisco CallConnector Mobility Service. Examples of several user Single Number Reach rules are described.

The general steps for adding a new personal custom rule include the follow steps:

- Step 1.** Launch Internet Explorer or Outlook and open the CallConnector Contact window.
- Step 2.** Click on **Rules** tab in the Contacts window.
- Step 3.** Create a new rule and assign a user friendly name for the rule.
- Step 4.** Check **Enable This Rule** option.
- Step 5.** Enable at least one condition and set the parameters for each condition enabled.
Note: For Single Number Reach rules the condition "If a call comes to this number" must be set.
- Step 6.** Enable the Single Number Reach service and selected the numbers that will be called.
- Step 7.** Click **Finish** to exit.

Once a rule has been created, it can be enabled or disabled. 'Disabled' rules are rules that are configured but not active.

The Mobility Service only monitors conditions for the rules that are "Enabled". A rule can be enabled/disabled from the button at the bottom of the Rules Window and from the right-click menu.

Setting up a Single Number Reach Rule:

To create a new Single Number Reach (SNR) rule:

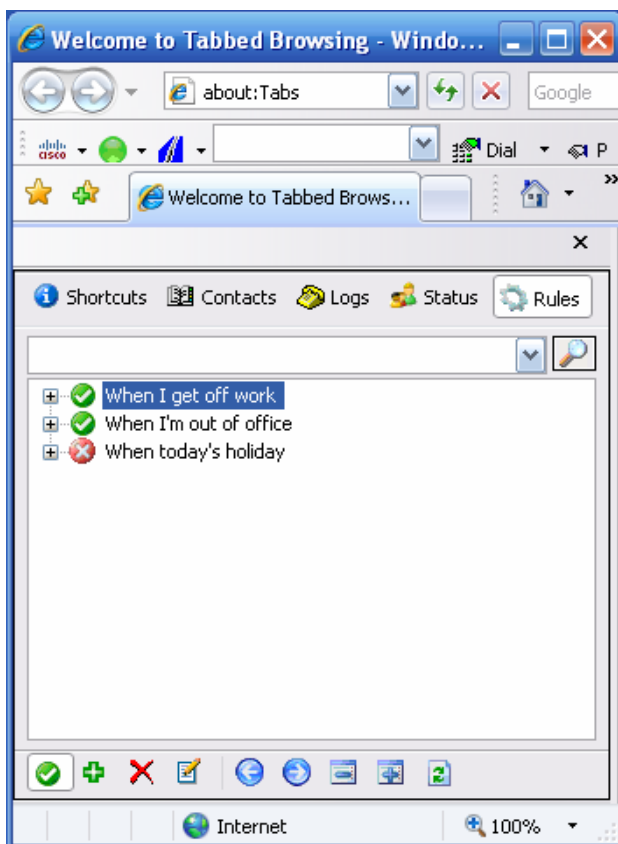

Rules Window in Internet Explorer showing user's call routing rules

- Launch Internet Explorer or Outlook and open the Cisco CallConnector Contacts window to the Rules section.
- Click on  button and a “Manage Rule” window will pop up for you to create the SNR rule.
- Enter a name for the SNR rule and check the “Enable This Rule” option.
- Click on the “Conditions” tab to setup desired condition checks.

Options	Description
Name	Assign a name to identify the rule.
Enable This Rule	Check to enable/Uncheck to disable the rule.







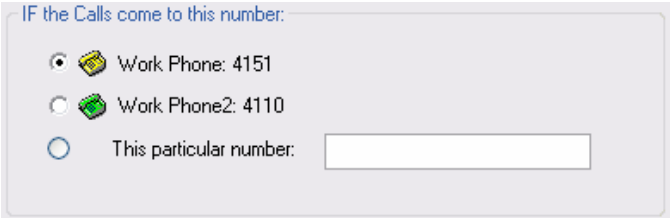
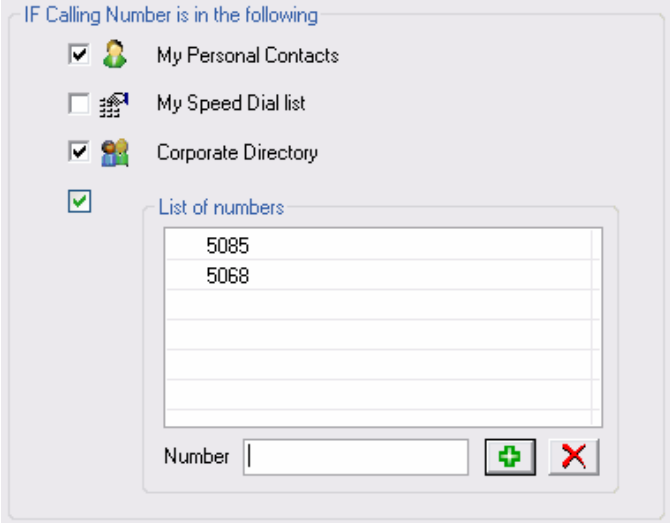

Managing Rule Summary Window

This following table shows you various condition checks that you can set for the SNR rule. There are three main categories of condition.

- Check the incoming call parameters
 - The user's extension number that was called. Note: This must be selected.
 - Specify which caller is to be forwarded (Optional condition).
- Check the user's availability (Optional conditions)
 - Current status
 - Current location
- Check the date/time (Optional conditions)
 - Is holiday, workday, or weekend
 - Is working hour

Setup Single Number Reach Conditions:

Check the Incoming Call Conditions	
<p>IF the Calls come to this number:</p>  <p><i>If the calls come to my Work Phone (4151) then launch the SNR.</i></p>	<p>IF the Calls come to this number:</p> <p>Users can specify that an incoming call to one of the following phone numbers will trigger the SNR service.(Note: all selected conditions for the rule have to be true)</p> <ul style="list-style-type: none"> • Work phone • Work phone 2 • Particular extension number <p>Note: All the numbers have to be CME extensions that are in the CallConnector corporate directory.</p>
<p>IF Calling Number is in the following</p>  <p><i>If the Calling Number is in My Personal Contacts, or in the Corporate Directory, or the List of Numbers (5085&5068) then launch the SNR.</i></p>	<p>IF Calling Number is in the following:</p> <p>You can select one or more of the following contact phone numbers as the condition check criteria.</p> <ul style="list-style-type: none"> • My Personal Contacts • My Speed Dial List • Corporate Directory • List of numbers <p>Note: This condition allows users to filter or select certain callers to be forwarded using the SNR service. Other calls receive the CME not-available routing. The caller's number is matched against the specified lists, only if the number is that of the contact numbers (home, work or mobile) then this condition is true</p>

Check Availability Conditions	
<p>IF my Status is:</p> <div style="border: 1px solid #ccc; padding: 5px; background-color: #f0f0f0;"> <input type="checkbox"/>  Available <input checked="" type="checkbox"/>  Away <input checked="" type="checkbox"/>  Busy <input type="checkbox"/>  Unavailable </div> <p><i>If my presence status is Away or Busy then launch the SNR.</i></p>	<p>IF my Status is:</p> <p>You can select one or more of the following presence location as the condition check criteria.</p> <ul style="list-style-type: none"> • Available • Away • Busy • Unavailable
<p>IF my Location is:</p> <div style="border: 1px solid #ccc; padding: 5px; background-color: #f0f0f0;"> <input type="checkbox"/>  At Home <input type="checkbox"/>  At Work <input checked="" type="checkbox"/>  On the Road <input checked="" type="checkbox"/>  On Vacation </div> <p><i>If my current location is On the Road or On Vacation then launch the SNR.</i></p>	<p>IF my Location is:</p> <p>You can select one or more of the following presence location as the condition check criteria.</p> <ul style="list-style-type: none"> • At Home • At Work • On the Road • On Vacation

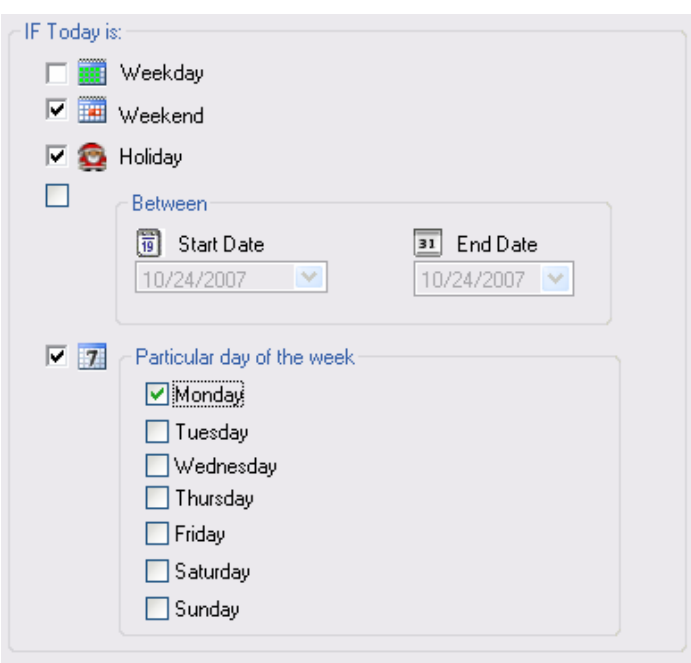
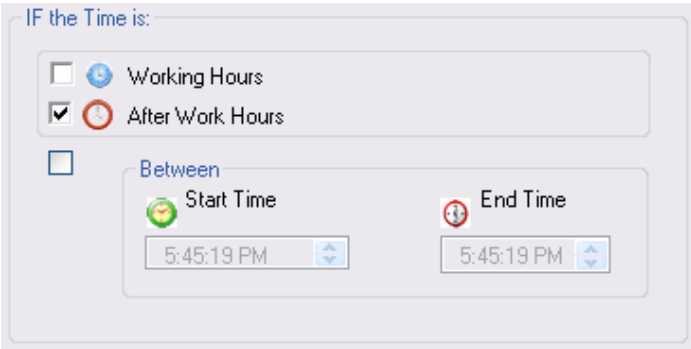
Check the Date/Time Conditions	
 <p>IF Today is:</p> <ul style="list-style-type: none"> <input type="checkbox"/> Weekday <input checked="" type="checkbox"/> Weekend <input checked="" type="checkbox"/> Holiday <input type="checkbox"/> Between <ul style="list-style-type: none"> Start Date: 10/24/2007 End Date: 10/24/2007 <input checked="" type="checkbox"/> Particular day of the week <ul style="list-style-type: none"> <input checked="" type="checkbox"/> Monday <input type="checkbox"/> Tuesday <input type="checkbox"/> Wednesday <input type="checkbox"/> Thursday <input type="checkbox"/> Friday <input type="checkbox"/> Saturday <input type="checkbox"/> Sunday <p><i>If Today is Weekend, Holiday or Monday then launch the SNR.</i></p>	<p>IF Today is:</p> <p>The user can select one or more of the following days as the condition check criteria.</p> <ul style="list-style-type: none"> • Weekday • Weekend • Holiday • Between Start and End Date • Particular day of the week <p>Note: Holidays and Weekday/Weekend days are configured by the administrator.</p>
 <p>IF the Time is:</p> <ul style="list-style-type: none"> <input type="checkbox"/> Working Hours <input checked="" type="checkbox"/> After Work Hours <input type="checkbox"/> Between <ul style="list-style-type: none"> Start Time: 5:45:19 PM End Time: 5:45:19 PM <p><i>If the Time is After Work Hours then launch the SNR.</i></p>	<p>IF the Time is:</p> <p>The user can select one or more of the following time as the condition check criteria.</p> <ul style="list-style-type: none"> • Working Hours • After Work Hours • Between Start and End Time

Setup Single Number Reach Actions:

In this last step, the user has to specify the actions that will be automatically performed by the CallConnector system once all the condition checks are passed.

Users can set a delay interval (in seconds) to allow the IP Phone to ring before the SNR picks up the incoming call in the case where you don't want the SNR to launch right away. The numbers at which the user wants to be reached for the incoming call needs to be selected. If the user is not reachable on the specified numbers then the caller is be transferred to user's voicemail box. The mailbox information is displayed at the bottom of the Action window. Note the mailbox and PIN password can be configured from the Popup-Options window.

Enable this action

Single Number Reach

Pick up and route the incoming call that is specified in the 'Check Calls come to' condition.

Delay before pick up the incoming call: (default: 0 second)

Delay time: seconds

The incoming call will be routed to:

Work Phone: 4110

Work Phone2: 5085

Home Phone: [No Data]

Cell Phone: [No Data]

Other

In case I couldn't be reached, the incoming call will be transferred to voice mail:

Mail box password

(Voice mail account info is retrieved automatically from user's profile)

(Note: Some of the options for routing the incoming call will be disabled if they're already selected in the Check Calls condition)







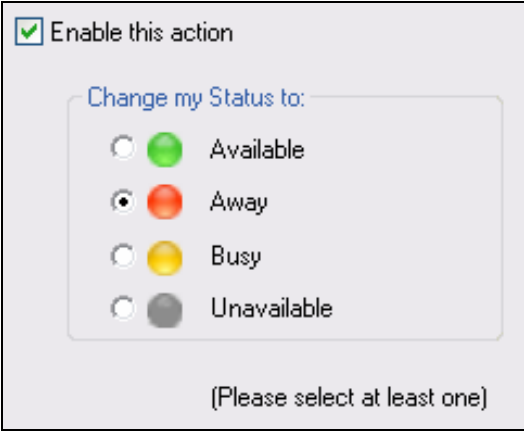

Single Number Reach Actions Parameters

Options	Description
Delay time	The delay interval (in Seconds) before the SNR picks up the call.
The call will be routed to	Phone numbers that will be reached from the incoming call.
Mailbox (Read only)	In case you couldn't be reached, the incoming call will be transferred to your voicemail box.
Password (Read only)	Your SNR password.

Setup Status Update Actions:

In addition to the Single Number Reach actions, users can also setup rules to automatically change their availability, location and away messages based on user specified conditions.

Automated Status and Location Updates	
 <p>Update status to Away.</p>	<p>When enabled and the conditions are met:</p> <p>The user's availability status is changed to the selected status</p> <ul style="list-style-type: none"> • Available • Away • Busy • Unavailable <p>Note: This can be used in combination with the date/time conditions to automatically change the user's status</p>

<div data-bbox="228 233 794 611"> <input checked="" type="checkbox"/> Enable this action <p>Change my Location to:</p> <ul style="list-style-type: none"> <input type="radio"/>  At Home <input type="radio"/>  At Work <input checked="" type="radio"/>  On the Road <input type="radio"/>  On Vacation <p>(Please select at least one option)</p> </div> <p data-bbox="228 632 794 663">Update user's location to 'On the Road'</p>	<p>When enabled and the conditions are met:</p> <p>The user's location setting is changed to the specified location</p> <ul style="list-style-type: none"> • At Home • At Work • On the Road • On Vacation <p>Note: This can be used in combination with the date/time conditions to automatically change the user's location</p>
<div data-bbox="228 741 930 1108"> <input checked="" type="checkbox"/> Enable this action <p>Change my status Message to:</p> <ul style="list-style-type: none"> <input type="radio"/>  Busy <input type="radio"/>  Be right back <input type="radio"/>  Stepped out <input type="radio"/>  Away from keyboard <input type="radio"/>  On the phone <input checked="" type="radio"/> Custom message: <input type="text" value="In the meeting"/> <p>(Please select one)</p> </div> <p data-bbox="228 1171 930 1203">Update user's away message to 'In a meeting'</p>	<p>When enabled and the conditions are met:</p> <p>The user's away message is changed to the specified option</p> <ul style="list-style-type: none"> • Busy • Be right back • Stepped Out • Away from keyboard • On the Phone • User entered custom message

Examples of Single Number Reach Rules

This section describes some common rules that can be configured by the users.

Send my Business Calls to my Mobile phone

This is a simple, unconditional rule that when enabled, tries to connect the incoming calls to the user's IP Phone to the users mobile phone. If the user is not available then the call is routed to the voice mailbox.

Rules Window View:

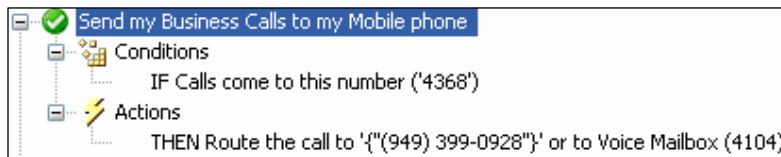

Rules Wizard Settings:

Manage Rule

Summary | Conditions | Actions

Conditions

Check the Calls

IF Calls come to this number ('4368')

IF Calling Number is in...

Check my Availability

IF my Status is...

IF I am at this Location...

Check the Date/Time

IF current Day is...

IF current Time is...

Enable this condition (required by the SNR action and check Calling Number condition)

IF the Calls come to this number:

Work Phone: 4368

Work Phone2: (949) 399-0927

This particular number:

(Please select at least one option)

Some options may be disabled if they already are selected in the 'Single Number Reach' action (see the 'The incoming call will be routed to' section of SNR).

- Dependencies:

- + This condition is required by the 'Single Number Reach' action.
- + This condition is required by the 'Check Calling Number' condition.

Previous Next Finish Cancel

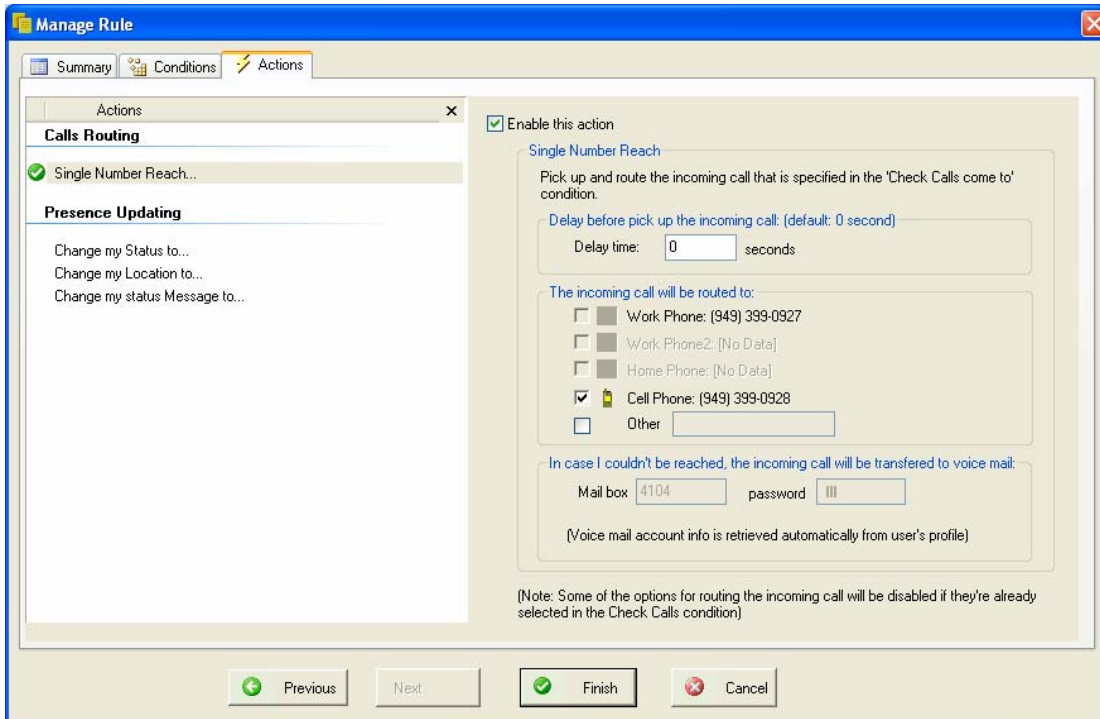

Working from Home Rule

When I am working from home, send my business calls to my home phone number.

This rule checks the user's availability status and their location. If the user is "At Home" and the availability status is "Available", then the incoming calls to the IP Phone are sent to the home number. The users can receive the work calls at their home number. They can control the call flow by changing their availability status – Busy or Unavailable setting will stop the delivery of business calls.

Note: The users can receive calls at home without having to give out the home number.

Rules Window View:

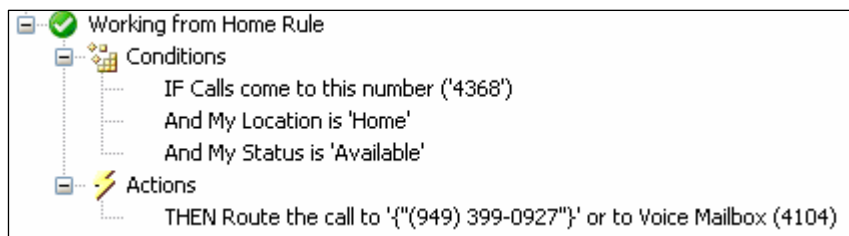

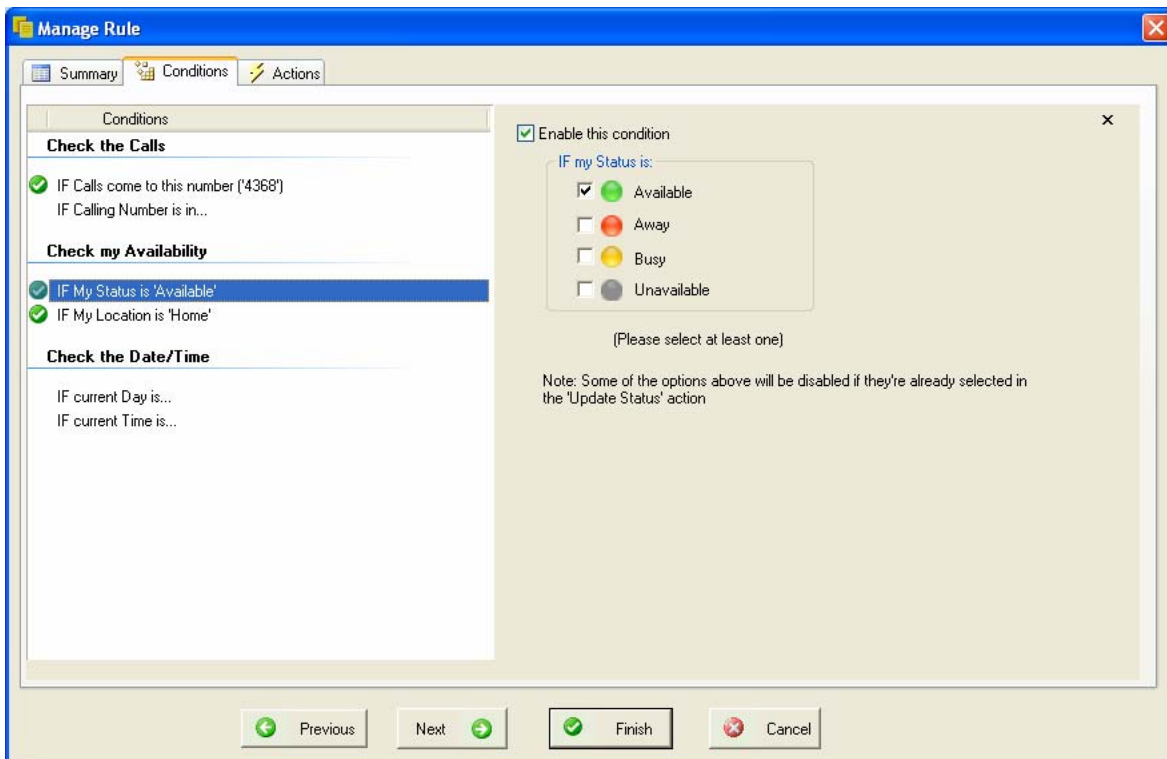
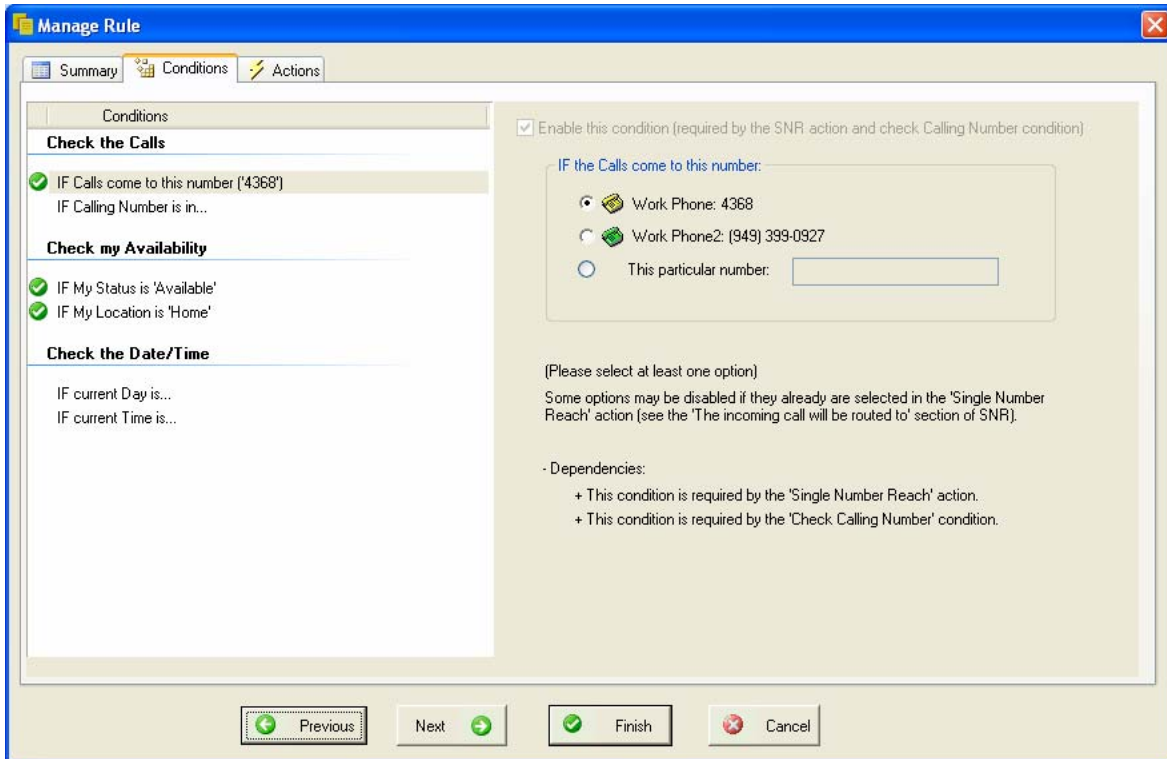

Manage Rule

Summary Conditions **Actions**

Conditions

Check the Calls

- IF Calls come to this number ('4368')
- IF Calling Number is in...

Check my Availability

- IF My Status is 'Available'
- IF My Location is 'Home'

Check the Date/Time

- IF current Day is...
- IF current Time is...

Enable this condition

IF my Location is:

- At Home
- At Work
- On the Road
- On Vacation

(Please select at least one option)

Note: Some of the options above will be disabled if they're already selected in the 'Update Location' action

Previous Next Finish Cancel

Manage Rule

Summary Conditions **Actions**

Actions

Calls Routing

- Single Number Reach...

Presence Updating

- Change my Status to...
- Change my Location to...
- Change my status Message to...

Enable this action

Single Number Reach

Pick up and route the incoming call that is specified in the 'Check Calls come to' condition.

Delay before pick up the incoming call: (default: 0 second)

Delay time: seconds

The incoming call will be routed to:

- Work Phone: 4368
- Work Phone2: (949) 399-0927
- Home Phone: (949) 399-0927
- Cell Phone: (949) 399-0928
- Other

In case I couldn't be reached, the incoming call will be transferred to voice mail:

Mail box password

(Voice mail account info is retrieved automatically from user's profile)

(Note: Some of the options for routing the incoming call will be disabled if they're already selected in the Check Calls condition)

Previous Next Finish Cancel

Call Routing Outside Work Hours

Outside of work hours but only on working days, route the user's business calls to the mobile phone.

Rules Window View:

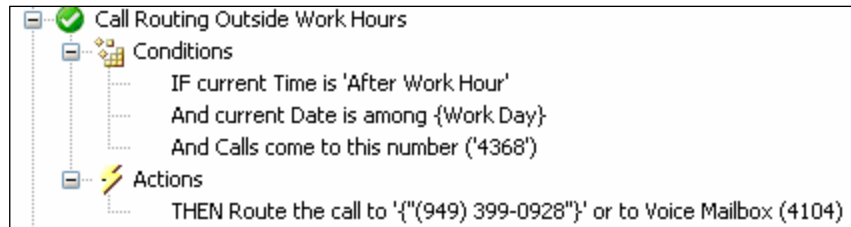

Rules Wizard Settings:

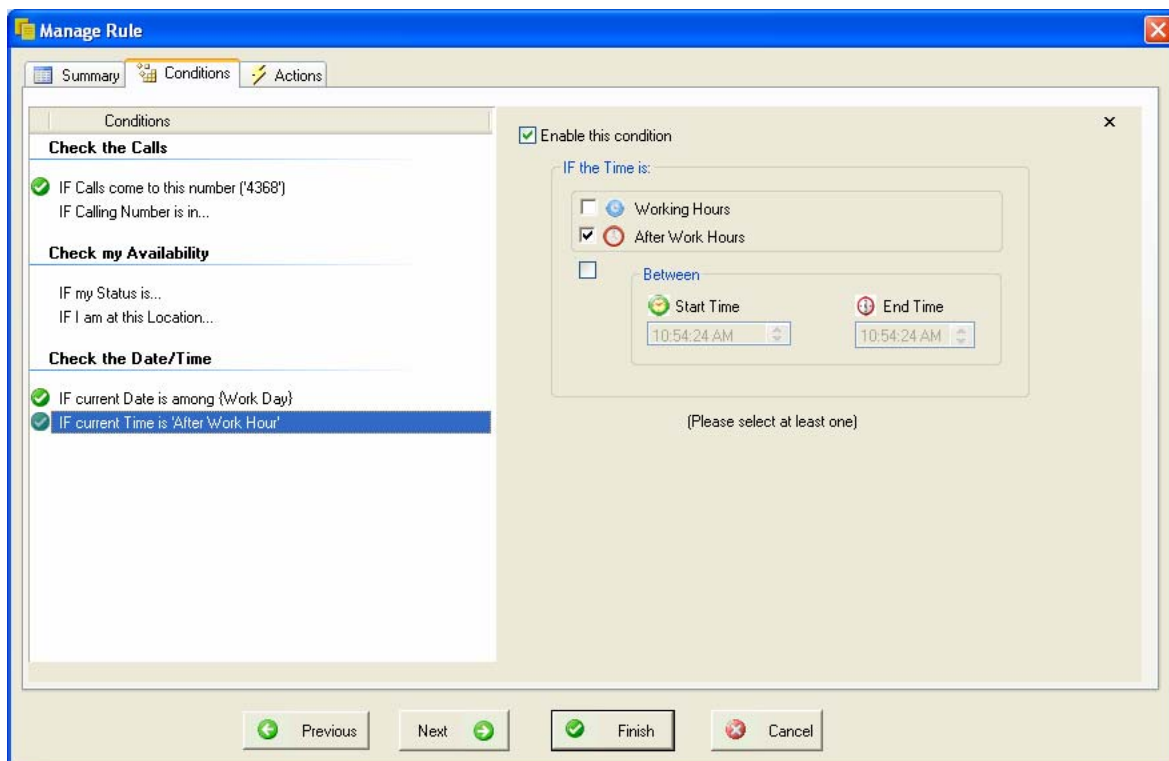

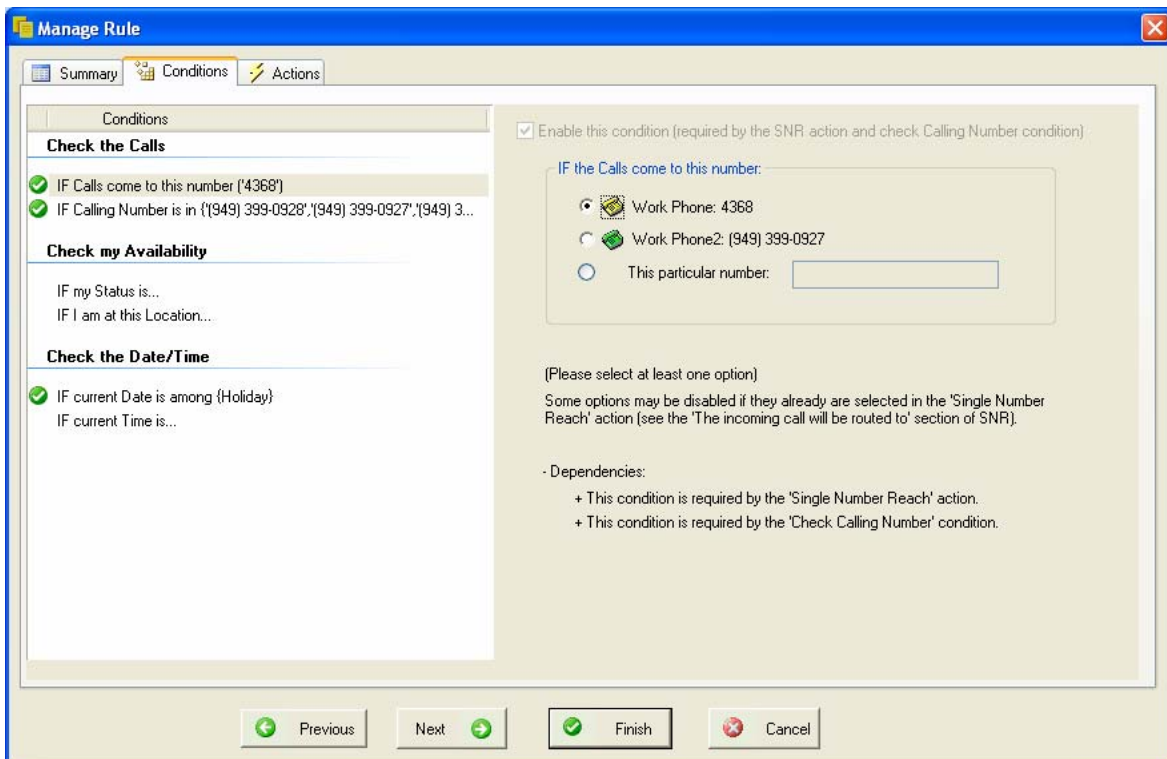
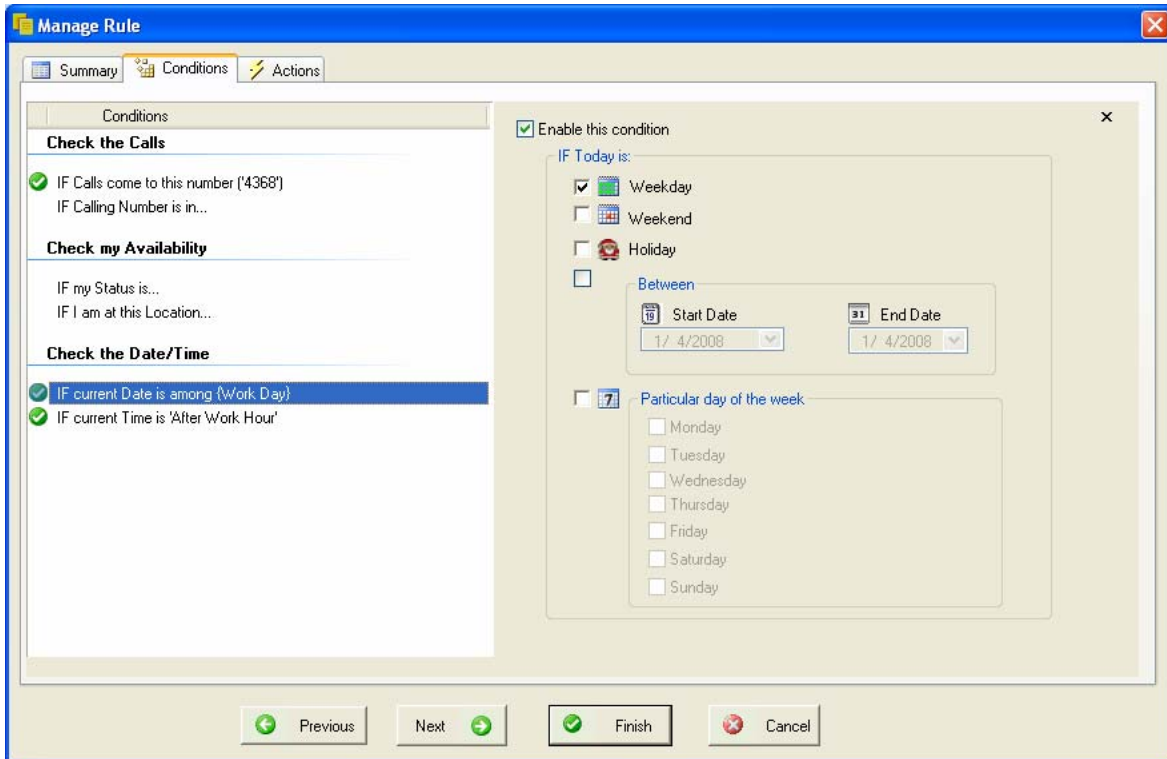

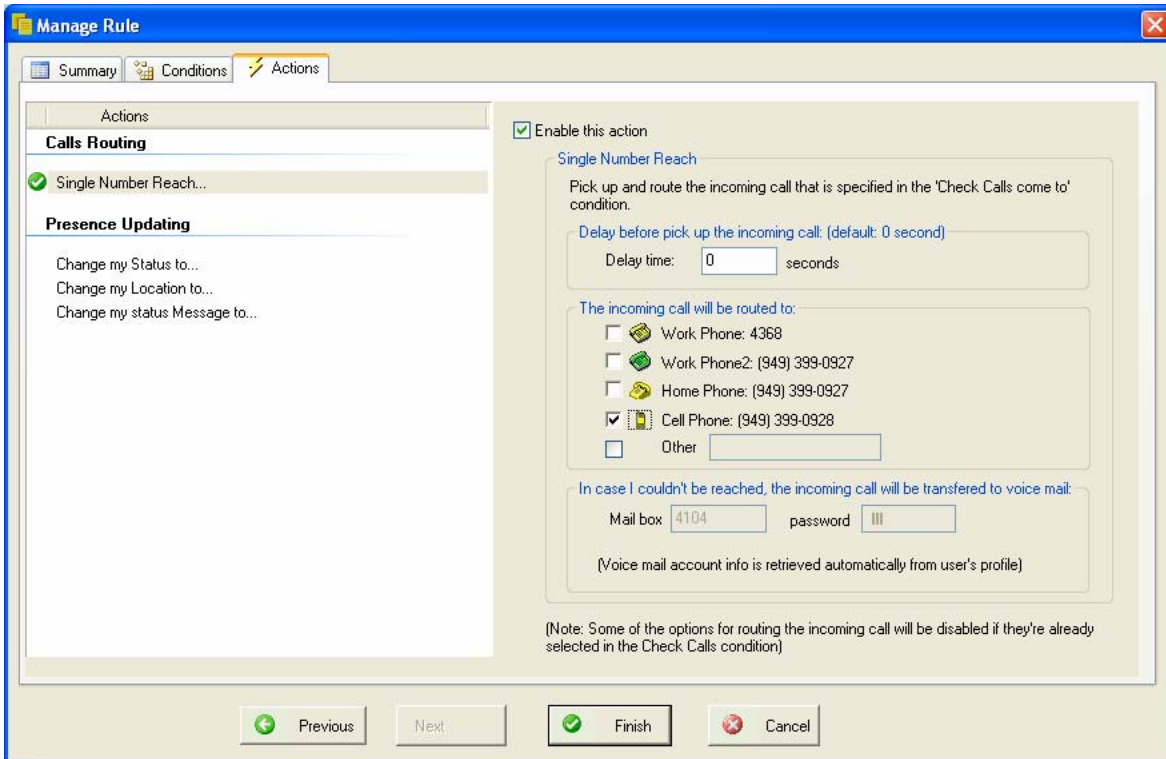

Call Routing when traveling on business

When on the road, send the business calls to the mobile phone.

Rules Window View:

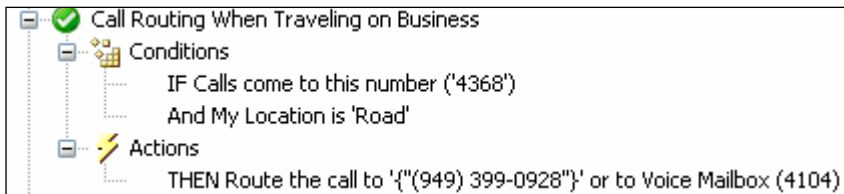

Rules Wizard Settings:

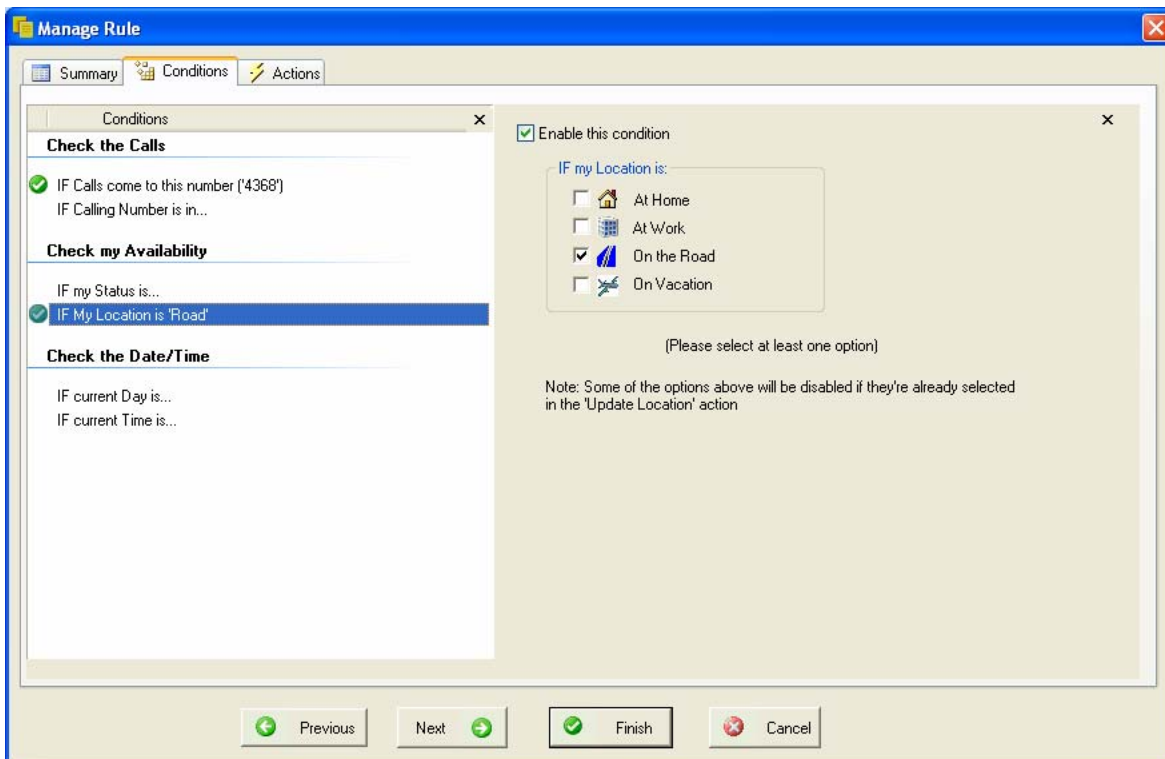
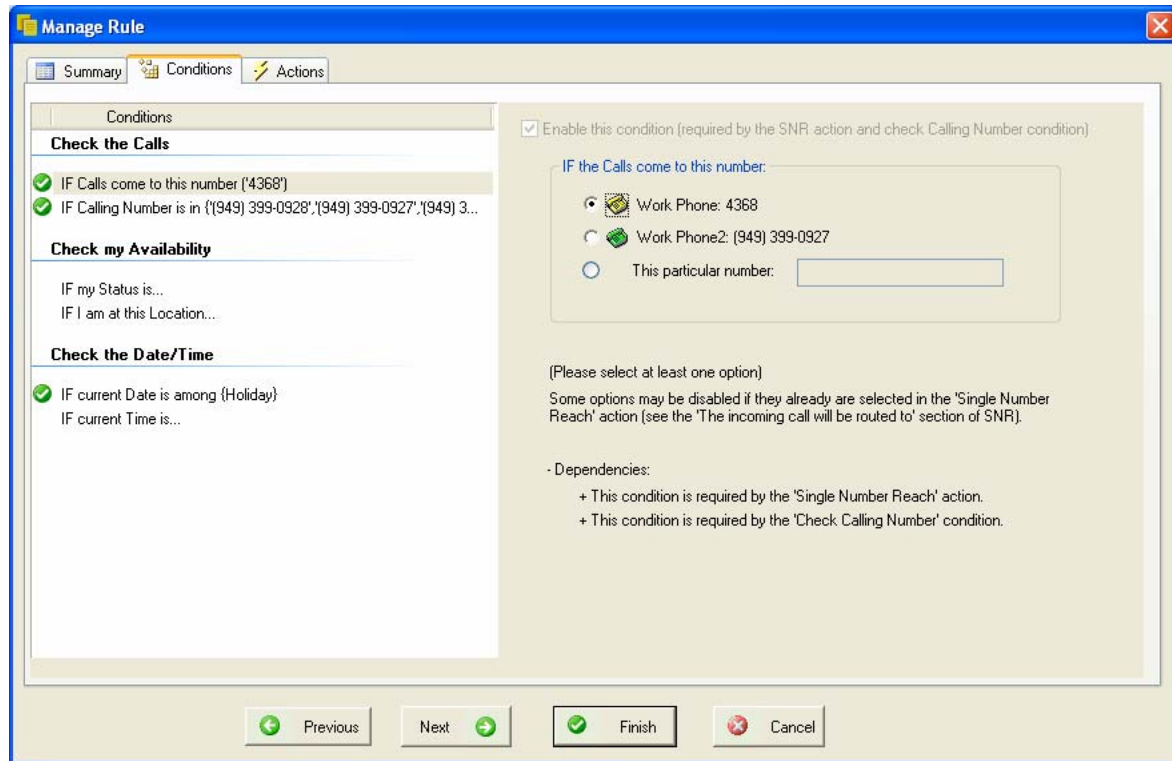

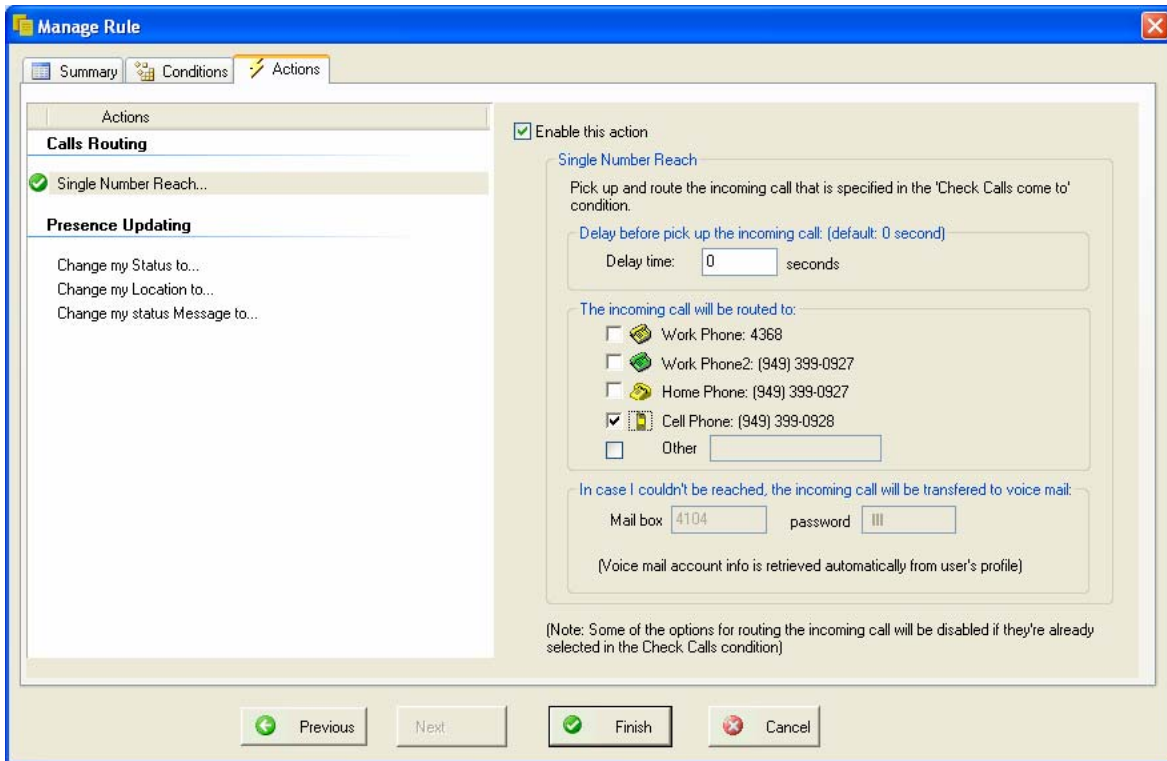

Priority Interruptions When on Holiday

When on holiday, send only selected callers to the user’s mobile phone.

Rules Window View:

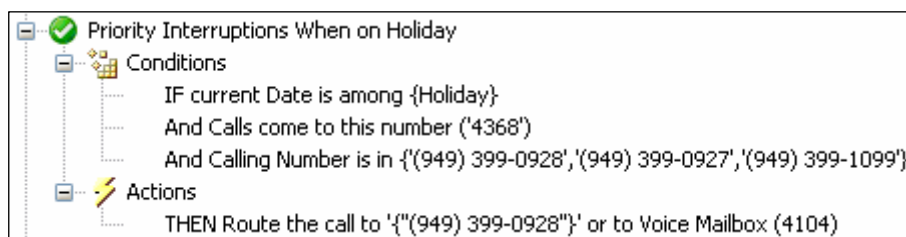

Rules Wizard Settings:

Manage Rule

Summary Conditions Actions

Conditions

Check the Calls

- ✓ IF Calls come to this number ('4368')
- ✓ IF Calling Number is in {'(949) 399-0928','(949) 399-0927','(949) 3...

Check my Availability

- IF my Status is...
- IF I am at this Location...

Check the Date/Time

- ✓ IF current Date is among {Holiday}
- IF current Time is...

Enable this condition (required by the SNR action and check Calling Number condition)

IF the Calls come to this number:

- Work Phone: 4368
- Work Phone2: (949) 399-0927
- This particular number:

(Please select at least one option)

Some options may be disabled if they already are selected in the 'Single Number Reach' action (see the 'The incoming call will be routed to' section of SNR).

- Dependencies:

- + This condition is required by the 'Single Number Reach' action.
- + This condition is required by the 'Check Calling Number' condition.

Previous Next Finish Cancel

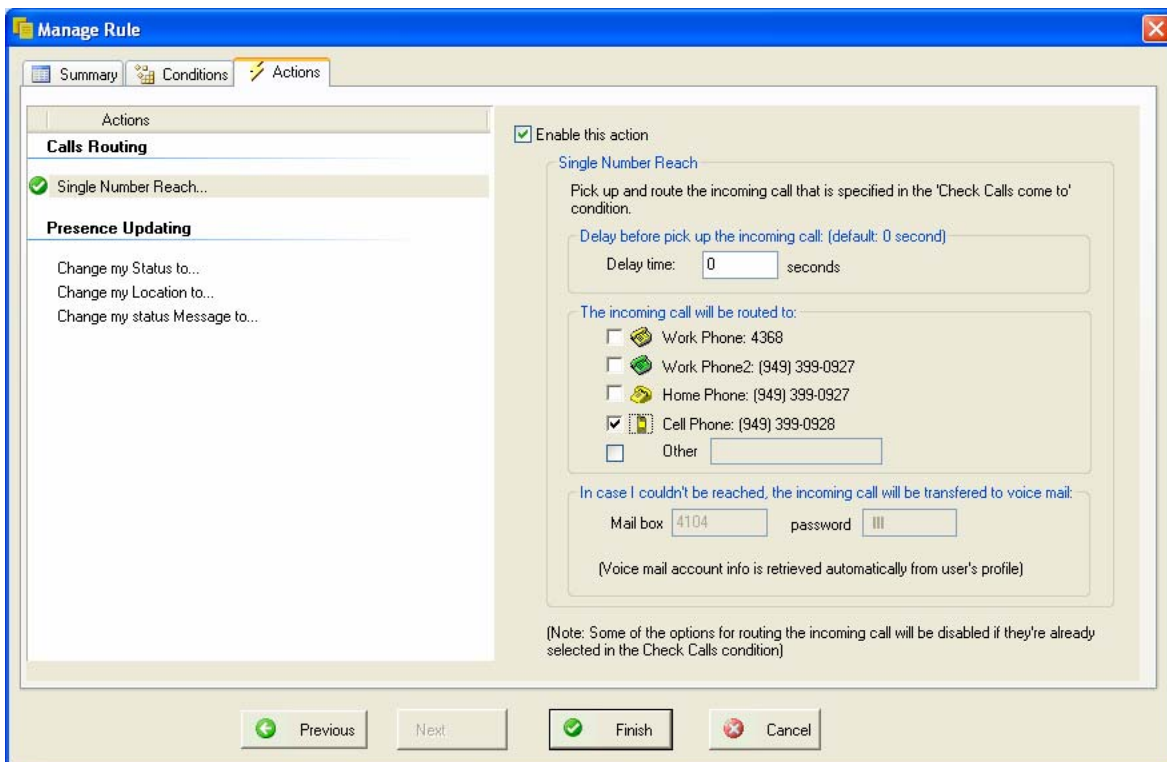
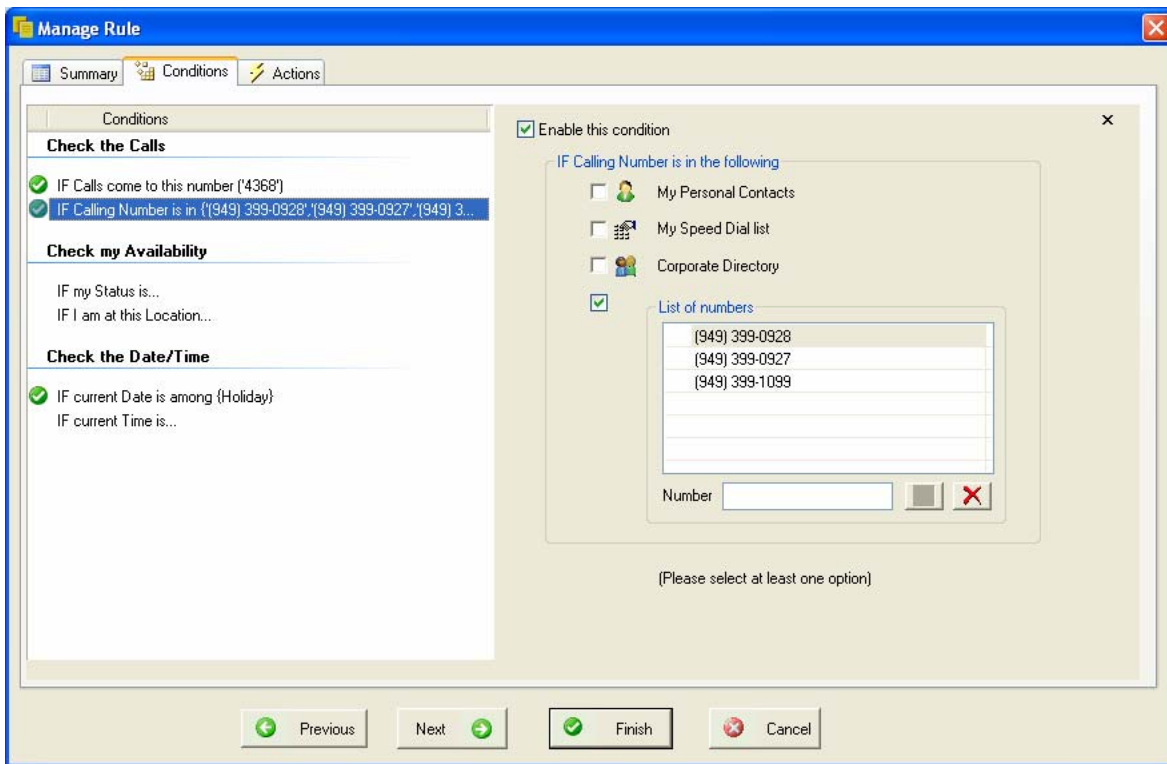

INSTALLATION

This section describes the installation process including the location of the install files and the system requirements for the Mobility Service.

Since the Mobility Service is an add-on function of the Unified CallConnector Server, you will need to install the Unified CallConnector Server with Mobility Service. This installs both the UCC Server functionality and the Mobility Service applications. If you are already running the UCC Server, then you will need to upgrade to the UCC Server with Mobility Service.

In both cases, you will need to:

- Download the Unified CallConnector Server with Mobility Service installation software from the Cisco site. (You need a CCO account to download this software)
- Obtain a license number for UCC Mobility Service (and for the UCC Server if you do not have one).
- Prepare a Windows server computer that meets the minimum performance requirements for you configuration. You will need an administrative account on this server.
- Run the installation software to load the UCC files and data to the Windows Server computer. Restart the computer.
- Register the Mobility Service license with the UCC License Server. This requires access to the Internet. (Note the UCC Server will also have to be licensed and registered independently of the Mobility Service)
- Both the CME and the UCC Server need to be configured for proper operation of the Mobility Service. See the next chapter for details.
- Note: You will also need to install or update the UCC clients to the latest revision level of the software or at the minimum to the same version as the UCC Server.

Detailed instructions for the installation of the UCC Server and Mobility Service software is provided in Chapter 3 of the Unified CallController Server Administration Guide.

Installation Files

Files	Location
UCC Server with Mobility Service	100 MB free hard drive space for server; Reserve additional 100 MB for upgrades
File Download Site	http://www.cisco.com/cgi-bin/tablebuild.pl/callconnector-ms

MOBILITY CONFIGURATION OVERVIEW

The Mobility Service makes use of additional features of the Cisco CME and Cisco CUE. These features have to be provisioned on the CME and CUE and then the corresponding parameters have to be configured on the UCC system. In this chapter, the CME and CUE setup requirements are discussed followed by the UCC Server configuration. It provides a step-by-step tutorial on how to setup the environment for Cisco CallConnector Mobility Service to work.

CME/CUE Setup Requirements

Setting on CME/CUE to support UCC Mobility – Single Number Reach Service

- Set up Radius accounting parameters to send messages to UCC Server
- Provision Mobility ephones on CME for use by the Mobility Service
- Setup Hardware Conferencing including Ad-Hoc conferencing
- Upload CUE Transfer to voicemail script and setup pilot numbers
- Provision a hunt group to route calls to mobility ephones for DISA features (for DISA only)

Steps to Configure Mobility Single Number Reach Service on UCC

- Configure CME location, features settings and dialing rules
- Select the mobility-ephones previously configured in the CME
- Configure Single Number Reach system parameters.
- Setup ephone pools for the Single Number Reach Service.
- Assign ephones to the ephone pools that'll be used by the SNR Service.
- Configure user contact information including the voicemail box and SNR PIN.

Additional Steps to Configure Dial-In Service on CME and UCC

- Select the additional Mobility ephones configured in the CME for the DISA feature.
- Configure Dial-In Access system parameters.
- Setup ephone pools for the Dial-In Access service.
- Assign ephones to the ephone pools that'll be used by the DISA Service.
- Configure user contact information including the DISA password.

CME/CUE Setup Summary for Mobility Service

Function	What needs to be setup
Radius Accounting Parameters	<p>RADIUS messages can be generated by CME for calls that originate or terminate on the CME endpoints. The UCC system uses these messages to obtain the call state and calling/called numbers. The UCC Server includes the RADIUS server functionality and requires the CME to be setup to send the RADIUS messages of the required format, type and frequency. The section on 'Setting Up Radius Accounting' provides details on the CME setup, UCC configuration and verifying that the messages are being received.</p>
Mobility ephones and ephone-DN	<p>The Mobility Service uses ephones for answering the Single Number Reach calls and for making the reach out calls. These ephones need to be configured in the CME and then selected and associated with the Mobility application using the Server Wizard.</p> <p>The mobility-ephones have specific attributes:</p> <ol style="list-style-type: none"> A 'virtual MAC-address' is assigned to each mobility-ephone. Each ephone needs to have at-least three single-line ephone-DN configured Ephones need to have Ad-hoc conference control capability <p>Note: In multiple router configurations, mobility-ephones have to be provisioned from each of the routers as the Mobility Service uses ephones that are on the same router as the user's ephone.</p>
CME Conferencing Options	<p>The Mobility Service uses the CME conferencing feature to bridge the caller and user calls. Both hardware and software conferencing is supported by the Mobility Service. However hardware conferencing is required for the Mid-call and DISA features. If hardware conferencing is enabled on the CME, then ad-hoc conferencing has to be configured for use by the mobility-ephones.</p>

Transfer to Voice Mail	<p>When a user cannot be reached at the specified numbers, the call is sent to the user's voice mailbox. A voice mail box must be configured for each user with SNR service. Additionally the CME and CUE have to be setup to allow the transfer of the call directly into the user's voice mailbox. Several methods for transferring a call to a user's voice mail are supported by the Mobility Service. The most common method uses the Transfer-to-Voicemail script. This script has to be uploaded to CUE and configured through the CUE administration interface. On the CME side a dial-peer has to be setup with a 'Transfer-Pilot Number' to send to call to the CUE Transfer-to-Voicemail' script.</p>
Hunt Group for the DISA numbers	<p>The Mobility Service DISA feature use ephones to receive, authenticate and provide CME feature access to the UCC user. Since multiple ephones are normally configured for DISA, a hunt group with a pilot number pointing to the primary ephone-DN on each of these ephones needs to be setup in the CME to route the DISA callers to the mobility ephones. The hunt group can be setup to sequentially hunt for an idle ephone-DN.</p> <p>Note: The hunt group list should include only the primary ephone-DN from each of the DISA mobility ephones.</p>
Additional Mobility ephones and ephone-DN for the DISA service	<p>The Mobility DISA service can be setup to share the ephones from a general pool with the SNR feature or it can have a set of ephones dedicated to this service. Sufficient numbers of mobility-ephones need to be configured for the required traffic levels.</p>

Configuration for SNR Service - Summary

Single Number Reach	What needs to be setup
Configure CME location, features and dialing rules	For each CME associated with the UCC server, the location, extension lengths and dial-out access codes need to be configured to allow proper formatting of numbers for dialing. Additional dialing rules can be configured to manipulate the numbers for dialing and lookup if required for the location.
Select Mobility ephones for the SNR Service	This configuration step specifies to the UCC system, the ephones that have been configured in the CME for use by the Mobility Service. These ephones must have the option 'Connect as Softphone' checked and must be configured with a virtual MAC-address.
Configure SNR System parameters	<p>The administrator can set a number of system wide parameters for the Single Number Reach service. These include:</p> <ul style="list-style-type: none"> a. Maximum number of reach out calls for each user b. Maximum number of concurrent SNR sessions c. Answer timeout --- the maximum wait time for a call to be answered d. Enable/Disable the Mid-call features <p>In addition the administrator can set the caller-id transmission rules.</p>
Setup holidays and work hours	The administrator can setup a schedule for the holidays observed and the working hours (start and end times) and the working days for the organization.
Setup ephone pools for SNR Service	The ephones that have been configured for the Single Number Reach service need to be associated with the SNR application. This is performed by creating groups or pools of ephones and allocating them to the mobility applications
Update user contact information for voice mail box and SNR PIN number	For the Single Number Reach service, the users need to have the voice mail box and the SNR PIN or password configured. User's can update this information from their Popup application Options window.

Configuration for DISA Service - Summary

Dial-IN Access	What needs to be setup
Select the additional Mobility ephones for the DISA Service	This configuration step specifies to the UCC system, the ephones that have been configured in the CME for use by the Mobility Service. These ephones must have the option 'Connect as Softphone' checked and must be configured with a virtual MAC-address.
Configure DISA System parameters	<p>The administrator can set a number of system wide parameters for the Dial-In Access service. These include:</p> <ol style="list-style-type: none"> a. Enable/Disable the Dial-In Access b. Restrict only to calls from telephone numbers configured UCC Corporate directory c. Always require Dial-In password d. Specify the pick-up numbers or use the DISA ephone-DNs <p>In addition the administrator can set the caller-id transmission rules for DISA.</p>
Setup ephone pools for DISA Service	The ephones that have been configured for the Dial-In service need to be associated with the DISA application. This is performed by creating groups or pools of ephones and allocating them to the mobility applications

Multiple Routers for UCC Server

A single UCC Server can be shared by users on multiple Cisco CME systems.

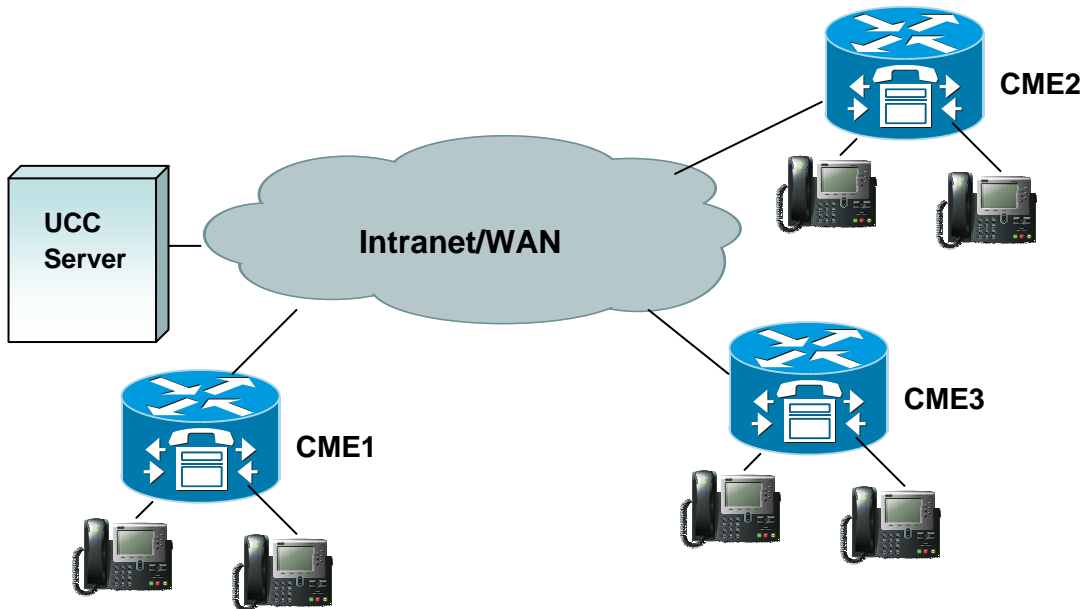

There are a number of configuration rules and network requirements for such multi-router systems.

Configuration	Description
Maximum Number of Routers	It is recommended that no more than 5 ISR/UC500 routers be connected to the UCC Server
Maximum number of users per UCC Server	The maximum number of users per UCC Server is 250 users
TCP/UDP Control Messages	Network must provide bandwidth and minimum latency for the control messages. RADIUS messages are transmitted as UDP messages. TCP sessions are used to transport the SCCP/Skinny messages between the CME router and the UCC Server
UDP Media for RTP messages	Calls handled by UCC Mobility Service include the SNR and DISA calls. The media for these calls flows from the CME router with the PSTN Gateway to the UCC Server. The UCC Server only supports G.711 codecs (64 KBPS for each voice direction)

Network Bandwidth Requirement	<p>If the routers are in different locations connected via private network, the network should have sufficient capacity to support:</p> <ol style="list-style-type: none"> SCCP/Skinny traffic between the UCC Server and each of the routers. The traffic to the UCC Server will be the number of ephones controlled by the UCC Server multiplied by the bandwidth required for one SCCP session. Voice Media -- RTP (G.711 encoded) 128 Kbps for each call handled by the Mobility Services. The network should have the bandwidth and latency for the peak or maximum number of calls that can handled by the Mobility Service. Radius Messages -- UDP traffic from each router to the UCC Server. <p>Note: The network should also allow the transport of UDP traffic between the routers and the UCC Server.</p>
Location of Routers	<p>Generally the UCC Server should hosted with the largest CME router in a multiple router configuration. The UCC Services are not sensitive to the location of the routers, although it is assumed that the routers are in one country.</p>
Resources Required on each router for the Mobility Services	<p>The Mobility Service requires the following to be configured on each router:</p> <ol style="list-style-type: none"> Mobility-ephones and ephone-DNs. The Mobility Service requires available mobility-ephone in the router of the SNR user's ephone for processing the SNR calls. If the ephones are not available, then the service is not launched. Conferencing resources – since the mobility-ephones are from each router and these ephones request the conferencing services, the conferencing and DSP resources have to be configured on each CNE router from which the users will be using the Single Number Reach service. CUE and Voicemail boxes – the user's calls are returned to the user's voice mailbox. Each router is required to have CUE installed, together with the Transfer-to-Voice Mailbox script and a distinct pilot number to that router's transfer-to-voice mailbox script. Since the Mobility Service utilizes the resources of each router, the CME features of shared DNS, Pickup, Transfer and Conference need to be configured on each router for use by the mobility service.

Dialing Plans and Dialing Rules	The UCC Server allows administrators to setup the location, extension number lengths, outside access codes for each router. The UCC Server also provides per router a digit manipulation table for pre-processing the telephone numbers for dialing and lookup.
---------------------------------	---

Configuring Mobility Ephones/Ephone pools

The UCC Mobility Service uses CME ephones to make and receive calls to provide the Single Number Reach and Dial-In Access services.

These ephones have to be configured in the Cisco CME for each of the routers connected to the UCC Mobility Service. The mobility ephones have a specific configuration requirement as described below:

Mobility Ephone Attributes

Configuration	Description
Ephone MAC Address Example: AAAA.BBBB.1000	This 'Virtual MAC Address' is used as an identifier for the ephone. This should be unique for the UCC System and is required to be unique for each router. (Since there are multiple mobility-ephones configured for each router, you cannot use the network adapter MAC address. In addition the CME requires this to follow the MAC address format, but does not require this to be a physical MAC address.)
Ephone Type 7960	Default phone type for the Mobility-ephones
Ephone DNs	Three single line DN, that are not shared, for each mobility ephone.
Conference Control	Keep Conference – so that when the when the Mobility Service drops out the call is maintained
Feature Set	Standard ephone feature set with pickup, conference, transfer etc.
Codec	G711 codec

Ephone Pools

Ephone Pools are a group of mobility-ephones that are allocated or dedicated to a single mobility application or shared among multiple mobility applications. In multi-router configurations, these ephones must be configured on each router.

General Ephone Pools are a set of ephones that are acquired and released dynamically by a number of mobility applications. A dedicated ephone pool is one where the ephones in that pool or group which belong to and are only used by one mobility applications.

A mobility application can be configured with multiple pools. The application will first try to locate ephones in the dedicated pool, if none are available it will try the general pool.

Number of Ephones for Mobility Services

The following model can be used to calculate the number of mobility ephones on the CME. This is TBD.

CME/UC500 Size	Max SNR Sessions	DISA Ephones	SNR Ephones

Table showing System Size, Max SNR Sessions, DISA and SNR Ephones

CME CONFIGURATION FOR MOBILITY SERVICES

Setting up a Mobility-ephone

you would need to configure an ephone to have one or more shared-DN. Please follow the steps below:

- Step 1.** Click Start -> Run
- Step 2.** Type **telnet xxx.xxx.xxx.xxx** (xxx.xxx.xxx.xxx would be your CME router IP address)
- Step 3.** Enter the username and password
- Step 4.** Enter **config t**
- Step 5.** Type **ephone x** (x would be the ephone id)
- Step 6.** Type **mac-address AAAA.BBBB.1000**
- Step 7.** Type **type 7960**
- Step 8.** Type **keep conference**
- Step 9.** Type **username ucceph1 password cisco**
- Step 10.** Type **button 1:a 2:b 3:c**
 - a, b and c are single-line ephone DNs created for the mobility service.
- Step 11.** Type **exit** when finished

Example of mobility-ephone

Extract from 'Show run'

```
ephone 28
username "38user28" password cisco
mac-address AAAA.BBBB.4307
type 7960
button 1:648 2:649 3:650
keep-conference
```

Extract from 'Show ephone'

```
ephone-28 Mac:AAAA.BBBB.4307 TCP socket:[124] activeLine:0 REGISTERED in SCCP ver 3 and Server in ver 3
mediaActive:0 offhook:0 ringing:0 reset:0 reset_sent:0 paging 0 debug:0 caps:3
IP:192.168.1.14 1889 Telecaster 7960 Telstrat keepalive 132 max_line 16
button 1: dn 648 number 4648 CH1 IDLE
button 2: dn 649 number 4649 CH1 IDLE
button 3: dn 650 number 4650 CH1 IDLE
Username: 38user28 Password: cisco
```

Setup an ePhone with Share-Call Appearance:

The shared call appearance on the mobility-ephones are used to support the option to pickup the SNR call from the user's ephone by pressing the line button. The user's primary ephone-DN needs to be configured on the shared mobility-ephone. When a call arrives at the user's ephone, it will also ring at the shared mobility-ephone. If the rule conditions are met, then the Single Number

Reach service will use this shared mobility-ephone to answer the call and try to locate the user at the specified numbers.

The configuration for the shared appearance mobility-ephone is similar to the mobility-ephone except that you configure an additional button with the the user's primary ephone-DN. Please follow the steps below:

- Step 1.** Click Start -> Run
- Step 2.** Type **telnet xxx.xxx.xxx.xxx** (xxx.xxx.xxx.xxx would be your CME router IP address)
- Step 3.** Enter the username and password
- Step 4.** Enter **config t**
- Step 5.** Type **ephone x** (x would be the ephone id)
- Step 6.** Type **mac-address AAAA.BBBB.1000**
- Step 7.** Type **type 7960**
- Step 8.** Type **keep conference**
- Step 9.** Type **username ucceph1 password cisco**
- Step 10.** Type **button 1:a 2:b 3:c**
a, b and c are single-line ephone DNs created for the mobility service.
- Step 11.** Type **button 4:X** where X is the user's primary DN
- Step 12.** Type **exit** when finished

Setting Up the Radius Accounting

The Cisco CME and its underlying IOS platform can be setup to generate accounting packets for the calls being handled within the system. These accounting messages can provide information on the start-time and end-time of the calls as well as the caller/called numbers. The accounting messages are sent to RADIUS servers using a standard protocol.

The Unified CallConnector Presence Server has an integrated RADIUS server interface to connect with and receive these Radius accounting messages from the Cisco CME systems.

Note: The Cisco CME router has to be configured to enable the voice Radius accounting packets to be sent to the Unified CallConnector. The Unified CallConnector Server acts as the Radius Server and the Cisco CME router is the Radius client that generates and transmits the radius packets.

Cisco RADIUS VSA Voice Implementation Guide provides more details on the Radius setup options. The configuration of the Radius parameters on the router for providing telephone status information to the Presence Server includes the following steps.

In multiple router configurations, each router must be configured to send the RADIUS accounting packets to the UCC Server. Note – the authentication password and the account port are required to the same on each router.

Radius Parameters

- Step 1.** Enabling AAA accounting
- Step 2.** Enabling Connection-based Accounting
- Step 3.** Setting up the Radius Server IP address and port
- Step 4.** Entering the Authentication Key or password
- Step 5.** Enabling the Cisco Accounting Attributes – Vendor Specific Attributes
- Step 6.** Enable accounting for the gateways

Radius Configuration Notes

Item	Description
Accounting Port 1646	This is the port on the UCC Server to which the RADIUS messages are sent by the CME. The port value is set in the CME and must be the same on the UCC Presence Server – Radius Server Parameters page. In multiple router configurations, all accounting ports to the UCC Server must be the same. Note: Verify that the port is available on the UCC Server.
Authentication Key (Password)	The value of the Authentication Key is set in the CME router. This same value must be configured on the UCC Presence Server. In multiple router configurations, the Authentication Key must be the same on all routers.

To Setup Radius Parameters on CME Router

The table below displays the commands for setting up the Radius parameters on the CME router using the Command Line Interface.

Command	Description
enable Router> enable	Enter Exec mode
Configure terminal Router # configure term	Enter global configuration mode
aaa new-model Router (config)# aaa new-model	Enables AAA
aaa accounting connection h323 start-stop radius Router (config)# aaa accounting connection h323 start-stop broadcast group uccserver	Enables connection based accounting and send stop and start packets
aaa group server radius uccserver server 192.168.1.18 auth-port 1645 acct-port 1646 Router (config)# aaa group server radius uccserver	Specifies the IP address and ports for the servers that are in the group uccserver above
aaa accounting update newinfo Router (config)# aaa accounting update newinfo	Enables sending update packets for new information
radius-server host Router (config)# radius-server host 1.1.1.1 auth-port 1645 acct-port 1646	Specifies the Radius Server IP-Address and accounting port. The IP Address and Port should match the setting on the Presence Server Radius configuration.
radius-server key Router (config)# radius-server key password cisco	Sets the password for authenticating the Radius server. This password should also be entered in the Radius configuration on the Server Wizard Radius Window,
radius-server vsa send accounting Router (config)# radius-server vsa send accounting	Sends vendor specific attributes.
aaa session-id common Router (config)# aaa session-id common	Set common session id
gw-accounting syslog gw-accounting aaa Router (config)# gw-accounting aaa	Enable accounting for gateway endpoints

Below is an example of the router configuration file showing the Radius parameter settings.

```

aaa new-model
aaa group server radius uccserver
  server 192.168.1.116 auth-port 1645 acct-port 1646
aaa accounting update newinfo
aaa accounting connection h323 start-stop broadcast group uccserver
aaa session-id common
gw-accounting syslog
gw-accounting aaa
radius-server host 192.168.1.116 auth-port 1645 acct-port 1646 key
uccserver
radius-server vsa send accounting
radius-server vsa send authentication

```

Verifying Radius Settings

- Step 1.** Use the 'Show Running Config' from the CLI to verify your router settings.
- Step 2.** Verify that each router is sending the accounting messages to the UCC Server IP Address. Use the Debug Radius Accounting
- Step 3.** Once the UCC Server has been setup, you can verify using the 'View Radius Message' utility to view the messages being received from the routers.
- Step 4.** Verify that the Radius parameters have been setup correctly on all the routers.

Example of Radius Accounting Debug Messages

Note: The Send Accounting Request to IP-Address and the corresponding response indicating receipt and acknowledgement from UCC Server.

```

26 20:19:56.442: RADIUS(000549E7): Send Accounting-Request to 192.168.1.99:1646 id 1646/138, len 867
26 20:19:56.442: RADIUS: authenticator 58 A6 38 48 9F 73 B4 92 - 44 05 5E 12 37 B5 8F A1
26 20:19:56.442: RADIUS: Acct-Session-Id [44] 10 "000A92A9"
26 20:19:56.442: RADIUS: Calling-Station-Id [31] 6 "4002"
26 20:19:56.442: RADIUS: Vendor, Cisco [26] 61
26 20:19:56.442: RADIUS: h323-setup-time [25] 55 "h323-setup-time=*12:19:54.786 central Wed Dec 26 2007"
26 20:19:56.442: RADIUS: Vendor, Cisco [26] 40
26 20:19:56.442: RADIUS: h323-gw-id [33] 34 "h323-gw-id=cc3845.yourdomain.com"
26 20:19:56.442: RADIUS: Vendor, Cisco [26] 56
26 20:19:56.442: RADIUS: Conf-Id [24] 50 "h323-conf-id=C1535895 B32611DC B4D0D9D2 5FE6F9B4"
26 20:19:56.442: RADIUS: Vendor, Cisco [26] 31
26 20:19:56.442: RADIUS: h323-call-origin [26] 25 "h323-call-origin=answer"
26 20:19:56.442: RADIUS: Vendor, Cisco [26] 32
26 20:19:56.442: RADIUS: h323-call-type [27] 26 "h323-call-type=Telephony"
26 20:19:56.442: RADIUS: Vendor, Cisco [26] 65
26 20:19:56.442: RADIUS: Cisco AVpair [1] 59 "h323-incoming-conf-id=C1535895 B32611DC B4D0D9D2
5FE6F9B4"
26 20:19:56.442: RADIUS: Vendor, Cisco [26] 30
26 20:19:56.442: RADIUS: Cisco AVpair [1] 24 "subscriber=RegularLine"
26 20:19:56.442: RADIUS: Vendor, Cisco [26] 134
26 20:19:56.442: RADIUS: Cisco AVpair [1] 128 "feature-vsa=fn:TWC,ft:12/26/2007 12:19:54.786,cgn:4002,cdn
frs:0,fid:471652,fcid:C1535895B32611DCB4D0D9D25FE6F9B4,legID:58BBB"
26 20:19:56.442: RADIUS: Acct-Input-Octets [42] 6 0

```

```

26 20:19:56.442: RADIUS: Acct-Output-Octets [43] 6 0
26 20:19:56.442: RADIUS: Acct-Input-Packets [47] 6 0
26 20:19:56.442: RADIUS: Acct-Output-Packets [48] 6 0
26 20:19:56.442: RADIUS: Acct-Session-Time [46] 6 0
26 20:19:56.442: RADIUS: Vendor, Cisco [26] 63
26 20:19:56.442: RADIUS: h323-connect-time [28] 57 "h323-connect-time=*12:19:56.434 central Wed Dec 26 2007"
26 20:19:56.442: RADIUS: Vendor, Cisco [26] 66
26 20:19:56.442: RADIUS: h323-disconnect-tim[29] 60 "h323-disconnect-time=*12:19:56.434 central Wed Dec 26 2007"
26 20:19:56.442: RADIUS: Vendor, Cisco [26] 32
26 20:19:56.442: RADIUS: h323-disconnect-cau[30] 26 "h323-disconnect-cause=10"
26 20:19:56.442: RADIUS: Vendor, Cisco [26] 35
26 20:19:56.442: RADIUS: Cisco AVpair [1] 29 "h323-ivr-out=Tariff:Unknown"
26 20:19:56.442: RADIUS: Vendor, Cisco [26] 24
26 20:19:56.442: RADIUS: Cisco AVpair [1] 18 "release-source=1"
26 20:19:56.442: RADIUS: Vendor, Cisco [26] 28
26 20:19:56.442: RADIUS: h323-voice-quality [31] 22 "h323-voice-quality=0"
26 20:19:56.442: RADIUS: Vendor, Cisco [26] 47
26 20:19:56.442: RADIUS: Cisco AVpair [1] 41 "gw-rxd-cgn=ton:0,np:0,pi:0,si:0,#:4002"
26 20:19:56.442: RADIUS: User-Name [1] 6 "4002"
26 20:19:56.442: RADIUS: Acct-Status-Type [40] 6 Stop [2]
26 20:19:56.442: RADIUS: NAS-Port-Type [61] 6 Virtual [5]
26 20:19:56.442: RADIUS: NAS-Port [5] 6 60000
26 20:19:56.442: RADIUS: NAS-Port-Id [87] 15 "EFXS 50/0/358"
26 20:19:56.442: RADIUS: Service-Type [6] 6 Login [1]
26 20:19:56.442: RADIUS: NAS-IP-Address [4] 6 192.168.1.122
26 20:19:56.442: RADIUS: Acct-Delay-Time [41] 6 0
26 20:19:56.442: RADIUS: Received from id 1646/135 192.168.1.99:1646, Accounting-response, len 20
26 20:19:56.442: RADIUS: authenticator B5 42 1C 4B 5B 29 6E CB - 79 F5 3E 83 56 D1 94 2C
26 20:19:56.442: RADIUS: Received from id 1646/136 192.168.1.14:1646, Accounting-response, len 20
26 20:19:56.442: RADIUS: authenticator BE 4D 8E 20 BB ED A2 E9 - 91 6A 0C FE 9B 74 34 02

```

3845#

Setup on Conferencing:

Prerequisites

- Cisco Unified CME 4.1 or a later version
- You must have a PVDM2-8, PVDM2-16, PVDM2-32, or PVDM2-64 high-density packet voice digital signal processor module hosted on the motherboard or on a module such as the NM-HDV2 or NM-HD-2VE.
- For Cisco Unified IP Phone 7985, firmware version 4-1-2-0 or a later version

Restrictions

- The maximum number of meet-me conference parties is 32 for one DSP using the G.711 codec and 16 for the G.729 codec.
- A participant cannot join more than one conference at the same time.
- Ad hoc conferencing for more than three parties (hardware-based) is not supported on the Cisco Unified IP Phone 7906 and 7910 and Cisco Unified IP Phone 7914 Expansion Module.
- Ad hoc conferencing for more than three parties is not supported on Cisco Unified IP phones running SIP.
- Hardware-based ad hoc conferencing does not support the local-consult transfer method (transfer-system local-consult command).

Enabling DSP Farm Services for a Voice Card

To enable DSP farm services for a voice card to support multi-party ad hoc and meet-me conferences, perform the following steps. For detailed steps for configuring CME conferencing, see Appendix B.

Summary Steps

- Step 1.** enable
- Step 2.** configure terminal
- Step 3.** voice-card *slot*
- Step 4.** dsp services dspfarm
- Step 5.** exit

Configuring Join and Leave Tones

To configure tones to be played when parties join and leave ad hoc and meet-me conferences, perform the following steps for each tone to be configured.

Summary Steps

- Step 1.** enable
- Step 2.** configure terminal
- Step 3.** voice class custom-cptone *cptone-name*
- Step 4.** dualtone conference

- Step 5.** frequency *frequency-1* [*frequency-2*]
- Step 6.** cadence {*cycle-1-on-time cycle-1-off-time* [*cycle-2-on-time cycle-2-off-time*] [*cycle-3-on-time cycle-3-off-time*] [*cycle-4-on-time cycle-4-off-time*]} | continuous
- Step 7.** end

Configuring SCCP for Cisco Unified CME

To enable Skinny Client Control Protocol (SCCP) on Cisco Unified CME, perform the following steps:

Summary Steps

- Step 1.** enable
- Step 2.** configure terminal
- Step 3.** sccp local *interface-type interface-number* [port *port-number*]
- Step 4.** sccp ccm {*ip-address* | *dns*} identifier *identifier-number* [priority *priority*] [port *port-number*] [version *version-number*]
- Step 5.** sccp ccm group *group-number*
- Step 6.** bind interface *interface-type interface-number*
- Step 7.** exit
- Step 8.** sccp
- Step 9.** exit

Configuring the DSP Farm

To configure the DSP farm profile for multi-party ad hoc and meet-me conferencing, perform the following steps.

Note: The DSP farm can be on the same router as the Cisco Unified CME or on a different router.

Summary Steps

- Step 1.** enable
- Step 2.** configure terminal
- Step 3.** dspfarm profile *profile-identifier* conference
- Step 4.** codec {*codec-type* | pass-through}
- Step 5.** conference-join custom-cptone *cptone-name*
- Step 6.** conference-leave custom-cptone *cptone-name*
- Step 7.** maximum conference-party *max-parties*
- Step 8.** maximum sessions *number*
- Step 9.** associate application sccp
- Step 10.** end

Associating Cisco Unified CME with a DSP Farm Profile

To associate a DSP farm profile with a group of Cisco Unified CME routers that control DSP services, perform the following steps.

Summary Steps

- Step 1.** enable
- Step 2.** configure terminal
- Step 3.** sccp ccm group *group-number*
- Step 4.** associate ccm *identifier-number* priority *priority-number*
- Step 5.** associate profile *profile-identifier* register *device-name*
- Step 6.** end

Enabling Multi-Party Ad Hoc and Meet-Me Conferencing

To allow multi-party ad hoc conferences with more than three parties and meet-me conferences, perform the following steps.

Note: Configuring multi-party ad hoc conferencing in Cisco Unified CME disables three-party ad hoc conferencing.

Summary Steps

- Step 1.** enable
- Step 2.** configure terminal
- Step 3.** telephony-service
- Step 4.** conference hardware
- Step 5.** sdsfarm units *number*
- Step 6.** sdsfarm tag *number device-name*
- Step 7.** sdsfarm conference mute-on *mute-on-digits* mute-off *mute-off-digits*
- Step 8.** end

Configuring Multi-Party Ad Hoc Conferencing and Meet-Me Numbers

To configure numbers for multi-party ad hoc and meet-me ad hoc conferencing, based on the maximum number of conference participants you configure, perform the following steps. Ad hoc conferences require four extensions per conference, regardless of how many extensions are actually used by the conference parties.

Note: Ensure that you configure enough directory numbers to accommodate the anticipated number of conferences. The maximum number of parties in a multi-party ad hoc conference on an IP phone is eight; the maximum on an analog phone is three.

Summary Steps

- Step 1.** enable
- Step 2.** configure terminal
- Step 3.** ephone-dn *dn-tag* [dual-line]
- Step 4.** number *number* [secondary *number*] [no-reg [both | primary]]
- Step 5.** conference {ad-hoc | meetme}
- Step 6.** preference *preference-order* [secondary *secondary-order*]
- Step 7.** no huntstop [channel]
- Step 8.** end

Configuring Conferencing Options for a Phone

To configure a template of conferencing features such as the add party mode, drop party mode, and soft keys, for multi-party ad hoc, and meet-me conferences and apply the template to a phone, perform the following steps.

Note: The following commands can also be configured in ephone configuration mode. Commands configured in ephone configuration mode have priority over commands in ephone-template configuration mode.

Restrictions

The ConfList (including the Remove, Update, and Exit soft keys within the ConfList function) and RmLstC soft keys do not work on a Cisco Unified IP Phone 7902, 7935, and 7936.

Summary Steps

- Step 1.** enable
- Step 2.** configure terminal
- Step 3.** ephone-template *template-tag*
- Step 4.** conference add-mode [creator]
- Step 5.** onference drop-mode [creator | local]
- Step 6.** conference admin
- Step 7.** softkeys connected [Acct] [ConfList] [Confrn] [Endcall] [Flash] [HLog] [Hold] [Join] [Park] [RmLstC] [Select] [Trnsfer]
- Step 8.** softkeys hold [Join] [Newcall] [Resume] [Select]
- Step 9.** softkeys idle [Cfwdall] [ConfList] [Dnd] [Gpickup] [HLog] [Join] [Login] [Newcall] [Pickup] [Redial] [RmLstC]
- Step 10.** softkeys seized [CallBack] [Cfwdall] [Endcall] [Gpickup] [HLog] [MeetMe] [Pickup] [Redial]
- Step 11.** exit
- Step 12.** ephone *phone-tag*
- Step 13.** ephone-template *template-tag*
- Step 14.** end

Setup Direct Transfer to Voicemail

Introduction

This section provides a sample configuration for enabling direct transfer to CUE/Voicemail of a user by dialing a speed-dial code. It details how a speed-dial can be created to setup a call to a CUE AA and then send digits for identifying a voicemail mailbox.

The sample demonstrates the ease with which Cisco CallManager Express can integrate with Cisco Unity Express to offer fast access to a user's voicemail instead of going through ringback and then hearing a user's voicemail prompt. This configuration would be especially useful when a receptionist monitors phones and knows that the phone is busy and needs to transfer the caller directly to voicemail.

Dial plan

Before configuring CME and CUE, you should plan your dial plan for CME IP phones, CUE and bulk speed-dial on CME. The following is a sample of numbers that need to be defined before configuring the system.

Name	Number	Description
IP Phones (with Voicemail)	1001, 1002, 1003	Ephone-dn numbers of IP phones that have a voicemail mailbox.
Bulk speed-dial prefix	#	Bulk speed-dial prefix is used to access bulk speed-dial numbers. # is default but this can be changed to * or #/* followed by other numbers.
Bulk speed-dial file for direct access to VM	0	This is the reference to a file that contains entries for bulk speed-dial codes. This is used in conjunction with bulk speed-dial prefix and list entry to address a particular number
Bulk speed-dial entries	1,2,3	Each speed-dial is referred to by an entry. This is used in conjunction with bulk speed-dial prefix and file reference to refer to a particular number. In this example, 1 would refer to 1001, 2 to 1002, 3 to 1003.
CUE AA pilot for direct transfer to VM script	6500	Trigger on CUE for direct transfer to VM script.

To Setup the Transfer-to-Voicemail Script

Step 1. Open the Cisco Unity Express (CUE) administration page. In this example go to the web page: <http://192.168.1.123/>

Step 2. Login as the administrator:

Username: admin

Password: admin

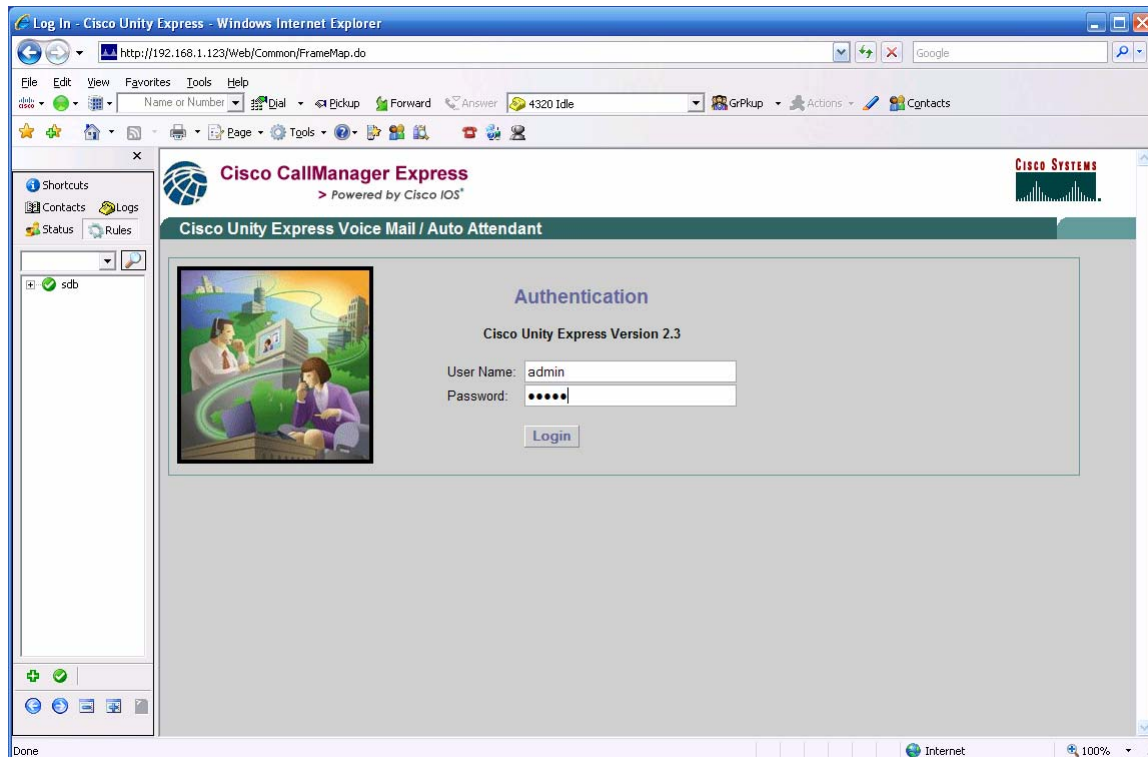

Step 3. From the Voice Mail menu, select Auto Attendant. The Auto-Attendant pages will display.

Step 4. Click on the Add button to add the DirectTransfertoVoiceMail script. To update or make changes, you can click on the script name.

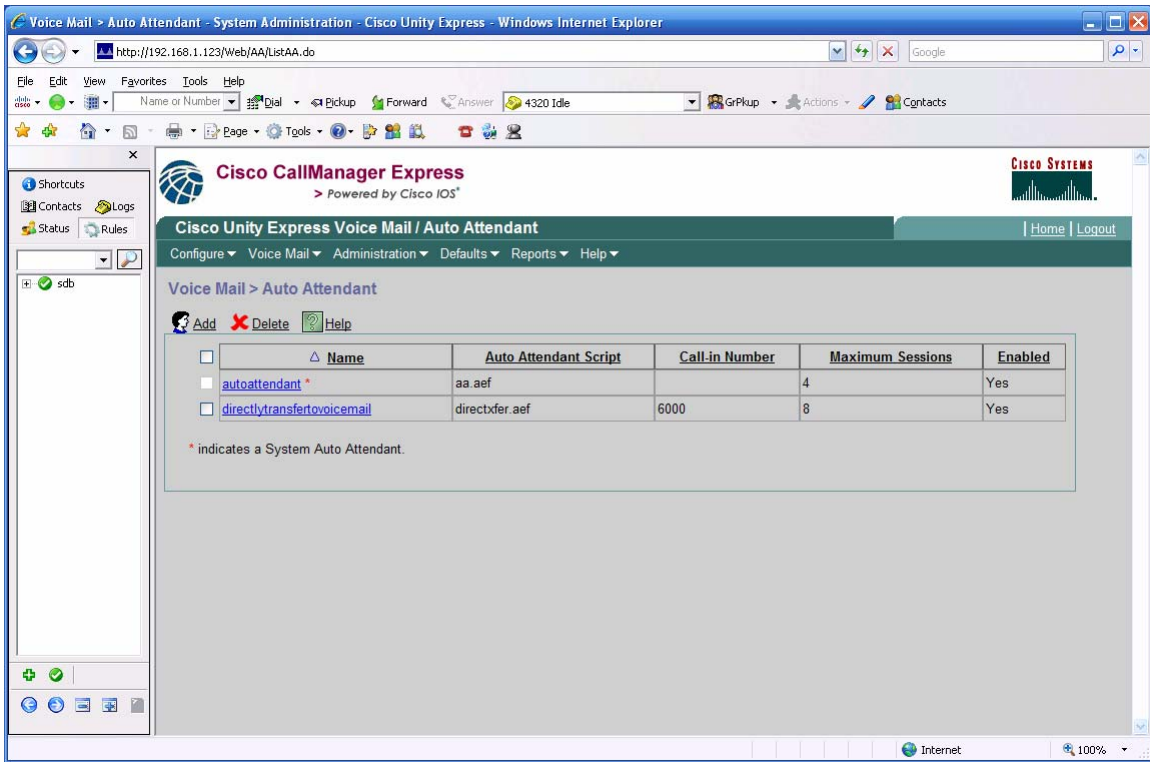
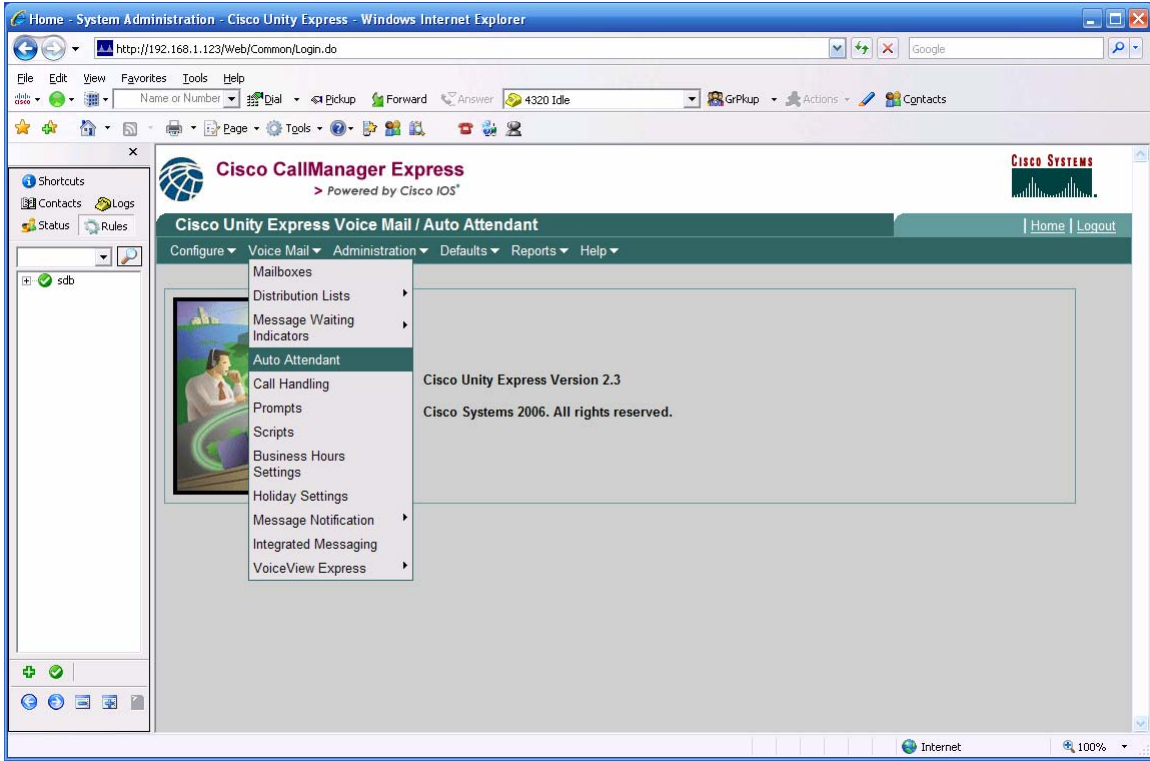

Step 5. Click on the directlytransfertovoicemail

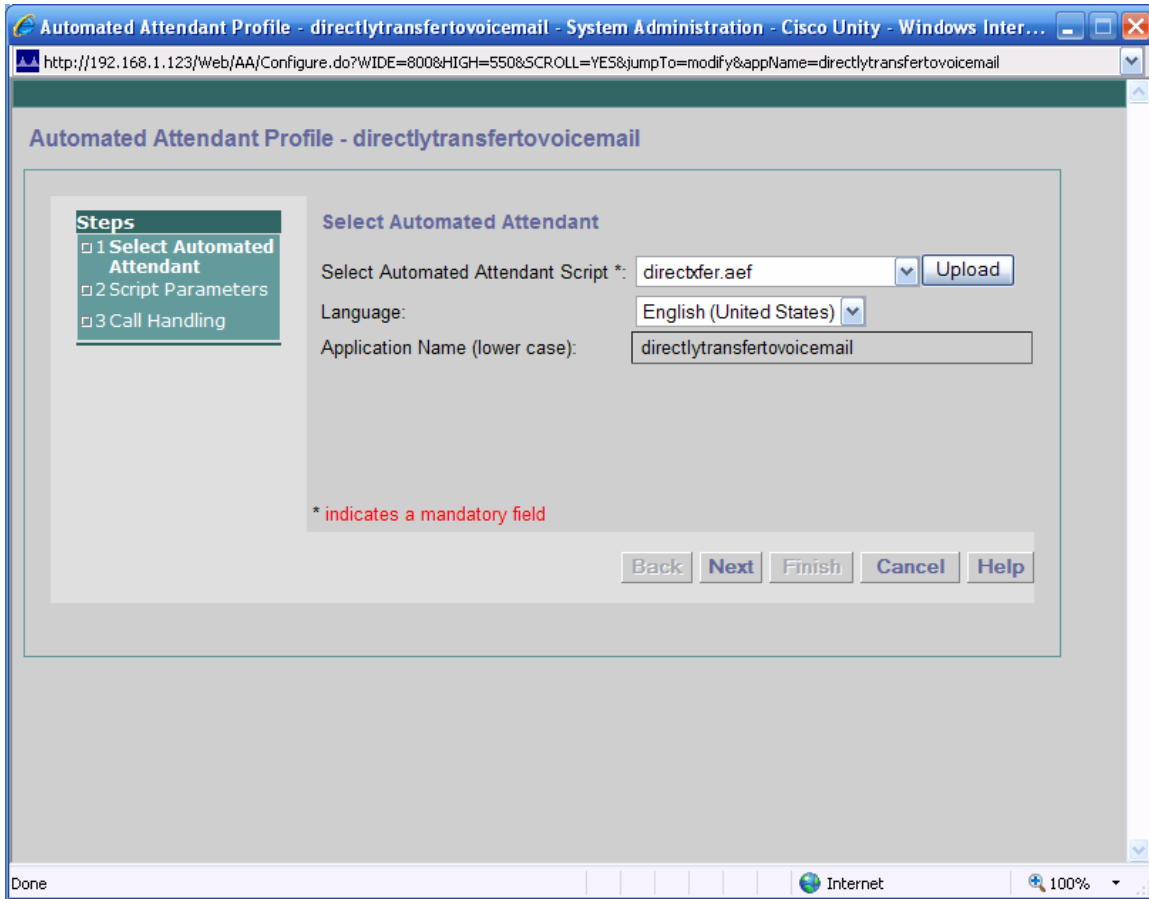

Step 6. Click upload the new script, browse to select the script file and click on upload.

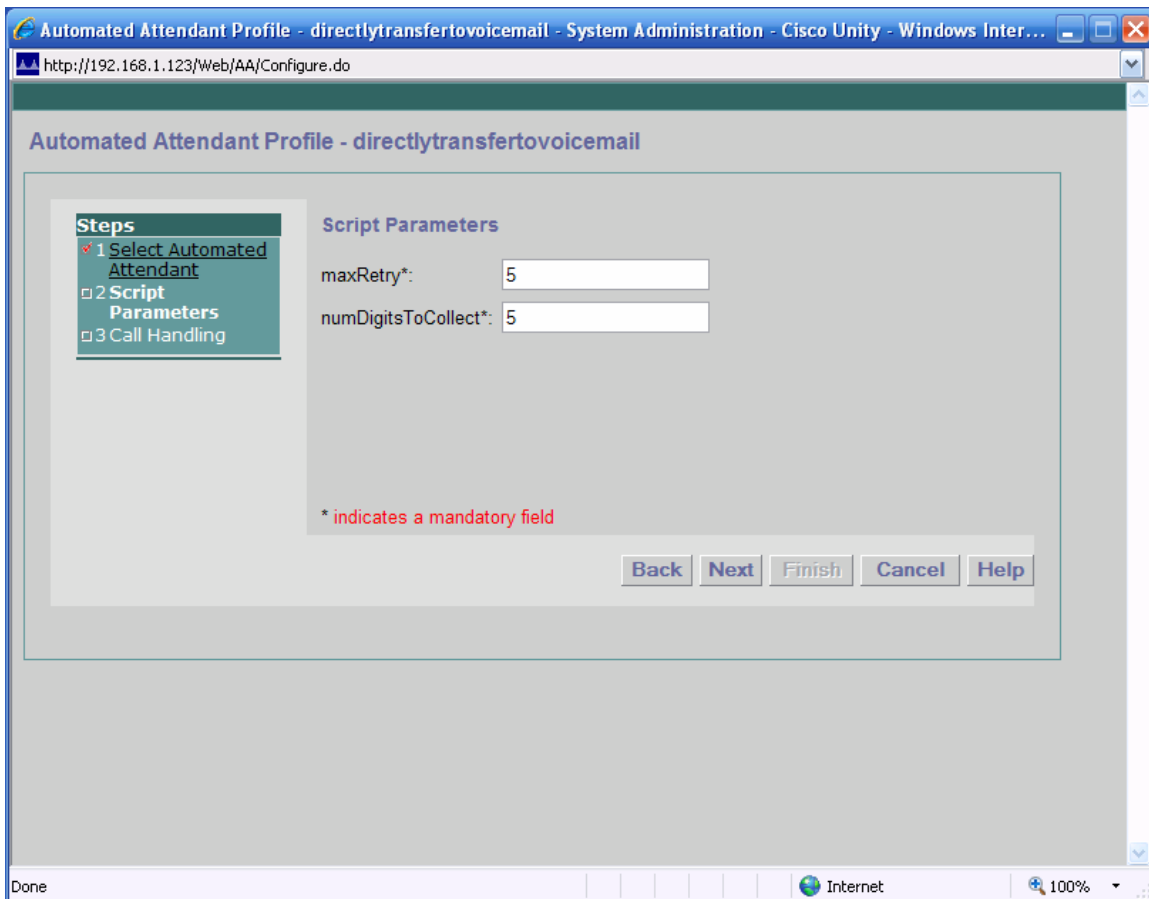
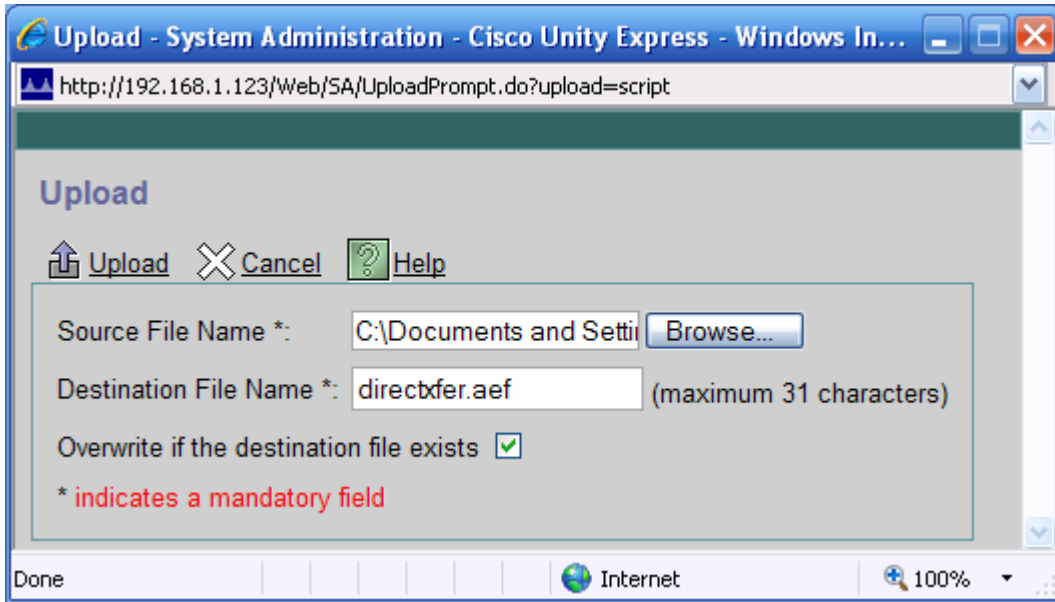

Step 7. Set the number of digits in the extension. Note CUE will timeout and drop the call after the max re-tries.

Step 8. Note: Call-in number must be the same as the directory number (DN) on the route point in this case, 6000

```
dial-peer voice 10 voip
destination-pattern 6...
session protocol sipv2
session target ipv4:192.168.1.123
dtmf-relay sip-notify
codec g711ulaw
no vad
```

Setup Hunt Group for DISA calls:

Setup a hunt group to provide a pilot number for the Dial-In Access calls. perform the following steps.

Hunt Group Configuration

Directory numbers to be included in a hunt group must be already configured in Cisco Unified CME.

Summary Steps

- Step 1.** enable
- Step 2.** configure terminal
- Step 3.** ephone-hunt *hunt-tag* {longest-idle | peer | sequential}
- Step 4.** pilot *number* [secondary *number*]
- Step 5.** list *number* [, *number*...]
- Step 6.** exit
- Step 7.** end

DETAILED STEPS

	Command or Action	Purpose
Step 1	enable Example: Router> enable	Enables privileged EXEC mode. <ul style="list-style-type: none"> • Enter your password if prompted.
Step 2	configure terminal Example: Router# configure terminal	Enters global configuration mode.
Step 3	ephone-hunt <i>hunt-tag</i> {longest-idle peer sequential} Example: Router(config)# ephone-hunt 23 sequential	Enters ephone-hunt configuration mode to define an ephone hunt group. <ul style="list-style-type: none"> • <i>hunt-tag</i>—Unique sequence number that identifies this hunt group during configuration tasks. Range: 1 to 100. • sequential—Ephone-dns ring in the left-to-right order in which they are listed when the hunt group is defined.
Step 4	pilot <i>number</i> [secondary <i>number</i>]	Defines the pilot number, which is the number that callers dial to reach the hunt group. <ul style="list-style-type: none"> • <i>number</i>—E.164 number up to 27 characters.

	Example: Router(config-ephone-hunt)# pilot 4085551212	This is the number user's will dial to access the DISA services.
Step 5	list <i>number</i> [, <i>number</i> ...] Example: Router(config-ephone-hunt)# list 5001, 5002, 5017, 5028	Defines the list of numbers (from 2 and 20) to which the ephone hunt group redirects the incoming calls. <ul style="list-style-type: none"> <i>number</i>—E.164 number up to 27 characters. Number assigned to the primary ephone-dn (number of the first button) on each of the mobility-ephones setup for the Dial-In Access service.
Step 26	end Example: Router(config-ephone-dn)# end	Returns to privileged EXEC mode.

Verifying Hunt Groups

Use the **show running-config** command to verify your configuration. Ephone hunt group parameters are listed in the ephone-hunt portion of the output.

Router# **show running-config**

```

!
ephone-hunt 2 sequential
pilot 4085551212
list 621, *, 623
!
```

Use the **show ephone-hunt** command for detailed information about hunt groups, including dial-peer tag numbers, hunt-group agent status, and on-hook time stamps. This command also displays the dial-peer tag numbers of all ephone-dns that have joined dynamically and are members of the group at the time that the command is run.

Router# **show ephone-hunt**

```

Group 2
type: sequential
pilot number: 4085551212, peer-tag 20098
list of numbers:
123, aux-number A601A0200, # peers 1, logout 0, down 0
peer-tag dn-tag rna login/logout up/down
[20097 56 0 login up ]
622, aux-number A601A0201, # peers 3, logout 0, down 0
peer-tag dn-tag rna login/logout up/down
[20101 112 0 login up ]
[20100 111 0 login up ]
[20099 110 0 login up ]
```

```
623, aux-number A601A0202, # peers 3, logout 0, down 0
peer-tag dn-tag rna login/logout up/down
[20104 122 0 login up ]
[20103 121 0 login up ]
[20102 120 0 login up ]
*, aux-number A601A0203, # peers 1, logout 0, down 1
peer-tag dn-tag rna login/logout up/down
[20105 0 0 - down]
*, aux-number A601A0204, # peers 1, logout 0, down 1
peer-tag dn-tag rna login/logout up/down
[20106 0 0 - down]
```

CONFIGURING UCC MOBILITY SERVICE

Once the Cisco CME has been setup to support the UCC Mobility Services, the CallConnector Server Wizard can be used to configure the Single Number Reach and Dial-In Access services.

The following capabilities need to be configured on the UCC Server to support the Mobility Service:

- The Mobility Service applications need to be installed and registered (activated).
- UCC Presence Server needs to be setup to receive the RADIUS messages and be able to look up numbers in the contact directory.
- For each router, the location, dialing access codes, CUE routing methods have to be setup.
- Dialing translation rules for making calls and looking up numbers has to be setup and verified.
- The Mobility Ephones have to be specified for each router.
- Single Number Reach and Dial-In Access system parameters have to be set.
- Holiday, working days and working hours need to be defined.
- Ephone pools need to be created and allocated to the mobility applications.
- User contact details need to be updated for Voice Mail box, Telephone (Single Number Reach) password and DISA password.

Each of these configuration steps will be covered in more detail in the sections below.

Registering UCC Mobility Service

To provide the SNR, Mid-Call and DISA features, the UCC Server with Mobility Services has to be installed and the Mobility Service has to be registered. (The UCC Server applications are available in two versions a) UCC Server and b) UCC Server with Mobility. The UCC Server provides presence status, instant messaging etc while the UCC Server with Mobility Services incrementally adds the Mobility Applications to the UCC Server. The UCC Server is also required to be installed and licensed).

When the UCC Mobility Service is installed, the Server Wizard displays the Automation/Mobility Server options and enables access to the configuration pages.

To register the Mobility Service you will need the serial number or this optional capability. If you do not have a serial number, you can run in an evaluation mode for 30 days.

To Register UCC Mobility Software

- Step 1.** Start the UCC Server Wizard from Programs ->Cisco Systems->Unified CallConnector Server-> Cisco Unified CallConnector Server Wizard
- Step 2.** Click on Automation/Mobility Server button to go to the Server parameters page.
- Step 3.** Enter the Mobility Server Serial Number or 'trial' and click on the Update button.
- Step 4.** The Registration/Activation window will display. Click on Activate to register the software.
- Step 5.** When the Mobility Server is registered the Server Parameters page will display the serial number.

Notes:

1. The activation process uses the Internet to register the serial number and your server machine information to the UCC License Server. This process requires access to the Internet.
2. The Serial Number can be activated on only one physical machine.
3. Virtual Windows environments such as VMWare are not supported.

Verify Presence RADIUS Server Settings

From the Server Wizard home page, click on the Presence Server button and then Next to open the Presence Server Radius Parameters page.

The screenshot shows the 'Unified CallConnector Server Setup Wizard' window. The title bar includes a checkmark icon and the text 'Presence Server Radius Parameters'. The main content area is titled 'Radius Parameters:' and contains the following fields and controls:

- Authentication Key (Password):** A text box containing a series of asterisks (*****).
- Radius Accounting Port:** A text box containing the value '1646'. To its right is a button labeled 'View Radius Messages'.
- Note:** The RADIUS Accounting service on the router need to be enabled. In addition:
 - Radius-server host ip-address = This PC ip-address
 - Radius-server acct-port = Accounting Port (above)
 - Radius-server key = Authentication Key (above)
- Enable trace log file:** A checked checkbox.
- Trace Level:** A dropdown menu set to '5'.
- Trace File:** A text box containing the path 'C:\Program Files\Cisco Systems\Cisco Unified CallConnector Server\'. Below this text box is a horizontal line.

At the bottom of the window, there is a text prompt: 'Click on Next to continue.' Below this are five buttons: 'Home', 'Help', '< Back', 'Next >', and 'Finish'. The 'Next >' button is highlighted with a dashed border.

To Setup and Verify Radius Settings

- Step 1.** Enter or verify that the Authentication Key is the same value set on the CME router. In multiple router configurations, all routers should have the same password for the UCC Server.
- Step 2.** Enter or verify that the port setting is the same on the router and the UCC Server. This Radius port must be available and not used by any other application or blocked by firewalls.
- Step 3.** You can verify that the Radius messages are being received by clicking on the "View Radius Messages" button. Click on the Connect button. If the connection succeeds, then the port has been successfully opened, otherwise some application or firewall is blocking access. (Note: the Presence Server should be stopped before you can run this application)
- Step 4.** Go off-hook or make calls to the phones on each router, the Radius messages should be displayed in the Radius Test window.

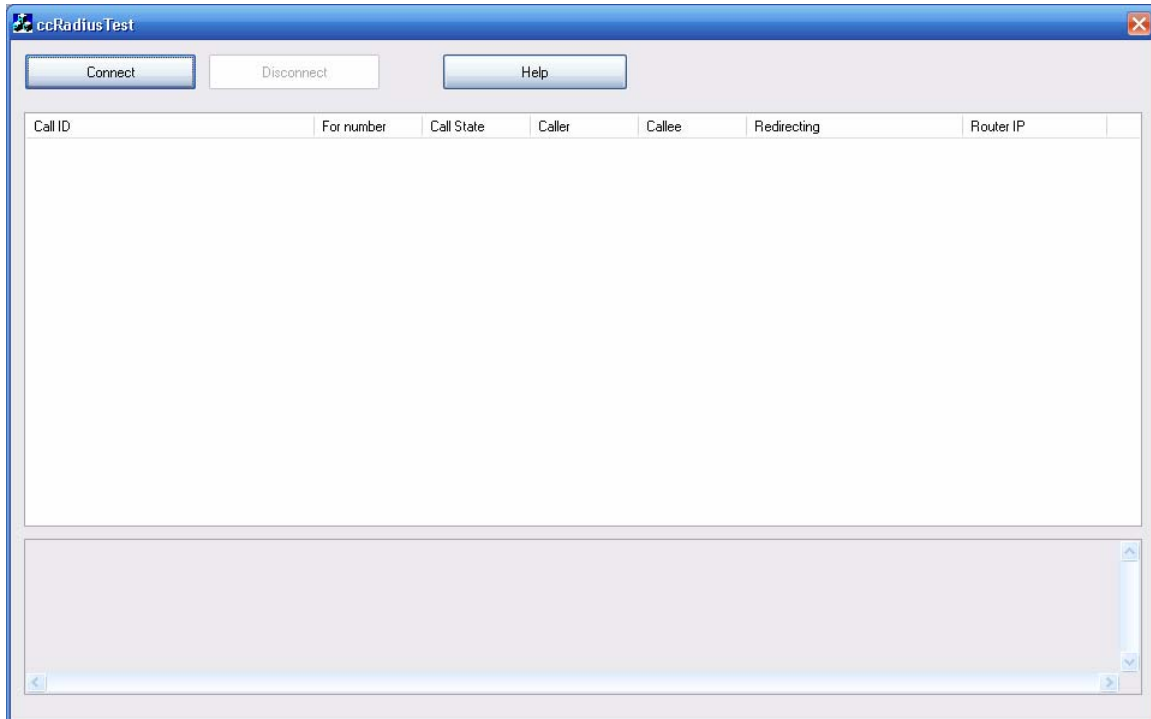

Test Utility to View Radius Messages

Notes:

1. The Presence Server filters out telephone status messages from telephone numbers that are not in the UCC Corporate Directory. Therefore even though you might see the Radius events for a phone number, the telephone status may not display in the Status window. Therefore to receive telephone status events, the following must be properly configured:
 - a. Router must be configured to send Radius messages to the UCC Server
 - b. UCC Server must receive the Radius messages
 - c. The telephone numbers (caller or called) must be in the Corporate Directory
 - d. The UCC Server Dial plan must be properly setup so that the numbers as provided in the Radius messages can be formatted for lookup. This means that after lookup formatting the incoming number will be identical to the 'canonically' formatted number in the directory.
2. The telephone numbers in the UCC directory is saved in the 'canonical' format e.g. (408) 555-1212. The telephone numbers in the Radius message are not formatted. The Presence Server uses the dialing rules to convert the Radius telephone numbers to the canonical format and then searches the Corporate Directory for a match. You will need to verify that the dial plan is correctly configured on the server so that the numbers sent in the Radius messages (as displayed in the 'View Radius Messages' window) are being formatted to allow successful searching.

- The Presence Server and Radius Server log files provide details of the incoming events and the results of the processing. To view this information, set the trace level to 5 and enable logging for these servers. Examples below show sections from the server log files:

RADIUS SERVER LOG EXTRACT

2007-12-21--07:05:22#####Incoming Radius Packet from 192.168.1.122#####

DATE & TIME: Fri Dec 21 07:05:22 2007

Identifier: 92

Attributes:

(44)Acct-Session-ID=000A58F7

(26)Vendor-Specific: (25)h323-setup-time="h323-setup-time=*07:11:21.049 central Fri Dec 21 2007"

(26)Vendor-Specific: (26)h323-call-origin="h323-call-origin=answer"

(26)Vendor-Specific: (1)Cisco AVpair="feature-vsa=fn:TWC,ft:12/21/2007

07:11:21.045,cdn:4225,cdn:frs:0,fid:464275,fcid:D235EC29AF0D11DCA937D9D25FE6F9B4,legID:56EEA"

(40)Acct-Status-Type=1

(5)NAS-Port=60000

(87)NAS-Port-ID=EFXS 50/0/225

(4)NAS-IP-Address=192.168.1.122

2007-12-21--07:05:22<<Radius>> CallInfo event fired for number 4225 with state OffHook.

2007-12-21--07:05:22[SkinnyCallInfo::Dump()] CallRef:13978 Calling:4225 Called: OriginalCalled: LastRedirecting: CallType:1
LastRedirRxn:0 Trunk:0 LineInst:0 ExtCallId:D235EC29AF0D11DCA937D9D25FE6F9B4 RouterIp:192.168.1.122

2007-12-21--07:05:22<<Radius>> Updated 0 call(s). Added 1 call(s). Total call legs: 20.

2007-12-21--07:05:22<<Radius>> Calls cleaned up. Calls:12. Legs:20.

2007-12-21--07:05:22<<Radius>> Call ID Manager entries: 12.

PRESENCE SERVER LOG EXTRACT

<<ccPresenceServer>>[TRACE]@2007-12-28@10:56:10** <0x08A0> [][CRadiusAPI::fire_CallInfo]

<<ccPresenceServer>>[DEBUG]@2007-12-28@10:56:10** <0x08A0> [CRadiusAPI::fire_CallInfo]: ***

CRadiusAPI::fire_CallInfo: CallDirection=0, CallRef=42 ,CallingParty=902112345678, CalledParty=919493991085, CallState=5, RedirectedReason=0

<<ccPresenceServer>>[DEBUG]@2007-12-28@10:56:10** <0x08A0> [CRadiusAPI::fire_CallInfo]: CONNECTED

<<ccPresenceServer>>[TRACE]@2007-12-28@10:56:10** <0x08A0> [][GetCurrentDateTime]

<<ccPresenceServer>>[TRACE]@2007-12-28@10:56:10** <0x08A0> [][GetCurrentDateTime]

<<ccPresenceServer>>[DEBUG]@2007-12-28@10:56:10** <0x08A0> [CRadiusAPI::fire_CallInfo]: ### Call '42' found and being updated

<<ccPresenceServer>>[TRACE]@2007-12-28@10:56:10** <0x08A0> [CCallInfo::dump]: *-----

<<ccPresenceServer>>[TRACE]@2007-12-28@10:56:10** <0x08A0> [CCallInfo::dump]: * Router : 192.168.1.122

<<ccPresenceServer>>[TRACE]@2007-12-28@10:56:10** <0x08A0> [CCallInfo::dump]: * Call Ref : (42)

<<ccPresenceServer>>[TRACE]@2007-12-28@10:56:10** <0x08A0> [CCallInfo::dump]: * Local Number : +902112345678

<<ccPresenceServer>>[TRACE]@2007-12-28@10:56:10** <0x08A0> [CCallInfo::dump]: * Other Party Number : 9493991085

<<ccPresenceServer>>[TRACE]@2007-12-28@10:56:10** <0x08A0> [CCallInfo::dump]: * Ring Duration : 3813

<<ccPresenceServer>>[TRACE]@2007-12-28@10:56:10** <0x08A0> [CCallInfo::dump]: * Connect Duration : 0

<<ccPresenceServer>>[TRACE]@2007-12-28@10:56:10** <0x08A0> [CCallInfo::dump]: * Direction : Out

<<ccPresenceServer>>[TRACE]@2007-12-28@10:56:10** <0x08A0> [CCallInfo::dump]: * Status : Completed

<<ccPresenceServer>>[TRACE]@2007-12-28@10:56:10** <0x08A0> [CCallInfo::dump]: *-----

<<ccPresenceServer>>[DEBUG]@2007-12-28@10:56:10** <0x08A0> [CRadiusAPI::fire_CallInfo]: *** CRadiusAPI::fire_CallInfo:

CallDirection=1, CallRef=42 ,CallingParty=902112345678, CalledParty=919493991085, CallState=5, RedirectedReason=0

<<ccPresenceServer>>[TRACE]@2007-12-28@10:56:10** <0x08B0> [][CSVRTTransactions::PublishCallInfo]

<<ccPresenceServer>>[ERROR]@2007-12-28@10:56:10** <0x08B0> [CSVRTTransactions::PublishCallInfo]: *** LOCAL NUMBER NOT FOUND (+902112345678)

Router Location and Feature Settings

The UCC Server supports multiple Cisco routers. These routers may be all within the intranet or connected across a private wide-area network. For more details of multiple router setup requirements for UCC, please see “Multiple Routers for UCC Server” in the Mobility Configuration Overview chapter.

The UCC Server requires the following information about each of these routers accessed by the UCC Server:

- Telnnet account to download CME/UC500 configuration for ephones, ephone-dns, hunt groups etc (Note exec level password is required for ephone-dn download).
- Voice Mail Access methods to specify how the calls are to be sent to a user’s mailbox.
- CME Features – specifies some of the CME settings and the internal extension and external access dialing information.
- CME/UC500 location specifies the location of the router from the dial plan perspective.

These changes are made from the Server Wizard - Settings to Access CME/UC500 Features window as shown below.

To Setup the Router Location Parameters:

- Step 1.** Start the Server Wizard
- Step 2.** Click on the CallController Server button in the Home page and then click on Next.
- Step 3.** Select the router that you want to make changes to or enter the information then click on Add to create a new entry.
- Step 4.** Enter the router related information in the “Settings to Access CME /UC 500 Features” page.
- Step 5.** Click on Add to add a new router details or Update to modify an existing setting.

Unified CallConnector Server Setup Wizard

Settings to Access CME/UC500 Features

CME/UC500

- 192.168.1.122
- 192.168.1.121
- 192.168.1.252
- 192.168.1.124

Telnet Access

CME IP-Address: 192.168.1.122 Telnet Password: *****

Telnet User Name: callcomm Exec Password: _____

Voice Mail

Transfer to voice mail method: Using Transfer Script

Transfer to voice mail number: 6000 VM Prefix: 5

Ephones

- Use Hardware conferencing
- Receive connect on remote answer

Extension Length: 4,5

Dial Out Prefix: 9

CME/UC500 Location

Location: Irvine Edit

Country: United States

Area Code: 949

Pattern: [xxx] xxx-xxxx

Clear Add Update Delete

Click on Next to continue.

Home Help < Back Next > Finish

Telnet Access:

Options	Description
CME IP Address	This is the IP Address of the router Cisco CME or UC500. This IP Address is used telnet to the router to download the configuration information.
Telnet User Name	User name of the telnet account to be used for downloading the configuration information.
Telnet Password	Password for the Telnet user account
Exec Password	Exec level password for some specific configuration parameters.

Voice Mail:

Options	Description
Transfer to Voice Mail Method	<p>This lists the supported method for transferring a call to a user's voice mailbox. The Transfer to Voice Mail Script is the recommended method.</p> <ul style="list-style-type: none"> ▪ Transfer to Voice Mail Script: This is a CUE script that automatically answers a call and waits for a voicemail box number. The voice message is recorded and saved into that mailbox. ▪ Use E164 Number: In method requires a separate E164 telephone number to be assigned to each voice mail box. The call is then transferred to this number for recording of message for the associated mailbox. ▪ Use Transfer-to-Voicemail Softkey: This feature requires the version of CME with this Softkey.
Transfer to Voice Mail Number	For the Transfer to Voice Mail using Script, this is the pilot number that is called to reach the CUE Transfer script.
VM Prefix	For the E164 number method, this is the prefix appended to the voicemail box number to generate the user's E164 number.

Ephones:

Options	Description
Use Hardware Conferencing	This parameter specifies that the CME has been configured for hardware conferencing and ad-hoc conference. When this option is checked, the UCC Mobility Service uses the hardware conferencing methods and enabled features that require multiparty conferencing.
Receive Connect on Remote Answer	This parameter is used determine if the call progress states are local or from the far-end device. When analog lines are used to make PSTN calls, the Mobility Server receives ring and connect when the line is seized, while on digital trunks ring and connect states are provided by the terminating end device. The Mobility Server uses this parameter to delay when the prompts are played to the caller. This should be set to true when the CME/UC500 is configured with digital trunks.

Extension Length	Number of digits in the internal extension. If there are several number plans of different extension lengths, then enter all these number lengths separated by commas.
Dial Out Prefix	Digits that have to be appended to the PSTN number, but excluding the long distance code, to make an external call.

CME/UC500 Location:

Options	Description
Location for the Router	The selection of the location sets the country, area code and the number patterns. You can select a pre-defined location or click on Edit to add/modify a location details.
Country	The country in which the router is located, more specifically this is the country code associated with the PSTN network the router is connected to.
Area Code	The telephone Area code of the location.
Pattern	This is the canonical format of the PSTN telephone number for that country and area code.
Edit	This button opens the Edit Location Information window to allow the above location information to be updated.

To Add or Update Router Location Information

- Step 1.** Click on the Edit button in the CME/UC500 Location section
- Step 2.** Click on an existing location to make changes or enter a new location name.
- Step 3.** Select or change the country setting from the pull down list.
- Step 4.** Enter the area code and number pattern.
- Step 5.** Click on Add to add new location details or Update to modify an existing setting.
- Step 6.** Click on Delete to remove a location setting.

Edit Location Information

Location Information

LocationName	Name:	North America - All
Irvine	Country:	United States
North America - All	Area Code:	xxx
	Number Pattern:	(xxx) xxx-xxxx

Buttons: Add, Update, Delete, OK, Cancel

Advanced Dialing Translations for Server

The UCC Server dial plan is used for two different purposes:

- Convert a telephone number to a dialable number. This involves determining if the number is an internal extension or a external PSTN number. In the case of a PSTN number, the Dial Out Prefix is added to the number and the number formatted for local or long distance dialing.
- Convert an incoming number to the 'canonical' format to allow searching for the number in the UCC directories. Numbers in the UCC Directories are saved in a standard format known as 'canonical' format. For example 4085551212 in the United States is formatted to be (408) 555-1212.

The UCC Server uses the router location specification and the information in the uccDialPlan.xml file to convert to a dialable number and a canonical format. Since there may be special local requirements or dialing configurations that have not been covered, the Advanced Dialing Translation provides a method to manually setup dialing translation rules to handle these requirements.

Notes on Dialing Translations

1. The dialing translations are specified for each router. Even if the translations are the same, they will need to be specified for each router.
2. There are two different translations – a) for dialing and b) lookup. Dialing converts a telephone number to a number that can be sent to the CME for dialing out. Lookup converts telephone numbers provides from a) Radius messages – both internal extension and external PSTN numbers and b) caller and called numbers provided through the skinny messages. Both have to be specified based on the format of the numbers.
3. The translations are performed in the specified precedence order until a translation rule is encountered. Processing stops at the first rule that can be executed. All subsequent rules are ignored.
4. Patterns specify the format of the input number to the translation. You can use the letter 'x' to specify any digit. For example xxxx indicates any number that is four digits long and between 9999 and 0000. 'x' should be used when the input number has to be of a specific length. The character period '.' is used to denote any subsequent digits regardless of the length. For example '551.' indicates any number starting with 551 that is greater or equal to four digits in length.
5. The 'Strip' function removes the specified number of starting digits from the input. For example Strip=3 will remove the first three digits from the matching pattern.
6. Pre-pend function appends the specified digits to the front of the number once the Strip function has been performed.

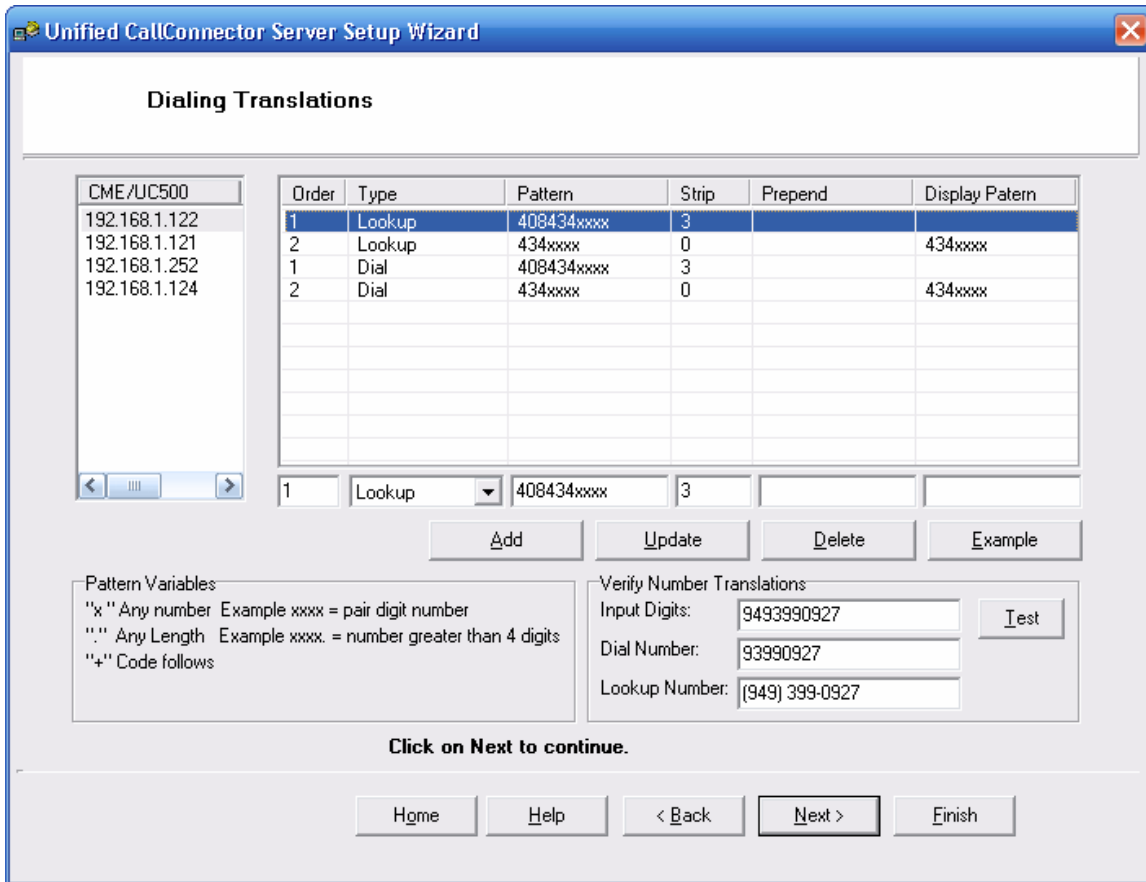

Unified CallConnector Server Setup Wizard

Dialing Translations

CME/UC500	Order	Type	Pattern	Strip	Prepend	Display Pattern
192.168.1.122	1	Lookup	408434xxxx	3		
192.168.1.121	2	Lookup	434xxxx	0		434xxxx
192.168.1.252	1	Dial	408434xxxx	3		
192.168.1.124	2	Dial	434xxxx	0		434xxxx

1 Lookup 408434xxxx 3

Add Update Delete Example

Pattern Variables:
"x" Any number Example xxxx = pair digit number
"." Any Length Example xxxx. = number greater than 4 digits
"+" Code follows

Verify Number Translations
Input Digits: 9493990927 Test
Dial Number: 93990927
Lookup Number: [949] 399-0927

Click on Next to continue.

Home Help < Back Next > Finish

Dial Translation Parameters:

Options	Description
CME/UC 500	This lists the defined CME/UC500 associated with the UCC Server. The dialing translations are specified for each router. To make or edit dialing translations, first select the router.
Order	Order defined the precedence or execution order for the rules. Lookup and Dialing have their separate execution orders. Rules are processed starting with one and moving down the list. Processing stops when there is a match for a pattern.

Type	There are two type of number translations – Lookup for incoming numbers that have to be converted to the canonical format to enable searching in the directories; and Dialing in which canonically formatted numbers are converted to a dialable number with Dial Out codes and Long Distance and Area codes.
Pattern	Pattern is the specification of the input number for which the translations are to be performed. Here 'x' means any number between 0 and 9; '.' Means any number of that length or greater. Examples of patterns include: xxxx -- any four digit number 555xxxx – any seven digit number starting with 555 408xxx. – any number starting with 408 and greater that six digits.
Strip	Remove the specified number of digits from the right of the input numbers.
Pre-Pend	Add the specified numbers to the left of the input number
Display Pattern	The format to associate with the matching input number
Add	Add this as a new rule
Update	Modify and save the selected dialing rule
Delete	Delete the selected dialing rule
Example	Opens a Dialing Rules Examples help document
Input Digits	Enter a number to verify how it will be converted for dialing and lookup given the existing rules. Note make sure you have selected the correct router.
Test	Click on the Test button after you have entered the input number to generate the dialing and lookup numbers.
Dial Number	Conversion of the Input number to a dialing number based on the location and dialing rules
Lookup Number	Conversion of the Input number to a lookup number based on the location and dialing rules

To Setup the Dialing Rule:

- Start the Server Wizard
- Click on the CallController Server button in the Home page and then click on Next.
- Enter the router related information in the “Settings to Access CME /UC 500 Features” page.
- Click on Add to add a new router details or Update to modify an existing setting.

To Setup a Lookup Rule:

- Start the Server Wizard
- Click on the CallController Server button in the Home page and then click on Next.
- Enter the router related information in the “Settings to Access CME /UC 500 Features” page.
- Click on Add to add a new router details or Update to modify an existing setting.

Configure Mobility-Ephones

The UCC Mobility Service is comprised of the Single Number Reach and Dial-IN Access applications. Each of these mobility applications use ephones to answer the incoming call and make the outgoing calls. These ephones have to be provisioned in the CME and then configured for the Mobility Service using the UCC Server Wizard. The ephones provisioned in the CME for use by the mobility applications are referred in this document as the mobility-ephones.

Notes on Mobility Ephones

1. The mobility-ephones can be provisioned for two different types of usage – mobility-ephones that can be used to process any user's mobility service requirements and dedicated mobility-ephones which can only process one specific user's mobility service requirements. The dedicated mobility-ephones typically have a shared appearance DN of the user's primary DN.
2. Mobility application use ephones from the router with the call-terminating ephone. In multiple router configurations, the number of mobility-ephones required on each router is dependent on the number of mobility sessions originated on behalf of users on that router.
3. For incoming calls to the Dial-In Access features, the mobility-ephones are used from the router that received the PSTN call.
4. Mobility-ephones are grouped into pools using the Server Wizard. Such pools can be shared among multiple mobility applications or they can be 'dedicated' to a single mobility application.
5. The mobility applications acquire the needed ephones from the pools and return them back to the pool.
6. If there are multiple pools associated with the application, ephones are acquired first from the dedicated pools, if none are available then from the shared pools.
7. The mobility applications use one ephone for the duration on the session with the following exceptions:
 - a. One additional ephone is used when setting up a new call. For example if the SNR is making two simultaneous reach out calls, then two additional ephones are used, one for each call. Once the reach out call is processed when either the user answers or on timeout, the call is terminated and the ephones are returned to the pool. These ephones will typically be in use for less than a minute.
 - b. If Mid-Call features are enabled, then the SNR session continues for the duration of the call. If Mid-Call features are disabled then all ephones for the SNR session are freed up once the SNR connection is made or the call is sent to voice mail.

Mobility Ephone Setup Overview

The following is a summary of the configuration steps for setting up the mobility-ephones for use by the UCC Mobility Service.

- Provision ephones for use by the UCC Mobility Service on each CME/UC500.
- From the Server Wizard, download all the provisioned ephones and ephone-DNs.
- Select with 'Connect as Softphone' option checked all these mobility-ephones from each of the routers.
- Verify that the ephones have been provisioned correctly with the required ephone-DNs
- Create ephone pools. This gives a name to the pool, specifies if it is shared between applications or is dedicated to one application, and specifies the mobility application(s) that will use the ephones from this pool.
- Allocates the ephones to the pool. In this step, the available ephones are moved to the pools defined in the previous step.

The objective of these configuration steps is to specify for the Single Number Reach and Dial-In Access applications the list of ephones available for use by these applications. The details for each of the configuration steps above are described in detail below.

Provisioning Mobility Ephones

Mobility ephones need to be provisioned on the routers as described in the previous chapter. You can verify the configuration of these ephones using the 'Show Ephone' command from the Command Line Interface (CLI). Examples of the general use ephone and an ephone with a shared appearance DN is showed below.

General Use Ephone:

Shared-Appearance Ephone:

Download CME configuration

The Server Wizard uses the CLI commands over a Telnet connection to download the ephone, ephone-DNs and the hunt group details from the CME. This is a manual step that needs to be repeated if the CME configuration is changed. In multiple router configurations, the ephone details and selection for the UCC needs to be repeated for each router.

To Download CME Configuration Data

Unified CallConnector Server Setup Wizard

Download Configuration Data From CME

Click on Start to re-load configuration data.

CME IP-Address: 192.168.1.122 Telnet Password: *****

Telnet User Name: callcomm Exec Password: (Optional)

Use Exec level Access to download Ephone-dn

Click on start to download data:

Status:

Please wait ...

Database table: EphoneDn is being updated. Please wait ...

Database table: PhonesEphoneDn is being updated. Please wait ...

Database update has been finished. Please wait for telnet session to exit.

Exiting Telnet session. Click Next to Continue.

Start Stop Troubleshoot...

Click on Next to continue.

Home Help < Back Next > Finish

- Step 1.** Open the Server Wizard to the CallController Server and click Next to go to the 'Download Configuration Data from CME' page.
- Step 2.** Enter or select the CME IP Address, the Telnet account name and passwords. 'Use Exec Level Access to download' should be checked.
- Step 3.** Click on Start. The status messages will provide feedback on the progress. Note this step may take some time as the Wizard logs in using the Telnet account and obtains the CME configuration information using:
 - a. 'Show ephone' for ephone configuration
 - b. 'Show run' for the ephone-DNs
 - c. 'Show ephone-hunt' for the hunt groups.

Step 4. The downloaded information is saved in the UCC Databases.

Note:

If you do not have access to the exec level password or if the download does not complete, you can uncheck the 'Use Exec Level Access' option and click on Start again. In this case the ephone-DNs are not downloaded and for each of the selected ephones you will need to 'Verify Connection to ephone' and setup the button information manually.

Select Mobility Ephones

The 'Download CME configuration data' downloads the details on all the ephones in the CME. The 'CallController Server: Select Ephones' page displays this list of ephones in the Ephone tables. This includes the ephones provisioned for use by the Mobility Services. In this configuration step, these mobility-ephones are identified to the UCC system.

Unified CallConnector Server Setup Wizard

CallController Server: Select Ephones

Ephones:

ID	DNs
1	Unregistered
2	4103,4102,4104
3	4110,4107,4453
4	Unregistered
5	4104,4111,4112
6	Unregistered
7	4116,4117,4118
8	4099,74120
9	Unregistered
10	Unregistered
11	4369,4368,4359
12	4368,4367
13	4002,4357
14	4208,4354,4353
15	Registered

Selected Ephones:

Name	DNs	IP Address	ID	Type
28user42	5125, 5126	192.168.1.121	42	2,2
28user43	5127, 5128	192.168.1.121	43	2,2
28user44	5129, 5130	192.168.1.121	44	2,2
28user45	5131, 5132	192.168.1.121	45	2,2
28user46	5133, 5134	192.168.1.121	46	2,2
thien121	5135, 5136	192.168.1.121	47	2,2
38user93	4400, 4401, 4402	192.168.1.122	93	1,1,1
38user94	4403, 4404, 4405	192.168.1.122	94	1,1,1
38user102	4208, 4209, 4210, 4211, 4...	192.168.1.122	102	2,2,2,...

CME IP-Addr: 192.168.1.122

MAC Address: AAAA.BBBB.4372 Connect as Softphone

User Name: 38user93

Password: *****

Ephone ID: 93

DNs: 4400, 4401, 4402

Click on Next to continue.

Home Help < Back Next > Finish

- Step 1.** From the Ephones list, select each one of the mobility-ephones. You will need to know the ephone id or the assigned DN. (Note DN may not be visible as these ephones will not be registered.)
- Step 2.** Check the 'Connect as Softphone' option and click on the Add button below the Ephones list. The 'Selected Ephones' table will display this ephone. The 'Selected Ephones' table contains both the user IP Phone ephone and the mobility ephones.
- Step 3.** View and Verify the mobility-ephone configuration details in the fields below the 'Selected Ephones' table.
- Step 4.** Repeat this process for all the Mobility-Ephones.
- Step 5.** If any parameter is incorrect or if you need to enter the information manually, enter the ephone information in the fields and click on Add or Update. Note – this Add or Update operation will not change the CME configuration.

Verify Mobility Ephones

The 'Verify Connection to Ephone' allows you to connect to the CME and register to the selected ephone and verify that the parameters are accurate and that connection can be established to the CME.

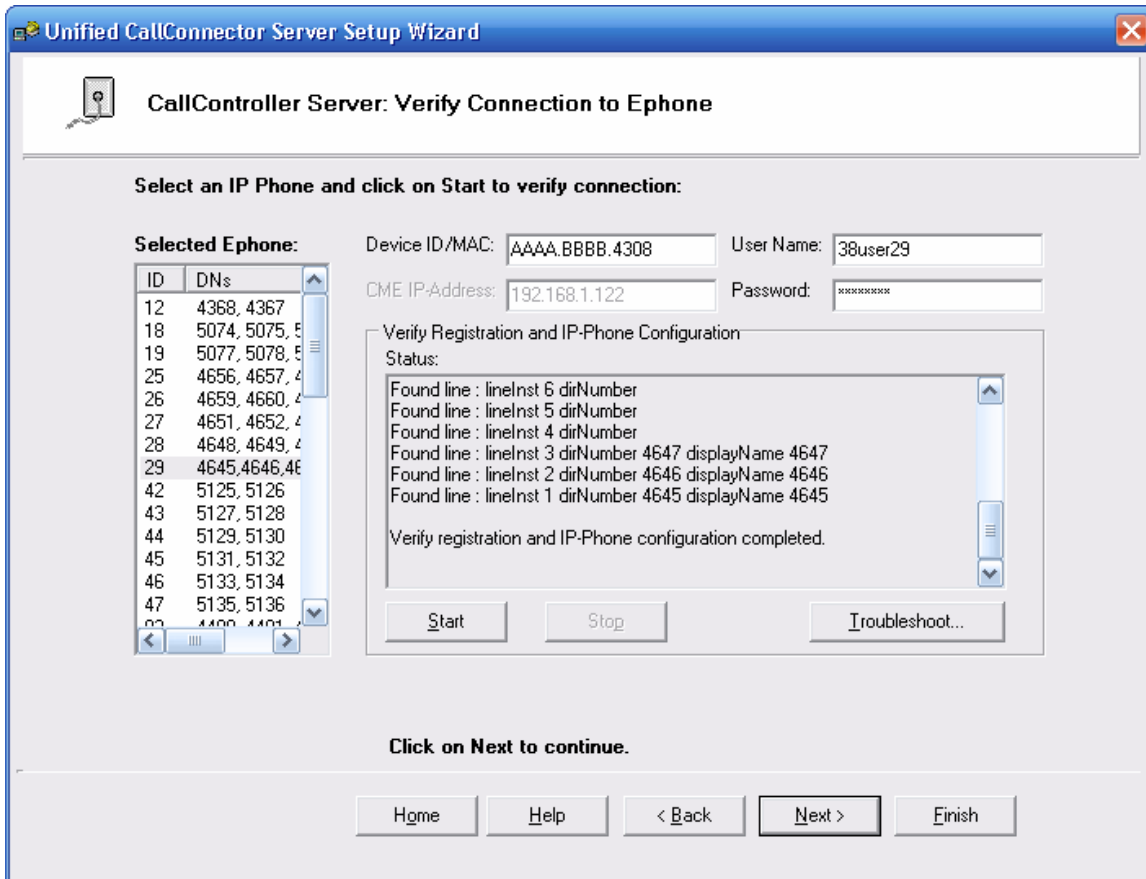

- Step 1.** Click on each ephone and then click on Start
- Step 2.** The Wizard will register to that ephone and display the ephone line configuration details.

Creating Ephone Pools

There are two different types of ephone pool. One is general ephone pool and the other is dedicated ephone pool. The following table shows the comparison between the two different ephone pool types:

	General	Dedicated
Shared	The general ephone pool can be shared by different mobility applications	The dedicated ephone pool can only be used for one application at a time
Applications	SNR w/o Share-Call Appearance DISA Features using Mobility Phone	SNR w/ Share-Call Appearance DISA Features using Dial-in Pool

At least one general ephone pool is required for the Single Number Reach (SNR) to work. If you want to use the Share-Call Appearance feature, then at least one dedicated ephone pool will be needed. The following table illustrates the required ephone pool setup for various Single Number Reach functions:



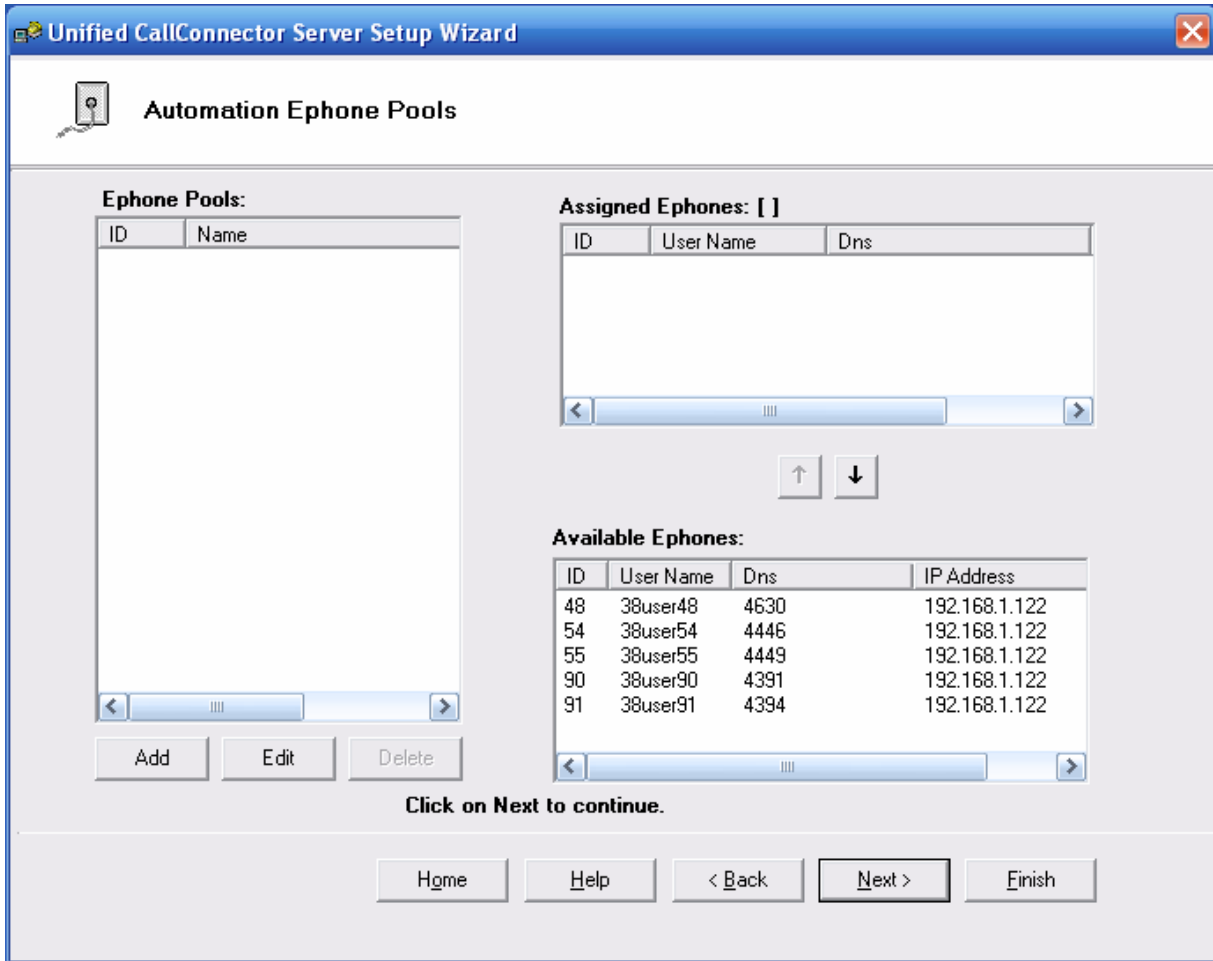

General Phone Pool / Dedicated Phone Pool

SNR Functions	Enable	Disable
Share-Call Appearance	Dedicated and General	General
Mid-Call Features	General	General

The following window allows you to add, update, and remove ephone pools; it also let you assign available ephones to the phone pools.

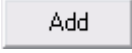
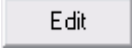

Tables	Description
Ephone Pools	A list of ephone pools currently setup for Mobility applications.
Assigned Ephones	A list of ephones that are assigned for the ephone pool selected in the ephone pool list.
Available Ephones	A list of ephones that is available to be assigned to ephone pools.

Buttons	Description
	Assign an ephone from the available ephone list to a selected ephone pool.
	Remove an ephone from the assigned ephone list.
	Add a new ephone pool.
	Edit a selected ephone pool.
	Delete a selected ephone pool.

To Create an ephone Pool

Step 1. To create an ephone pool, click on the  button then an “Add Application Pool” window will pop up for you to assign applications to the ephone pool*.

Step 2. Enter a name for the ephone pool

Step 3. Select YES if it is a dedicated ephone pool**.

Step 4. Assign the applications from the available application list to the ephone pool by selecting an application and click on the  button. Click OK when finished.

* If the ephone pool is dedicated, then only one application can be assigned to it.



** For Share-Call Appearance, the ephone pool needs to be dedicated.

Buttons	Description
	Add a selected application from the available application list to the ephone pool.
	Remove an application from the selected application list.

Options	Description
Pool Name	Assign a name to identify the ephone pool.
Dedicated	Select "Yes" to make the ephone pool dedicated.
Available Application	Applications that are available to be assigned for the ephone pool.
Selected Application	Applications that are added to the list will use the ephones in the ephone pool to make calls.

Assign ephones to ephone Pools:

Once an ephone pool is created, you can assign ephones from the “Available Ephone” list to an ephone pool that is being selected in the ephone pool list.

- Step 1.** Select an ephone from the available ephone list then click  to assign the ephone. The ephone being assigned will be listed in the “Ephone Pools” list.
- Step 2.** Repeat for all the ephones you want to add this ephone pool.
- Step 3.** If you want to remove an ephone from the ephone pool, select an ephone from the assigned ephone list and click  to remove.

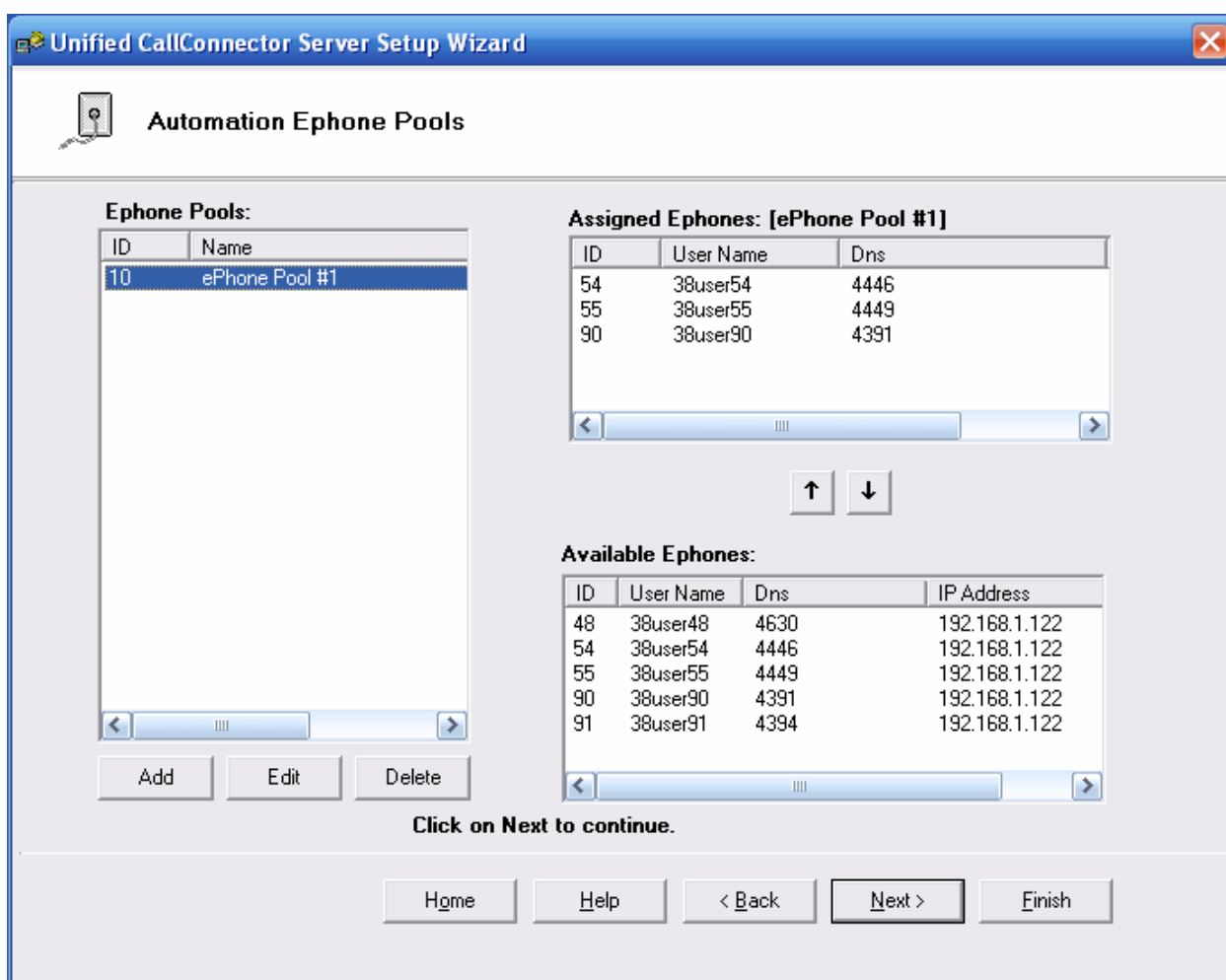

Add ePhones with Shared DN to Dedicated Ephone Pool:

After you setup one or more ephones that have shared-DNs, you would need to create a separate ephone pool for Share-Call Appearance. When you create a new ephone pool, make sure that you

select **Yes** on the “Dedicated” option and assign applications to the ephone pool from the available application list.

To provide the SNR, Mid-Call and DISA features, the UCC Server with Mobility Services has to be installed and the Mobility Service has to be registered.

Setup SNR and DISA System Parameters

To setup Automation Mobility Service, click on Windows Start button -> All Programs -> Cisco Systems -> Cisco Unified CallConnector Server -> click on Cisco Unified CallConnector Server Wizard. Once the server wizard window is loaded, you select **Automation/Mobility Server** from the home menu and click on Next once. Then you’ll see the following window which allows you to configure the settings for Single Number Reach (SNR) and Dial-in System Access (DISA) features of the Cisco Unified CallConnector Mobility Service.

The window has all the configuration settings for the Automation Mobility Service. If you want users to access to the Mid-Call Features then you can check **Allow mid-call to features access** to enable the feature. The option **Maximum number of calls to locate user** limits the number of simultaneous calls can be made to a user per incoming call. You can decide the timeout interval (in seconds) for user to answer the reached call. Also, you can specify the maximum number of SNR session to be established concurrently.

In the Dial-in-Access Options, you can enable the DISA features by checking **Allow Dial-in access**. If you don’t want to allow users to access the DISA features from phones that are not in users’ contact directory, you can check **Restrict Dial-in to user contact numbers** to restrict users to access the DISA features from their work, home or mobile phone only. If security is your concern, you can enforce every user to provide DISA password before they can access the DISA features by checking **Always authenticate with dial-in password**. Next to the options you see a list box containing DISA pilot numbers. There are two configurations that you can use to setup DISA pilot numbers. One is to use Dial-in pool which requires you to allocate at least one ephone pool set to be dedicated and assign DISA application to use the ephone pool. Each ephone assigned to the ephone pool is ready for one DISA session. Whatever DNs belong to the ephone pool can be used as the DISA pilot number. Another configuration requires you to setup a mobility ephone (*NOT* assigned to any ephone pool) and an ephone pool set to be not dedicated and assign DISA application to it. As a result, any DNs in the mobility ephone would become the DISA pilot number. If you want to use the 2nd configuration, then you need to click on **Edit** to add the DISA pilot number manually to the DN list.

For both SNR and DISA applications, you can decide whether you want users to be able to view the caller’s number when there’s an incoming call or they try to reach to other contacts by checking **Show caller number for Mobility Service Calls**. You can specify if the length of the caller number is less than certain digits then the caller number either will be transformed to a full length custom PSTN number or the caller number will be appended to the custom prefix number with **as prefix** checked.

The screenshot shows the 'Automation Mobility Service' configuration window. It is divided into several sections:

- Single Number Reach Options:** Includes checkboxes for 'Allow mid-call to features access' (checked), 'Maximum number of calls to locate user' (4), 'Timeout for user answer (seconds):' (20), and 'Maximum number of SNR session:' (25).
- Dial-in-Access Options:** Includes checkboxes for 'Allow Dial-in access' (checked), 'Restrict Dial-in to user contact numbers' (checked), 'Always authenticate with Dial-in Password' (checked), and 'Hide Caller Phone Number' (checked). It also features a 'DNs' list with values 4400, 4403, and 5074, and radio buttons for 'Use Dial-in Pool' (selected) and 'Enter Number'.
- Transmit Caller Phone Number:** Includes a checked box for 'Show caller number for Mobility Service Calls', a field for 'If caller number is less than 4, 5 digits then send' (949399), and a list of IP addresses for 'Select an IP to update caller id forwarding settings' (CME, 192.168.1.122, 192.168.1.121, 192.168.1.252, 192.168.1.124).
- Automation User Account:** Includes 'Login Name: automationuser' and a masked 'Password:' field.

At the bottom, there are navigation buttons: Home, Help, < Back, Next >, and Finish. A message 'Click on Next to continue.' is displayed above the buttons.

Single Number Reach Options:

Options	Description
Allow mid-call access to features	Check to enable/Uncheck to disable the Mid-Call Features after a SNR session is established.
Maximum number of calls to locate users	Select a number to set the maximum number of calls can be made to locate users.
Timeout for user answer (Seconds)	Select a timeout period (in seconds) for the SNR to hang-up the calls if users cannot be located.
Maximum number of SNR session	Define a maximum number of SNR session can be established concurrently.

Dial-in Access Options:

Options	Description
Allow Dial-in access	Check to enable/Uncheck to disable the Dial-in Access Feature.
Restrict to user contact numbers	Check to restrict the access to Dial-in Access Feature only from the numbers that are in the user's own contact list.
Authenticate with Dial-in password	Check to enforce Dial-in password authentication.*
Hide Caller Phone Number	This options hides the user personal telephone number by not transmitting it as the caller id, instead the mobility ephone number is displayed.
Use Dial-In Pool	This option indicates that the Dial-In Access should answer incoming calls the ephones defined in the ephone pools specified for this feature.
Insert Number	This option indicates that the Dial-In Access should pick up ringing calls to this DN. Generally a hunt group will be set up to point to these DNs.

* If the extension number you enter or dial from is shared by other users, you'll still be prompt for your dial-in password even with the option "Authenticate with Dial-in password" disabled.

Transmit Caller Phone Number:

Options	Description
Show caller number for Mobility Service Calls	Check to enable/Uncheck to disable showing caller number to the contacts who are receiving Mobility Service Calls.
If caller number is less than x digits	Specify the length of caller number to be transformed to a custom number.
Fixed number to be sent	Specify the custom number that will be used to display the caller's number.
As prefix	Check to indicate the custom number is a prefix number to be pre-pended to the caller number.

Note: The internal number length and the prefix or fixed number for transmission as the caller-id is specified per router. In multiple router configurations, select each router and setup the parameters.

Holiday and Work Day/Time Schedules

The holiday and work day and work hours are used in the user specified rules for call routing. This Wizard page Holiday Schedule lets the administrator setup this information for the organization.

Unified CallConnector Server Setup Wizard

✓ **Holiday Schedule**

Holidays:

Date	Description
12/25/2007	Christmas

Date: 12/25/2007

Description: Christmas

Clear Add Update Delete

Work Day Start Time: 08:30 Work Day End Time: 18:30

Working Days: Monday Tuesday Wednesday Thursday Friday
 Saturday Sunday

Click on Next to continue.

Home Help < Back Next > Finish

To Setup Holiday Schedule

- Step 1.** Select the Holiday date from the calendar button.
- Step 2.** Enter the name or description of the holiday and click on Add.
- Step 3.** To Update a Holiday, select that holiday in the Holidays list. Make the changes in the Date and Description fields and click on Update.
- Step 4.** To Delete a Holiday, select the holiday from the Holidays list and click on Delete.

To Setup Working Hours

From the pull down list select the start and end times to set the working hours for the organization.

To Setup Working Days

Check the days which are working days for your organization.

Update User Contact Details

Voice Mail, Tel PIN and DISA PIN have been added to the user's contact information.

Voice mail: This is the user's voice mail box number. By default this is set to the Business number.

Tel PIN: This is the password entered to authenticate the user for SNR calls.

DISA PIN: This is the user's password for using the Dial-In Access features.

Unified CallConnector Server Setup Wizard

Data Configuration - User Table

User Table:		Users Default:		Users Contacts:	
User ID	Display Name	User ID:	186	Business:	4293
208	Karl Malone	First Name:	Nobita	Business2:	1111
190	Kendo Math	Last Name:	Kamashi	Home:	(949) 3990937
193	Kobe Bryant	Login Name:	cc2	Mobile:	(949) 3990927
192	Kojo Natash	Password:	xxxx	Email:	admin@callcomm.com
207	Kojo Shoot	Company:	CallComm Technologies Inc	SMS:	9493990927@tmomail.net
203	Lamar Odom	User Type:	Manager	IM:	cc2
189	Misaki Mahil	Group:	Sales	Voicemail:	4104
186	Nobita Kama	Serial No:	UCCS-0100-xxxxxxxxxx	Tel PIN:	321
198	Phil Jackson			DISA PIN:	999
196	Rick Fox				
197	Robert Horry				
201	Samaki Wal				
194	Shaq O'neal				
202	Shasa Vujasic				
185	Sonny Hoar				
187	Subasa Leo				
206	Tekki Kiem				

Refresh [Icon]

Clear Add Update Delete

Click on Next to continue.

Home Help < Back Next > Finish

TROUBLESHOOTING

This chapter describes the common error conditions that occur with the Unified CallConnector Mobility Service and steps to solving these problems.

Mobility Features Troubleshooting

Single Number Reach doesn't work:

Description	The SNR does not launch after a personal routing policy is created.
Possible Causes	<ul style="list-style-type: none"> Automation server is not running The ephones in CME are not available The personal routing policy is not setup correctly
Procedures	<p>Step 1. Launch the CTIServer Server Manager to check the automation server status making sure it is "Started". If not, click Stop and wait until all servers are stopped then click Start.</p> <p>Step 1. Launch the Cisco CallConnector Server Wizard and go to the Automation Ephone Pool setup page to verify the ephone pool setup making sure the ephones are assigned correctly. Also, it is required to assign SNR application to at least one ephone pool.</p> <p>Step 2. Check the personal routing policy's condition checks. Making sure all the enabled conditions are matched.</p>

The Mid-Call Features doesn't work:

Description	The Mid-Call Features doesn't respond to the user's input once an SNR session is established.
Possible Causes	<ul style="list-style-type: none"> Mid-Call Features is not enabled Hardware Conferencing is not enabled
Procedures	<p>Step 1. Launch the Cisco CallConnector Server Wizard and go to the Automation Mobility Service setup page.</p> <p>Step 2. Check the "Allow mid-call to access features" option is enabled in the Single Number Reach Options section.</p> <p>Step 3. Go to the Settings to Access CME/US500 Features setup page making sure that the option "Use Hardware</p>

	conferencing” is checked.
--	---------------------------

The reached call gets dropped when the user answers it:

Description	When the mobility service gets the incoming call and tries to route the call to the user, the reached call gets dropped too fast.
Possible Causes	<ul style="list-style-type: none"> • Timeout for user answer setting might be too short
Procedures	<p>Step 1. Launch the Cisco CallConnector Server Wizard and go to the Automation Mobility Service setup page to increase the Timeout for user answer value.</p>

The Dial-in System Access doesn't work:

Description	The Dial-in System Access doesn't work when the user calls the DISA pilot number.
Possible Causes	<ul style="list-style-type: none"> • Automation server is not running • DISA features is not enabled • No pilot number or ephone assigned for DISA pilot number configuration
Procedures	<p>Step 1. Launch the CTIServer Server Manager to check the automation server status making sure it is “Started”. If not, click Stop and wait until all servers are stopped then click Start.</p> <p>Step 2. Launch the Cisco CallConnector Server Wizard and go to the Automation Mobility Service setup page making sure that the option Allow Dial-in access is checked.</p> <p>Step 3. Check the DNs list box in the Dial-in Access Options section making sure the DISA pilot number that the user called is in the list. If the pilot number you intend to use is not in the list, then you need to assign an ephone that has the pilot number to an ephone pool set to be dedicated and assign the DISA application to the ephone pool.</p>

The Mobility Service doesn't play custom recorded voice prompt:

Description	The mobility service doesn't play custom voice prompt that users recorded.
Possible Causes	<ul style="list-style-type: none"> • Language setting is incorrect • Location of the prompt files are invalid • Audio format of the prompt files are invalid
Procedures	<p>Step 1. Launch the Cisco CallConnector Server Wizard and make sure the language setting on the first setup page is selected as "Custom"</p> <p>Step 2. The location of the prompt files must be the <i>Cisco Unified CallConnector Server installation path</i>\Wave\Custom directory.</p> <p>Step 3. The required audio format criteria for custom recorded voice prompt are:</p> <ul style="list-style-type: none"> • Bit Rate: 128kbps • Audio Sample Size: 16bit • Channels: 1(mono) • Audio Sample Rate: 8bit • Audio Format: PCM

Rules Diagnostics Tool

The Personal Routing Policy Diagnostics Tool helps administrator or support personnel troubleshoot the problem of users' personal routing policy issues. You can effectively use this diagnostics tool to monitor activities that are happening between UCC client and mobility server to have a better picture why a routing policy fails. To start using the tool:

- Step 1.** Make sure the mobility service is started
- Step 2.** Launch the diagnostics tool located in *Cisco Unified CallConnector Server installation path*\Tools\ASDiags.exe
- Step 3.** Enter username and password then press OK for the tool to be authenticated in order to connect to mobility server.

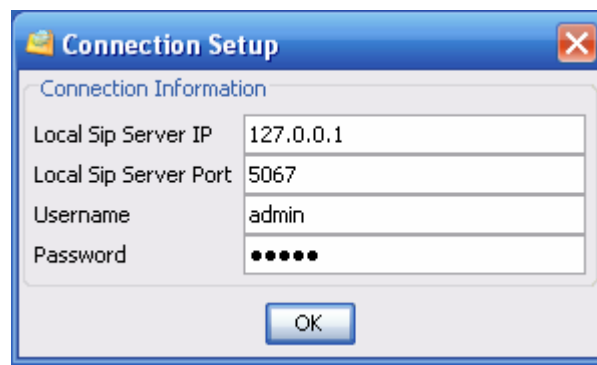

- Step 4.** The following screen is the main window of the diagnostics tool. To verify the connection is successfully established, click **Show monitor** and you'll see a "SIPoid is now connected" message. To monitor a user's policy, you can click **New Monitor For A User** and get a list of personal routing policies for a user by supplying either username or user id. Of course if you want to monitor more than one rule at the same time you can click **New Monitor For A User** again to create another new rule monitor.

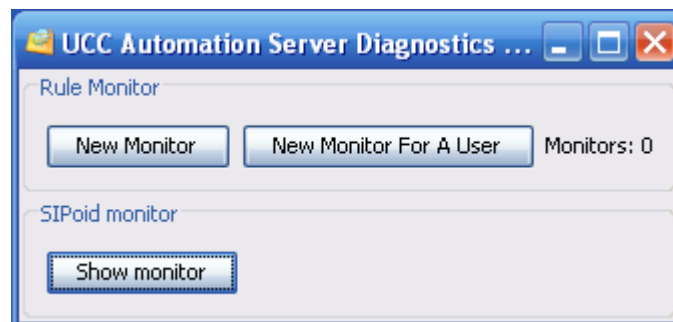

- Step 5.** Once you click **New Monitor For A User**, you can retrieve a list of a user's routing policies by entering the username or user id. Then click **Query user's rules** will return all the routing policies that belong to the user. You can select a rule that you want to monitor and click OK.

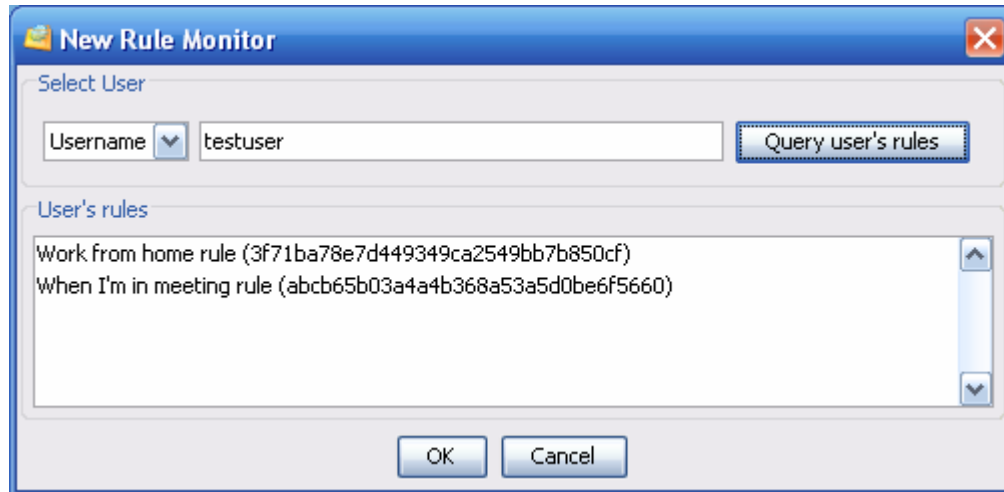

- Step 6.** The following rule monitor displays detail information of a routing policy that's successfully launched. When a rule is launched with all of its conditions matched, you'll see an event is added to the event list with a green check icon meaning the actions that are specified in the rule will execute. However, if you don't see any green check icon and all you see is red X icon, it indicates one or more conditions failed to match. In that case, you can select an event in the event list and find more detail information in the lower part of the rule monitor to see which unmatched conditions caused the rule fail to launch.

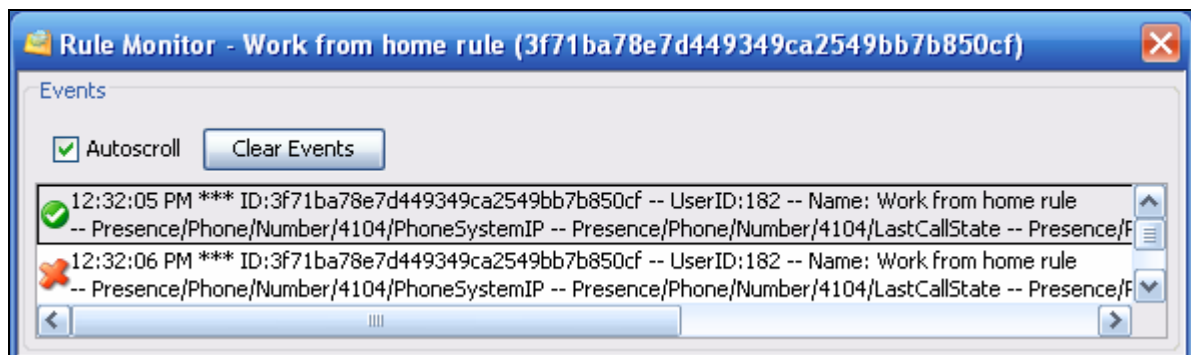

- Step 7.** In **Event detail**, you can tell right away why the rule fails to launch by looking at the **Condition** section. As you can see in the following screenshot, there are 4 conditions to be evaluated when an event occurs. The green check icon and **TRUE** indicate the condition is matched. Otherwise, the red X icon and **FALSE** indicate the condition isn't matched. The following table illustrates the pre-defined conditions and actual condition:

Conditions need to be matched	Actual event or condition
Calls come to this number: 4104	4104 is ringing
My location is: Home	My location is set to Home
My Status is: Available	My status is set to Unavailable

Obviously, you can see why the rule didn't launch. Because the actual status is **Unavailable** but not **Available**, it stops the rule from executing pre-defined actions as result. Besides telling you the condition matches or not, the rule monitor allows you to view the actual condition attribute. If you see red borders appear when you hover over a condition block with your mouse, then you're able to view the inner attribute for that condition by clicking your mouse once. In the following screenshot, the left block within the condition "My Status is 'Available'" represents the actual condition and the right block is the pre-defined condition.

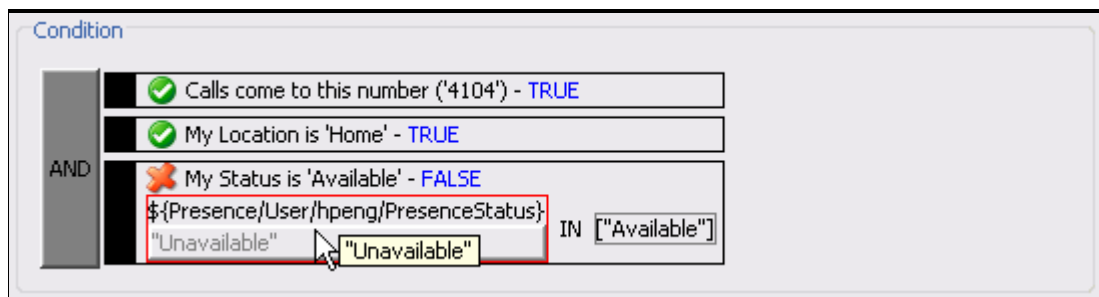

- Step 8.** After identifying where the problem is, you can verify with the user and ask for adjustment to either the pre-defined or actual condition if necessary.

APPENDIX A

Replace Voice Prompt with Custom Recorded Files:

The voice prompts for Cisco CallConnector Mobility Service can be customized to your preferred language. The easiest way to replace with your custom voice prompts is to copy all the files from **Cisco Unified CallConnector Server installation path**\Wave\US English-Female to **Cisco Unified CallConnector Server installation path**\Wave\Custom. From the table below, you can see the content of each wave file and record your custom voice prompt then overwrite the files accordingly. Finally, you need to make sure that the language setting in the server wizard is set to "Custom".

NOTE: The wave files need to have the following format:

- Bit Rate: 128kbps
- Audio Sample Size: 16bit
- Channels: 1(mono)
- Audio Sample Rate: 8bit
- Audio Format: PCM

File Name	Script / Description	Length (sec)
cchelpmenu.wav	Help menu Press *1 to change status Press *2 to change location Press *4 to transfer to a number Press *5 to add number to conference Press *6 to transfer to mobile phone Press *7 to transfer to work phone Press *8 to transfer to home phone Press *9 to transfer to voicemail Press ## to end mid-call features Press *0 to repeat the menu	28
cctryingothernumbers.wav	Trying other numbers, please hold	3
ccenterpassword.wav	Please enter your password	2
ccreenterpassword.wav	Invalid entry, please reenter your password	4
cconfirm.wav	(Confirmation tone)	1
cccanceldtmf.wav	(Cancel tone)	1
cctransfertoworkfail.wav	Transfer to work phone failed	2
cctransfertohomefail.wav	Transfer to home phone failed	2
cctransfertomobilefail.wav	Transfer to mobile phone failed	2

cctransfertovoicemailfail.wav	Transfer to voicemail failed	2
cctransferfail.wav	Transfer failed	2
cctransferenternumber.wav	Enter a number to transfer and press #	3
ccaddconferencefail.wav	Adding number to the conference failed	3
ccaddconferenceenternumber.wav	Enter a number to add to the conference and press #	3
ccchangestatusmenu.wav	Press 1 change to available Press 2 change to unavailable Press 3 change to away Press 4 change to busy	9
ccchangestatusavailable.wav	Your current status is available	3
ccchangestatusunavailable.wav	Your current status is unavailable	3
ccchangestatusaway.wav	Your current status is away	2
ccchangestatusbusy.wav	Your current status is busy	2
ccchangestatusfail.wav	Changing status failed	2
ccchangelocationmenu.wav	Press 1 change to home Press 2 change to work Press 3 change to road Press 4 change to vacation	8
ccchangelocationhome.wav	Your current location is home	2
ccchangelocationwork.wav	Your current location is work	2
ccchangelocationroad.wav	Your current location is road	2
ccchangelocationvacation.wav	Your current location is vacation	3
ccchangelocationfail.wav	Changing location failed	2
disasystemerror.wav	System is unavailable now, please try again later	4
disanoaccess.wav	We're sorry! You do not have access to the system. Goodbye.	4
disaenterextnumber.wav	Please enter your extension number	2
disareenterextnumber.wav	Invalid entry, please reenter your extension number	4
disaenterpassword.wav	Please enter your password	2
disareenterpassword.wav	Invalid entry, please reenter your password	4
disapwauthenticationfail.wav	Invalid password. Goodbye.	3
disaextauthenticationfail.wav	Invalid extension number. Goodbye.	3

APPENDIX B

CME Conferencing

DETAILED STEPS

	Command or Action	Purpose
Step 1	enable Example: Router> enable	Enables privileged EXEC mode. <ul style="list-style-type: none"> Enter your password if prompted.
Step 2	configure terminal Example: Router# configure terminal	Enters global configuration mode.
Step 3	voice-card slot Example: Router(config)# voice-card 2	Enters voice-card configuration mode and configure a voice card.
Step 4	dsp services dspfarm Example: Router(config-voicecard)# dsp services dspfarm	Enables digital-signal-processor (DSP) farm services for a particular voice network module.
Step 5	exit Example: Router(config-voicecard)# exit	Exits voice-card configuration mode.

Configuring Join and Leave Tones

DETAILED STEPS

	Command or Action	Purpose
Step 1	enable Example: Router> enable	Enables privileged EXEC mode. <ul style="list-style-type: none">Enter your password if prompted.
Step 2	configure terminal Example: Router# configure terminal	Enters global configuration mode.
Step 3	voice class custom-cptone <i>cptone-name</i> Example: Router(config)# voice class custom-cptone jointone	Creates a voice class for defining custom call-progress tones to be detected.
Step 4	dualtone conference Example: Router(cfg-cptone)# dualtone conference	Configures conference join and leave tones.
Step 5	frequency <i>frequency-1</i> [<i>frequency-2</i>] Example: Router(cfg-cp-dualtone)# frequency 600 900	Defines the frequency components for a call-progress tone.
Step 6	cadence { <i>cycle-1-on-time cycle-1-off-time</i> [<i>cycle-2-on-time cycle-2-off-time</i>] [<i>cycle-3-on-time cycle-3-off-time</i>] [<i>cycle-4-on-time cycle-4-off-time</i>]} continuous Example: Router(cfg-cp-dualtone)# cadence 300 150 300 100 300 50	Defines the tone-on and tone-off durations for a call-progress tone.
Step 7	end Example: Router(cfg-cp-dualtone)# exit	Exits configuration mode and enters privileged EXEC mode.

Configuring SCCP for Cisco Unified CME

DETAILED STEPS

	Command or Action	Purpose
Step 1	enable Example: Router> enable	Enables privileged EXEC mode. <ul style="list-style-type: none"> Enter your password if prompted.
Step 2	configure terminal Example: Router# configure terminal	Enters global configuration mode.
Step 3	sccp local <i>interface-type interface-number</i> [port <i>port-number</i>] Example: Router(config)# sccp local FastEthernet0/0	Selects the local interface that SCCP applications (transcoding and conferencing) use to register with Cisco Unified CME.
Step 4	sccp ccm {ip-address <i>dns</i> } identifier <i>identifier-number</i> [priority <i>priority</i>] [port <i>port-number</i>] [version <i>version-number</i>] Example: Router(config)# sccp ccm 1.4.158.3 identifier 100 version 4.0	Adds a Cisco Unified CME router to the list of available servers and set various parameters—including IP address or Domain Name System (DNS) name, port number, and version number. <ul style="list-style-type: none"> <i>version-number</i>—Must be 4.0 or later.
Step 5	sccp ccm group <i>group-number</i> Example: Router(config)# sccp ccm group 123	Creates a Cisco Unified CME group.
Step 6	bind interface <i>interface-type interface-number</i> Example: Router(config-sccp-cm)# bind interface fastethernet 0/0	Binds an interface to a Cisco Unified CME group.
Step 7	exit Example: Router(config-sccp-cm)# exit	Exits SCCP Cisco Unified CME configuration mode.

Step 8	<pre>sccp</pre> <p>Example:</p> <pre>Router(config)# sccp</pre>	Enables SCCP and its related applications (transcoding and conferencing).
Step 9	<pre>exit</pre> <p>Example:</p> <pre>Router(config)# exit</pre>	Exits global configuration mode.

Configuring the DSP Farm

To configure the DSP farm profile for multi-party ad hoc and meet-me conferencing, perform the following steps.

Note: The DSP farm can be on the same router as the Cisco Unified CME or on a different router.

DETAILED STEPS

	Command or Action	Purpose
Step 1	<pre>enable</pre> <p>Example:</p> <pre>Router> enable</pre>	<p>Enables privileged EXEC mode.</p> <ul style="list-style-type: none"> Enter your password if prompted.
Step 2	<pre>configure terminal</pre> <p>Example:</p> <pre>Router# configure terminal</pre>	Enters global configuration mode.
Step 3	<pre>dspfarm profile <i>profile-identifier</i> conference</pre> <p>Example:</p> <pre>Router(config)# dspfarm profile 1 conference</pre>	Enters DSP farm profile configuration mode and defines a profile for DSP farm services.
Step 4	<pre>codec {<i>codec-type</i> pass-through}</pre> <p>Example:</p> <pre>Router(config-dspfarm-profile)# codec g711ulaw</pre>	<p>Specifies the codecs supported by a DSP farm profile.</p> <p>Note Repeat this step as necessary to specify all the supported codecs.</p>
Step 5	<pre>conference-join custom-cptone <i>cptone-name</i></pre> <p>Example:</p>	<p>Associates a custom call-progress tone to indicate joining a conference with a DSP farm profile.</p> <p>Note The <i>cptone-name</i> argument in this step must be the same as the <i>cptone-argument</i> in the voice</p>

	Router(config-dspfarm-profile)# conference-join custom-cptone jointone	class custom-cptone command configured in the "SCCP: Enabling DSP Farm Services for a Voice Card" section .
Step 6	conference-leave custom-cptone <i>cptone-name</i> Example: Router(config-dspfarm-profile)# conference-leave custom-cptone leavetone	Associates a custom call-progress tone to indicate leaving a conference with a DSP farm profile. Note The <i>cptone-name</i> argument in this step must be the same as the <i>cptone-argument</i> in the voice class custom-cptone command configured in the "SCCP: Enabling DSP Farm Services for a Voice Card" section .
Step 7	maximum conference-party <i>max-parties</i> Example: Router(config-dspfarm-profile)# maximum conference-party 32	(Optional) Configures the maximum number of conference parties allowed in each meet-me conference. The maximum is codec-dependent.
Step 8	maximum sessions <i>number</i> Example: Router(config-dspfarm-profile)# maximum sessions 8	Specifies the maximum number of sessions that are supported by the profile.
Step 9	associate application sccp Example: Router(config-dspfarm-profile)# associate application sccp	Associates SCCP with the DSP farm profile.
Step 10	end Example: Router(config-dspfarm-profile)# end	Exits to privileged EXEC mode.

Associating Cisco Unified CME with a DSP Farm Profile

DETAILED STEPS

	Command or Action	Purpose
Step 1	enable Example: Router> enable	Enables privileged EXEC mode. <ul style="list-style-type: none"> Enter your password if prompted.
Step 2	configure terminal Example: Router# configure terminal	Enters global configuration mode.
Step 3	sccp ccm group <i>group-number</i> Example: Router(config)# sccp ccm group 1	Creates a Cisco Unified CME group.
Step 4	associate ccm identifier-number priority priority-number Example: Router(config-sccp-ccm)# associate ccm 100 priority 1	Associates a Cisco Unified CME router with the group and establishes its priority within the group.
Step 5	associate profile <i>profile-identifier</i> register <i>device-name</i> Example: Router(config-sccp-ccm)# associate profile 2 register confdsp1	Associates a DSP farm profile with the Cisco Unified CME group. <ul style="list-style-type: none"> <i>device-name</i> is a maximum of 16 characters. Note Repeat this step for every conferencing DSP farm and transcoding DSP farm.
Step 6	end Example: Router(config-sccp-ccm)# end	Exits to privileged EXEC mode.

Enabling Multi-Party Ad Hoc and Meet-Me Conferencing

DETAILED STEPS

	Command or Action	Purpose
Step 1	enable Example: Router> enable	Enables privileged EXEC mode. <ul style="list-style-type: none">Enter your password if prompted.
Step 2	configure terminal Example: Router# configure terminal	Enters global configuration mode.
Step 3	telephony-service Example: Router(config)# telephony-service	Enters telephony-service configuration mode.
Step 4	conference hardware Example: Router(config-telephony)# conference hardware	Configures a Cisco Unified CME system for multi-party conferencing only.
Step 5	sdspfarm units <i>number</i> Example: Router(config-telephony)# sdspfarm units 3	Specifies the maximum number of DSP farms that are allowed to be registered to the SCCP server.
Step 6	sdspfarm tag number device-name Example: Router(config-telephony)# sdspfarm tag 2 confdsp1	Permits a DSP farm to register to Cisco Unified CME and associates it with a SCCP client interface's MAC address. Note The <i>device-name</i> in this step must be the same as the <i>device-name</i> in the associate profile command in Step 5 of the "SCCP: Associating Cisco Unified CME with a DSP Farm Profile" section .
Step 7	sdspfarm conference mute-on <i>mute-on-digits</i> mute-off <i>mute-off-digits</i>	Defines mute-on and mute-off digits for conferencing. <ul style="list-style-type: none">Maximum: 3 digits. Valid values are the

	Example: Router(config-telephony)# sdsfarm conference mute-on 111 mute-off 222	numbers and symbols that appear on your telephone keypad: 1, 2, 3, 4, 5, 6, 7, 8, 9, 0, *, and #. • Mute-on and mute-off digits can be the same.
Step 8	end Example: Router(config-telephony)# end	Exits to privileged EXEC mode.

Configuring Multi-Party Ad Hoc Conferencing and Meet-Me Numbers

DETAILED STEPS

	Command or Action	Purpose
Step 1	enable Example: Router> enable	Enables privileged EXEC mode. • Enter your password if prompted.
Step 2	configure terminal Example: Router# configure terminal	Enters global configuration mode.
Step 3	ephone-dn <i>dn-tag</i> dual-line Example: Router(config)# ephone-dn 18 dual-line	Enters ephone-dn configuration mode for the purposes of creating and configuring an extension (ephone-dn) for a Cisco Unified IP phone line. • Each ephone-dn can carry two parties if it is configured as a dual line. • Configure enough ephone-dns to accommodate the maximum number of conference participants to be supported. • For multi-party ad hoc conferencing, maximum number of directory numbers is 8, but you can configure a lower maximum. • For meet-me conferencing, maximum number of directory numbers is 32, but you can configure a lower maximum.

		<ul style="list-style-type: none"> Minimum number of directory numbers required: 2.
Step 4	<p>number <i>number</i> [<i>secondary number</i>] [<i>no-reg</i> [<i>both</i> <i>primary</i>]]</p> <p>Example:</p> <pre>Router(config-ephone-dn)# number 6789</pre>	<p>Associates a telephone or extension number with an ephone-dn in a Cisco Unified CME system.</p> <ul style="list-style-type: none"> Each DN for a conference must have the same primary and secondary number.
Step 5	<p>conference ad-hoc</p> <p>or</p> <p>conference meetme</p> <p>Example:</p> <pre>Router(config-ephone-dn)# conference ad-hoc</pre> <p>or</p> <pre>Router(config-ephone-dn)# conference meetme</pre>	<p>Configures a number as a placeholder for ad hoc conferencing to associate the call with the DSP farm.</p> <p>or</p> <p>(Optional) Associates meet-me conferencing with a directory number.</p>
Step 6	<p>preference preference-order [<i>secondary secondary-order</i>]</p> <p>Example:</p> <pre>Router(config-ephone-dn)# preference 1</pre>	<p>Sets dial-peer preference order for an extension (ephone-dn) associated with a Cisco Unified IP phone.</p> <ul style="list-style-type: none"> Remember to configure "preference x" with low value to last DN. The lower the value of the <i>preference-order</i> argument, the higher the preference of the extension.
Step 7	<p>no huntstop [<i>channel</i>]</p> <p>Example:</p> <pre>Router(config-ephone-dn)# no huntstop</pre>	<p>Continues call hunting behavior for an extension (ephone-dn) or an extension channel.</p> <ul style="list-style-type: none"> Remember to configure no huntstop for all DNs except the last one.
Step 8	<p>end</p> <p>Example:</p> <pre>Router(config-ephone-dn)# end</pre>	<p>Exits to privileged EXEC mode.</p>

Configuring Conferencing Options for a Phone

DETAILED STEPS

	Command or Action	Purpose
Step 1	enable Example: Router> enable	Enables privileged EXEC mode. <ul style="list-style-type: none"> Enter your password if prompted.
Step 2	configure terminal Example: Router# configure terminal	Enters global configuration mode.
Step 3	ephone-template <i>template-tag</i> Example: Router(config)# ephone-template 1	Enter ephone-template configuration mode to create an ephone template to configure a set of phone features.
Step 4	conference add-mode [creator] Example: Router(config-ephone-template)# conference add-mode creator	(Optional) Configures the mode for adding parties to conferences. <ul style="list-style-type: none"> creator—Only the creator can add parties to the conference.
Step 5	conference drop-mode [creator local] Example: Router(config-ephone-template)# conference drop-mode creator	(Optional) Configures the mode for dropping parties from multi-party ad hoc and meet-me conferences. <ul style="list-style-type: none"> creator—The active conference terminates when the creator hangs up. local—The active conference terminates when the last local party in the conference hangs up or drops out of the conference.
Step 6	conference admin Example: Router(config-ephone-template)# conference admin	(Optional) Configures the ephone as the conference administrator. The administrator can: <ul style="list-style-type: none"> Dial in to any conference directly through the conference number Use the ConfList soft key to list conference parties Remove any party from any conference

Step 7	<p>softkeys connected [Acct] [ConfList] [Confrn] [Endcall] [Flash] [HLog] [Hold] [Join] [Park] [RmLstC] [Select] [Trnsfer]</p> <p>Example:</p> <pre>Router(config-ephone-template)# softkeys connected Hold Trnsfer Park Endcall Confrn ConfList Join Select RmLstC</pre>	<p>Configures an ephone template for soft-key display during the connected call stage.</p> <ul style="list-style-type: none"> The soft keys added are RmLstC, ConfList, Join, and Select. The number and order of soft key keywords you enter in this command correspond to the number and order of soft keys on your phone.
Step 8	<p>softkeys hold [Join] [Newcall] [Resume] [Select]</p> <p>Example:</p> <pre>Router(config-ephone-template)# softkeys hold Join Newcall Resume Select</pre>	<p>Configures an ephone template to modify soft-key display during the call-hold call stage.</p> <ul style="list-style-type: none"> The soft keys added are Join and Select. The number and order of soft key keywords you enter in this command correspond to the number and order of soft keys on your phone.
Step 9	<p>softkeys idle [Cfwdall] [ConfList] [Dnd] [Gpickup] [HLog] [Join] [Login] [Newcall] [Pickup] [Redial] [RmLstC]</p> <p>Example:</p> <pre>Router(config-ephone-template)# softkeys idle ConfList Gpickup Join Login Newcall Pickup Redial RmLstC</pre>	<p>Configures an ephone template for soft-key display during the idle call stage.</p> <ul style="list-style-type: none"> The soft keys added for multi-party conferencing are RmLstC, ConfList, and Join. The number and order of soft key keywords you enter in this command correspond to the number and order of soft keys on your phone.
Step 10	<p>softkeys seized [CallBack] [Cfwdall] [Endcall] [Gpickup] [HLog] [MeetMe] [Pickup] [Redial]</p> <p>Example:</p> <pre>Router(config-ephone-template)# softkeys seized Redial Endcall Cfwdall Pickup Gpickup Callback Meetme</pre>	<p>(Optional) Configures an ephone template for soft-key display during the seized call stage.</p> <ul style="list-style-type: none"> You must configure the MeetMe soft key in the seized state for the ephone to initiate a meet-me conference. The number and order of soft key keywords you enter in this command correspond to the number and order of soft keys on your phone.
Step 11	<p>exit</p> <p>Example:</p> <pre>Router(config-ephone-template)# exit</pre>	<p>Exits ephone-template configuration mode.</p>

Step 12	<code>ephone <i>phone-tag</i></code> Example: <code>Router(config)# ephone 1</code>	Enters Ethernet phone (ephone) configuration mode for an IP phone for the purposes of creating and configuring an ephone.
Step 13	<code>ephone-template <i>template-tag</i></code> Example: <code>Router(config-ephone)# ephone-dn-template 1</code>	Applies an ephone-dn template to an ephone-dn. Note The <i>template-tag</i> must be the same as the <i>template-tag</i> in Step 3.
Step 14	<code>end</code> Example: <code>Router(config-ephone)# exit</code>	Exits to privileged EXEC mode.

APPENDIX C

Transfer to Voice Mail Setup

Introduction

This section provides a sample configuration for enabling direct transfer to CUE/Voicemail of a user by dialing a speed-dial code. The document details how a speed-dial can be created to setup a call to a CUE AA and then send digits for identifying a voicemail mailbox.

The sample demonstrates the ease with which Cisco CallManager Express can integrate with Cisco Unity Express to offer fast access to a user's voicemail instead of going through ringback and then hearing a user's voicemail prompt. This configuration would be especially useful when a receptionist monitors phones and knows that the phone is busy and needs to transfer the caller directly to voicemail.

Components Used

The information in this document is based on the following software and Cisco 2821 router hardware:

- Cisco 2821 ISR router with CallManager Express 4.0 for call processing
- Cisco IOS IP Voice feature set
- NM-CUE with 2.1.3 version software to provide AA services
- VIC2-4FXO to connect analog PSTN lines
- HWICD-9ESW with inline power card to provide LAN switching and inline power for maximum of 8 IP Phones

The information presented in this section was created from devices in a specific lab environment. All of the devices used in this document started with a cleared (default) configuration. If you are working in a live network, ensure that you understand the potential impact of any command before using it.

Related Products

This configuration can also be used with any Cisco 2800 and Cisco 3800 Series routers.

Configure

In this section, you are presented with the information to configure the features described in this document.

Note To find additional information on the commands used in this document, use the Cisco IOS Command Lookup tool. You must have an account on Cisco.com. If you do not have an account or have forgotten your username or password, click Cancel at the login dialog box and follow the instructions that appear.

Configuration Tips:

- Routing should be enabled and assumed to be configured.

- The external flash card on the integrated services routers holds the router image, VLAN database, graphical user interface (GUI) files for Cisco CME and Cisco Unity Express. It should not be removed during the normal operation of the router.

Network

The network contains a CME router with an NM-CUE. IP Phones are connected to the HWICD-9ESW and analog line is connected to VIC2-4FXO.

Dial plan

Before configuring CME and CUE, you should plan your dial plan for CME IP phones, CUE and bulk speed-dial on CME. The following is a sample of numbers that need to be defined before configuring the system.

Name	Number	Description
IP Phones (with Voicemail)	1001, 1002, 1003	Ephone-dn numbers of IP phones that have a voicemail mailbox.
Bulk speed-dial prefix	#	Bulk speed-dial prefix is used to access bulk speed-dial numbers. # is default but this can be changed to * or #/* followed by other numbers.
Bulk speed-dial file for direct access to VM	0	This is the reference to a file that contains entries for bulk speed-dial codes. This is used in conjunction with bulk speed-dial prefix and list entry to address a particular number
Bulk speed-dial entries	1,2,3	Each speed-dial is referred to by an entry. This is used in conjunction with bulk speed-dial prefix and file reference to refer to a particular number. In this example, 1 would refer to 1001, 2 to 1002, 3 to 1003.
CUE AA pilot for direct transfer to VM script	6500	Trigger on CUE for direct transfer to VM script.

Configuration – Router

!

```
voice service voip
allow-connections h323 to sip
!
interface Service-Engine1/0
 ip address 20.20.20.21 255.255.255.0
 service-module ip address 20.20.20.20 255.255.255.0
 service-module ip default-gateway 20.20.20.21
!
ip classless
ip route 20.20.20.20 255.255.255.255 Service-Engine1/0
!
tftp-server flash:speed-dial-test.txt
!
dial-peer voice 6000 voip
 destination-pattern 6...
 session protocol sipv2
 session target ipv4:20.20.20.20
 codec g711ulaw
 no vad
!
telephony-service
 max-ephones 24
 max-dn 48
 ip source-address 20.20.20.21 port 2000
 bulk-speed-dial list 0 flash:speed-dial-vm.txt
 voicemail 6000
 max-conferences 12 gain -6
 web admin system name cisco password cisco
 dn-webedit
 time-webedit
 transfer-system full-consult
 transfer-pattern .....
 transfer-pattern ....
 create cnf-files version-stamp Jan 01 2002 00:00:00
!
ephone-dn 1 dual-line
 number 1001 secondary 4085551001
 label Adam
 name Adam
 call-forward busy 6000
 call-forward noan 6000 timeout 10
 hold-alert 30 originator
!
!
ephone-dn 2 dual-line
 number 1002 secondary 4085551002
 label Bob
 name Bob
 call-forward busy 6000
 call-forward noan 6000 timeout 10
```

```
hold-alert 30 originator
!
!
ephone-dn 3 dual-line
number 1003 secondary 4085551003
label Charlie
name Charlie
call-forward busy 6000
call-forward noan 6000 timeout 10
hold-alert 30 originator
!
!
ephone-dn 47
number 8000....
mwi on
!
!
ephone-dn 48
number 8001....
mwi off
!
!
ephone 1
mac-address 0012.0080.0A30
type 7960
button 1:1
!
ephone 2
mac-address 0002.B9AF.C7A6
type 7960
button 1:2
!
ephone 3
mac-address 0030.94C4.05E6
button 1:3
!
End
```

Configuration – CUE

Before configuring the following, copy xfer.aef on to CUE. Use the “ccn copy script command on CUE. For instructions refer to http://www.cisco.com/en/US/partner/products/sw/voicesw/ps5520/products_command_reference_chapter09186a00803e98a6_4container_ccmigration_09186a00805e4fd6.html#wp1257299

```
username adam create
username bob create
username charlie create
username adam phonenumberE164 "4085551001"
```

```
username bob phonenumberE164 "4085551002"
username charlie phonenumberE164 "4085551003"
username adam phonenumber "1001"
username bob phonenumber "1002"
username charlie phonenumber "1003"

ccn application ciscoMWIapplication
description "ciscoMWIapplication"
enabled
maxsessions 4
script "setmwi.aef"
parameter "strMWI_OFF_DN" "8001"
parameter "strMWI_ON_DN" "8000"
parameter "CallControlGroupID" "0"
end application

ccn application voicemail
description "voicemail"
enabled
maxsessions 4
script "voicebrowser.aef"
parameter "logoutUri"
"http://localhost/voicemail/vxmlscripts/mbxLogout.jsp"
parameter "uri"
"http://localhost/voicemail/vxmlscripts/login.vxml"
end application

ccn application xfer
description "xfer"
enabled
maxsessions 4
script "xfer.aef"
end application

ccn subsystem sip
gateway address "20.20.20.21"
end subsystem

ccn trigger sip phonenumber 6000
application "voicemail"
enabled
maxsessions 4
end trigger

ccn trigger sip phonenumber 6500
application "xfer"
enabled
maxsessions 4
end trigger
```

end

Configuration – Bulk Speed-dial file

```
1, "6500,1001#", Adams VM, no, no
2, "6500,1002#", Bobs VM, no, no
3, "6500,1003#", Charlies VM, no, no
```

At this point, all required configs are in place to make and transfer calls directly to voicemail using a bulk speed-dial.

Verify

In order to verify the functionality, after the system is configured, dial #01 on any CME phone. This should take you to Adam's voicemail greeting. Similarly, making a call to #02 should take you to Bob's greeting. This tests basic functioning of the setup. If this does not work, follow steps below to see that the system is setup correctly.

This section provides instructions to confirm that your configuration works properly.

```
CCME#sh telephony-service
CONFIG (Version=4.0(0))
=====
Version 4.0(0)
Cisco CallManager Express
For on-line documentation please see:
www.cisco.com/univercd/cc/td/doc/product/access/ip_ph/ip_ks/index.
htm
```

```
ip source-address 20.20.20.21 port 2000
max-ephones 24
max-dn 48
max-conferences 12 gain -6
dspfarm units 0
dspfarm transcode sessions 0
hunt-group report delay 1 hours
hunt-group logout DND
max-redirect 5
voicemail 6000
cnf-file location: system:
cnf-file option: PER-PHONE-TYPE
network-locale[0] US (This is the default network locale for
this box)
network-locale[1] US
network-locale[2] US
network-locale[3] US
network-locale[4] US
user-locale[0] US (This is the default user locale for this box)
user-locale[1] US
```

```

user-locale[2] US
user-locale[3] US
user-locale[4] US
srst mode auto-provision is OFF
srst ephone template is 0
srst dn template is 0
srst dn line mode is single
time-format 12
date-format mm-dd-yy
timezone 0 Greenwich Standard Time
no call-forward pattern is configured.
transfer-pattern ...
transfer-pattern .....
transfer-pattern ....
keepalive 30
timeout interdigit 10
timeout busy 10
timeout ringing 180
caller-id name-only: enable
web admin system name cisco password cisco
web admin customer name Customer
edit DN through Web: enabled.
edit TIME through web: enabled.
Log (table parameters):
    max-size: 150
    retain-timer: 15
create cnf-files version-stamp Jan 01 2002 00:00:00
transfer-system full-consult
local directory service: enabled.

```

CCME#

```

CCME#sh telephony-service bulk-speed-dial summary
      List-id  Entries  Size      Reference  url
          0         2      192      Global    flash:speed-dial-
test.txt
          2         2      192      Global    flash:speed2.txt
2 Global List(s) 0 Local List(s)

```

```

CCME#sh telephony-service bulk-speed-dial global 2 1
=== Complete index search #21 ==
      1         6500,1001#           Adams VM           no
no

```

CCME#

```
CUE> sh ccn application
```

Name: ciscoapplication
 Description: ciscoapplication
 Script: setmwi.aef
 ID number: 0
 Enabled: yes
 Maximum number of sessions: 8
 strMWI_OFF_DN: 8001
 strMWI_ON_DN: 8000
 CallControlGroupID: 0

Name: voicemail
 Description: voicemail
 Script: voicebrowser.aef
 ID number: 1
 Enabled: yes
 Maximum number of sessions: 8
 logoutUri:
 http://localhost/voicemail/vxmlscripts/m
 bxLogout.jsp
 uri:
 http://localhost/voicemail/vxmlscripts/l
 ogin.vxml

Name: autoattendant
 Description: autoattendant
 Script: aa.aef
 ID number: 2
 Enabled: yes
 Maximum number of sessions: 8
 busOpenPrompt: AABusinessOpen.wav
 holidayPrompt: AAHolidayPrompt.wav
 busClosedPrompt: AABusinessClosed.wav
 allowExternalTransfers: false
 MaxRetry: 3
 operExtn: 0
 welcomePrompt: AAWelcome.wav
 businessSchedule: systemschedule

Name: promptmgmt
 Description: promptmgmt
 Script: promptmgmt.aef
 ID number: 3
 Enabled: yes
 Maximum number of sessions: 1

Name: xfer
 Description: xfer
 Script: xfer.aef
 ID number: 4
 Enabled: yes

```
Maximum number of sessions:      8
S2_FaxInfo:                      AABusinessClosed.wav
S2_OfficeDir:                    AABusinessClosed.wav
User3:                           4003
S2_MainMenu:                    AABusinessClosed.wav
User1:                           4001
S2_LocationInfo:                AABusinessClosed.wav
CUE>
CUE> sh ccn trigger
```

```
Name:                            6000
Type:                            SIP
Application:                     voicemail
Locale:                          systemDefault
Idle Timeout:                    10000
Enabled:                         yes
Maximum number of sessions:      8
```

```
Name:                            6100
Type:                            SIP
Application:                     autoattendant
Locale:                          systemDefault
Idle Timeout:                    10000
Enabled:                         yes
Maximum number of sessions:      8
```

```
Name:                            6200
Type:                            SIP
Application:                     promptmgmt
Locale:                          systemDefault
Idle Timeout:                    10000
Enabled:                         yes
Maximum number of sessions:      1
```

```
Name:                            6500
Type:                            SIP
Application:                     xfer
Locale:                          systemDefault
Idle Timeout:                    10000
Enabled:                         yes
Maximum number of sessions:      8
CUE>
```

