









Cisco Prisma II Quad EDR Receiver Installation Guide

For Your Safety

Explanation of Warning and Caution Icons

Avoid personal injury and product damage! Do not proceed beyond any symbol until you fully understand the indicated conditions.

The following warning and caution icons alert you to important information about the safe operation of this product:

-  You may find this symbol in the document that accompanies this product. This symbol indicates important operating or maintenance instructions.
-  You may find this symbol affixed to the product. This symbol indicates a live terminal where a dangerous voltage may be present; the tip of the flash points to the terminal device.
-  You may find this symbol affixed to the product. This symbol indicates a protective ground terminal.
-  You may find this symbol affixed to the product. This symbol indicates a chassis terminal (normally used for equipotential bonding).
-  You may find this symbol affixed to the product. This symbol warns of a potentially hot surface.
-  You may find this symbol affixed to the product and in this document. This symbol indicates an infrared laser that transmits intensity-modulated light and emits invisible laser radiation or an LED that transmits intensity-modulated light.

Important

Please read this entire guide. If this guide provides installation or operation instructions, give particular attention to all safety statements included in this guide.

Notices

Trademark Acknowledgments

Cisco and the Cisco logo are trademarks or registered trademarks of Cisco and/or its affiliates in the U.S. and other countries. To view a list of Cisco trademarks, go to this URL: www.cisco.com/go/trademarks.

Third party trademarks mentioned are the property of their respective owners.

The use of the word partner does not imply a partnership relationship between Cisco and any other company. (1110R)

Publication Disclaimer

Cisco Systems, Inc. assumes no responsibility for errors or omissions that may appear in this publication. We reserve the right to change this publication at any time without notice. This document is not to be construed as conferring by implication, estoppel, or otherwise any license or right under any copyright or patent, whether or not the use of any information in this document employs an invention claimed in any existing or later issued patent.

Copyright

© 2016 Cisco and/or its affiliates. All rights reserved. Printed in the United States of America.

Information in this publication is subject to change without notice. No part of this publication may be reproduced or transmitted in any form, by photocopy, microfilm, xerography, or any other means, or incorporated into any information retrieval system, electronic or mechanical, for any purpose, without the express permission of Cisco Systems, Inc.

Contents

Important Safety Instructions	ix
Safe Operation for Software Controlling Optical Transmission Equipment	xx
Warning Labels	xxi
Module Introduction	22
Receiver Description.....	25
Receiver Overview.....	25
Receiver Features	25
Receiver Operation	25
Receiver Operating Modes	29
Receiver Optical Input	37
Laser Warning.....	37
Receiver Block Diagram.....	28
Receiver Front and Back Panel.....	38
Receiver Illustration (Front and Back)	38
Receiver Front Panel Features.....	39
Back Panel Connectors	40
Host Module	41
Host Module Features	41
Host Module Illustration	42
Host Module Back Panel Connectors.....	43
Module Configuration.....	44
Configuration and Monitoring Methods.....	44
Configuration Summary	45
Module Installation	47
Preparing for Installation.....	48
Unpacking and Inspecting the Module	48
Equipment and Tools Needed	48
Site Requirements	49
Access Requirements.....	49
Equipment Rack.....	49

Contents

Operating Environment	49
Power Requirements	50
Space Requirements.....	50
Prisma II Standard Chassis Style	51
Prisma II XD Chassis Style	53
Connecting the RF Cables to the Chassis	54
To Connect RF Cables for Each Module	54
Installing the Module in the Chassis.....	56
To Install the Receiver Modules in the Host Module	56
To Install the Module in the Chassis.....	58
To Install the Module in a Prisma II XD Chassis.....	59
Cleaning Optical Connectors	61
Recommended Equipment	61
Tips for Optimal Fiber Optic Connector Performance	61
To Clean Optical Connectors	62
Connecting Optical Cables	63
Cable Routing - Prisma II Chassis	63
Cable Routing - Prisma XD Chassis	64
To Connect Optical Cables to Module	65
Connecting the ICIM to Additional Chassis	67
ICIM IN and ICIM OUT Connectors.....	67
ICIM IN and ICIM OUT Cables.....	67
To Connect Chassis-to-Chassis ICIM IN and ICIM OUT Ports	68
Configuring Redundancy	69
External Alarm Connections	69
ALARMS IN and ALARMS OUT Connectors.....	70
ALARMS IN and ALARMS OUT Connector Illustration.....	71
Master/Slave Illustration.....	72
Redundancy Interface Panel.....	72
Prisma II Redundancy Interface Panel Illustrations	73
Operation using ICIM	75
ICIM Introduction.....	77
Laser Warning	77
ICIM Function	77
ICIM Block Diagram.....	78
ICIM2 Front Panel.....	79
ICIM2 Illustration (Front Panel)	79
ICIM2 Front Panel Features.....	80
ICIM LCD.....	80
ICIM MAIN Menu Illustration	80

ICIM Keypad	81
ICIM Password.....	82
Password Protection System	82
To Access the Password Menu.....	83
Expired Password or Inactive Password Messages	83
To Enter the User Password	84
To Change the User Password	85
To Disable the User Password using ICIM	86
Operating the ICIM	88
Using the ICIM.....	88
To Access the ICIM LCD Contrast	88
ICIM MAIN Menu	88
ICIM MAIN Menu Illustration	89
Prisma II ICIM Menu.....	89
Prisma II MAIN Menu and ICIM Menu Structure.....	90
Receiver Software Menu Structure	91
Checking the Operating Status using the ICIM.....	94
To Check the Operating Status using ICIM	94
STATUS Menus.....	95
Configuring the Module using the ICIM.....	96
To Configure Parameters using the ICIM	96
Alarm Threshold Menus.....	97
CONFIG Menus	97
Checking Alarms using the ICIM.....	99
To Check Alarms using ICIM	99
ALARMS Menus	101
To Set Adjustable Alarm Thresholds using the ICIM.....	102
Checking Manufacturing Data using the ICIM	103
To Check Manufacturing Data.....	103
MFG. DATA Menus	104
Saving the Configuration using the ICIM	105
To Save the Current Configuration.....	105
Configuration Complete	105
Adjusting Alarm Thresholds.....	106
To Adjust Alarm Thresholds.....	106
Operation using LCI	107
LCI Introduction	108
LCI Function.....	108
System Requirements.....	109
Computer Requirements.....	109

Contents

Cable Requirements.....	109
Installing LCI.....	110
To Install the LCI Software.....	110
Connecting Your Computer to the Chassis.....	114
To Connect a Computer to the Chassis.....	114
Starting LCI Software.....	116
To Start LCI Software.....	116
LCI Module Tree.....	118
Module Tree.....	118
Accessing the Module Detail Information.....	119
Module Details Window.....	119
To Access the Module Details, Right-Click the Module.....	121
Checking the Operating Status.....	122
To Check Operating Status using LCI.....	122
Configuring the Module using LCI.....	124
To Configure Parameters using LCI.....	124
Checking the Module Alarms using LCI.....	126
To Check Alarms using LCI.....	127
Modifying Module Alarm Limits using LCI.....	128
To Modify Alarm Limits using LCI.....	128
Checking Manufacturing Data using LCI.....	130
To Check Manufacturing Data using LCI.....	130
Maintenance and Troubleshooting.....	131
Maintenance.....	132
Maintenance Record.....	132
General Troubleshooting Information.....	133
Equipment Needed.....	133
Additional Assistance.....	133
Troubleshooting.....	133
Troubleshooting Alarm Conditions.....	134
Module Alarm Conditions.....	134
Customer Information.....	139
Appendix A Module Parameter Descriptions.....	141
Receiver Parameters for GS7000 Nodes.....	142
Operating Status Parameters.....	142
Control Parameters.....	144
Alarm Parameters.....	148

Manufacturing Data Parameters	150
Receiver Parameters for Compact Nodes.....	151
Operating Status Parameters.....	151
Control Parameters.....	154
Alarm Parameters	158
Manufacturing Data Parameters	159
Receiver Parameters for GainMaker Nodes.....	160
Operating Status Parameters.....	160
Control Parameters.....	162
Alarm Parameters	165
Manufacturing Data Parameters	166

Glossary	167
-----------------	------------

Index	173
--------------	------------

Important Safety Instructions

Read and Retain Instructions

Carefully read all safety and operating instructions before operating this equipment, and retain them for future reference.

Follow Instructions and Heed Warnings

Follow all operating and use instructions. Pay attention to all warnings and cautions in the operating instructions, as well as those that are affixed to this equipment.

Terminology

The terms defined below are used in this document. The definitions given are based on those found in safety standards.

Service Personnel - The term *service personnel* applies to trained and qualified individuals who are allowed to install, replace, or service electrical equipment. The service personnel are expected to use their experience and technical skills to avoid possible injury to themselves and others due to hazards that exist in service and restricted access areas.

User and Operator - The terms *user* and *operator* apply to persons other than service personnel.

Ground(ing) and Earth(ing) - The terms *ground(ing)* and *earth(ing)* are synonymous. This document uses *ground(ing)* for clarity, but it can be interpreted as having the same meaning as *earth(ing)*.

Electric Shock Hazard

This equipment meets applicable safety standards.



WARNING:

To reduce risk of electric shock, perform only the instructions that are included in the operating instructions. Refer all servicing to qualified service personnel only.

Electric shock can cause personal injury or even death. Avoid direct contact with dangerous voltages at all times. The protective ground connection, where provided,

Important Safety Instructions

is essential to safe operation and must be verified before connecting the power supply.

Know the following safety warnings and guidelines:

- **Dangerous Voltages**
 - Only qualified service personnel are allowed to perform equipment installation or replacement.
 - Only qualified service personnel are allowed to remove chassis covers and access any of the components inside the chassis.
- **Grounding**
 - Do not violate the protective grounding by using an extension cable, power cable, or autotransformer without a protective ground conductor.
 - Take care to maintain the protective grounding of this equipment during service or repair and to re-establish the protective grounding before putting this equipment back into operation.

Installation Site

When selecting the installation site, comply with the following:

- **Protective Ground** - The protective ground lead of the building's electrical installation should comply with national and local requirements.
- **Environmental Condition** - The installation site should be dry, clean, and ventilated. Do not use this equipment where it could be at risk of contact with water. Ensure that this equipment is operated in an environment that meets the requirements as stated in this equipment's technical specifications, which may be found on this equipment's data sheet.

Installation Requirements



WARNING:

Allow only qualified service personnel to install this equipment. The installation must conform to all local codes and regulations.

Equipment Placement



WARNING:

Avoid personal injury and damage to this equipment. An unstable mounting surface may cause this equipment to fall.

To protect against equipment damage or injury to personnel, comply with the following:

- Install this equipment in a restricted access location.
- Do not install near any heat sources such as radiators, heat registers, stoves, or other equipment (including amplifiers) that produce heat.
- Place this equipment close enough to a mains AC outlet to accommodate the length of this equipment's power cord.
- Route all power cords so that people cannot walk on, place objects on, or lean objects against them. This may pinch or damage the power cords. Pay particular attention to power cords at plugs, outlets, and the points where the power cords exit this equipment.
- Use only with a cart, stand, tripod, bracket, or table specified by the manufacturer, or sold with this equipment.
- Make sure the mounting surface or rack is stable and can support the size and weight of this equipment.
- The mounting surface or rack should be appropriately anchored according to manufacturer's specifications. Ensure this equipment is securely fastened to the mounting surface or rack where necessary to protect against damage due to any disturbance and subsequent fall.

Ventilation

This equipment has openings for ventilation to protect it from overheating. To ensure equipment reliability and safe operation, do not block or cover any of the ventilation openings. Install the equipment in accordance with the manufacturer's instructions.

Rack Mounting Safety Precautions

Mechanical Loading

Make sure that the rack is placed on a stable surface. If the rack has stabilizing devices, install these stabilizing devices before mounting any equipment in the rack.



WARNING:

Avoid personal injury and damage to this equipment. Mounting this equipment in the rack should be such that a hazardous condition is not caused due to uneven mechanical loading.

Reduced Airflow

When mounting this equipment in the rack, do not obstruct the cooling airflow through the rack. Be sure to mount the blanking plates to cover unused rack space. Additional components such as combiners and net strips should be mounted at the back of the rack, so that the free airflow is not restricted.



CAUTION:

Installation of this equipment in a rack should be such that the amount of airflow required for safe operation of this equipment is not compromised.

Elevated Operating Ambient Temperature

Only install this equipment in a humidity- and temperature-controlled environment that meets the requirements given in this equipment's technical specifications.



CAUTION:

If installed in a closed or multi-unit rack assembly, the operating ambient temperature of the rack environment may be greater than room ambient temperature. Therefore, install this equipment in an environment compatible with the manufacturer's maximum rated ambient temperature.

Handling Precautions

When moving a cart that contains this equipment, check for any of the following possible hazards:



WARNING:



Avoid personal injury and damage to this equipment! Move any equipment and cart combination with care. Quick stops, excessive force, and uneven surfaces may cause this equipment and cart to overturn.

- Use caution when moving this equipment/cart combination to avoid injury from

tip-over.

- If the cart does not move easily, this condition may indicate obstructions or cables that may need to be disconnected before moving this equipment to another location.
- Avoid quick stops and starts when moving the cart.
- Check for uneven floor surfaces such as cracks or cables and cords.

Grounding

This section provides instructions for verifying that the equipment is properly grounded.

Safety Plugs (USA Only)

This equipment may be equipped with either a 3-terminal (grounding-type) safety plug or a 2-terminal (polarized) safety plug. The wide blade or the third terminal is provided for safety. Do not defeat the safety purpose of the grounding-type or polarized safety plug.

To properly ground this equipment, follow these safety guidelines:

- **Grounding-Type Plug** - For a 3-terminal plug (one terminal on this plug is a protective grounding pin), insert the plug into a grounded mains, 3-terminal outlet.
Note: This plug fits only one way. If this plug cannot be fully inserted into the outlet, contact an electrician to replace the obsolete 3-terminal outlet.
- **Polarized Plug** - For a 2-terminal plug (a polarized plug with one wide blade and one narrow blade), insert the plug into a polarized mains, 2-terminal outlet in which one socket is wider than the other.
Note: If this plug cannot be fully inserted into the outlet, try reversing the plug. If the plug still fails to fit, contact an electrician to replace the obsolete 2-terminal outlet.

Grounding Terminal

If this equipment is equipped with an external grounding terminal, attach one end of an 18-gauge wire (or larger) to the grounding terminal; then, attach the other end of the wire to a ground, such as a grounded equipment rack.

Safety Plugs (European Union)

- **Class I Mains Powered Equipment** – Provided with a 3-terminal AC inlet and

Important Safety Instructions

requires connection to a 3-terminal mains supply outlet via a 3-terminal power cord for proper connection to the protective ground.

Note: The equipotential bonding terminal provided on some equipment is not designed to function as a protective ground connection.

- **Class II Mains Powered Equipment** – Provided with a 2-terminal AC inlet that may be connected by a 2-terminal power cord to the mains supply outlet. No connection to the protective ground is required as this class of equipment is provided with double or reinforced and/or supplementary insulation in addition to the basic insulation provided in Class I equipment.

Note: Class II equipment, which is subject to EN 50083-1, is provided with a chassis mounted equipotential bonding terminal. See the section titled **Equipotential Bonding** for connection instructions.

Equipotential Bonding

If this equipment is equipped with an external chassis terminal marked with the IEC 60417-5020 chassis icon () , the installer should refer to CENELEC standard EN 50083-1 or IEC standard IEC 60728-11 for correct equipotential bonding connection instructions.

AC Power

Important: If this equipment is a Class I equipment, it must be grounded.

- If this equipment plugs into an outlet, the outlet must be near this equipment, and must be easily accessible.
- Connect this equipment only to the power sources that are identified on the equipment-rating label normally located close to the power inlet connector(s).
- This equipment may have two power sources. Be sure to disconnect all power sources before working on this equipment.
- If this equipment **does not** have a main power switch, the power cord connector serves as the disconnect device.
- Always pull on the plug or the connector to disconnect a cable. Never pull on the cable itself.
- Unplug this equipment when unused for long periods of time.

Connection to -48 V DC/-60 V DC Power Sources

If this equipment is DC-powered, refer to the specific installation instructions in this manual or in companion manuals in this series for information on connecting this equipment to nominal -48 V DC/-60 V DC power sources.

Circuit Overload

Know the effects of circuit overloading before connecting this equipment to the power supply.

**CAUTION:**

Consider the connection of this equipment to the supply circuit and the effect that overloading of circuits might have on overcurrent protection and supply wiring. Refer to the information on the equipment-rating label when addressing this concern.

General Servicing Precautions

**WARNING:**

Avoid electric shock! Opening or removing this equipment's cover may expose you to dangerous voltages.

**CAUTION:**

These servicing precautions are for the guidance of qualified service personnel only. To reduce the risk of electric shock, do not perform any servicing other than that contained in the operating instructions unless you are qualified to do so. Refer all servicing to qualified service personnel.

Be aware of the following general precautions and guidelines:

- **Servicing** - Servicing is required when this equipment has been damaged in any way, such as power supply cord or plug is damaged, liquid has been spilled or objects have fallen into this equipment, this equipment has been exposed to rain or moisture, does not operate normally, or has been dropped.
- **Wristwatch and Jewelry** - For personal safety and to avoid damage of this equipment during service and repair, do not wear electrically conducting objects such as a wristwatch or jewelry.
- **Lightning** - Do not work on this equipment, or connect or disconnect cables, during periods of lightning.

Important Safety Instructions

- **Labels** - Do not remove any warning labels. Replace damaged or illegible warning labels with new ones.
- **Covers** - Do not open the cover of this equipment and attempt service unless instructed to do so in the instructions. Refer all servicing to qualified service personnel only.
- **Moisture** - Do not allow moisture to enter this equipment.
- **Cleaning** - Use a damp cloth for cleaning.
- **Safety Checks** - After service, assemble this equipment and perform safety checks to ensure it is safe to use before putting it back into operation.

Electrostatic Discharge

Electrostatic discharge (ESD) results from the static electricity buildup on the human body and other objects. This static discharge can degrade components and cause failures.

Take the following precautions against electrostatic discharge:

- Use an anti-static bench mat and a wrist strap or ankle strap designed to safely ground ESD potentials through a resistive element.
- Keep components in their anti-static packaging until installed.
- Avoid touching electronic components when installing a module.

Fuse Replacement

To replace a fuse, comply with the following:

- Disconnect the power before changing fuses.
- Identify and clear the condition that caused the original fuse failure.
- Always use a fuse of the correct type and rating. The correct type and rating are indicated on this equipment.

Batteries

This product may contain batteries. Special instructions apply regarding the safe use and disposal of batteries:

Safety

- Insert batteries correctly. There may be a risk of explosion if the batteries are incorrectly inserted.

- Do not attempt to recharge 'disposable' or 'non-reusable' batteries.
- Please follow instructions provided for charging 'rechargeable' batteries.
- Replace batteries with the same or equivalent type recommended by manufacturer.
- Do not expose batteries to temperatures above 100°C (212°F).

Disposal

- The batteries may contain substances that could be harmful to the environment
- Recycle or dispose of batteries in accordance with the battery manufacturer's instructions and local/national disposal and recycling regulations.



廢電池請回收

- The batteries may contain perchlorate, a known hazardous substance, so special handling and disposal of this product might be necessary. For more information about perchlorate and best management practices for perchlorate-containing substance, see www.dtsc.ca.gov/hazardouswaste/perchlorate.

Modifications

This equipment has been designed and tested to comply with applicable safety, laser safety, and EMC regulations, codes, and standards to ensure safe operation in its intended environment. Refer to this equipment's data sheet for details about regulatory compliance approvals.

Do not make modifications to this equipment. Any changes or modifications could void the user's authority to operate this equipment.

Modifications have the potential to degrade the level of protection built into this equipment, putting people and property at risk of injury or damage. Those persons making any modifications expose themselves to the penalties arising from proven non-compliance with regulatory requirements and to civil litigation for compensation in respect of consequential damages or injury.

Accessories

Use only attachments or accessories specified by the manufacturer.

Electromagnetic Compatibility Regulatory Requirements

This equipment meets applicable electromagnetic compatibility (EMC) regulatory requirements. Refer to this equipment's data sheet for details about regulatory compliance approvals. EMC performance is dependent upon the use of correctly shielded cables of good quality for all external connections, except the power source, when installing this equipment.

- Ensure compliance with cable/connector specifications and associated installation instructions where given elsewhere in this manual.

Otherwise, comply with the following good practices:

- Multi-conductor cables should be of single-braided, shielded type and have conductive connector bodies and backshells with cable clamps that are conductively bonded to the backshell and capable of making 360° connection to the cable shielding. Exceptions from this general rule will be clearly stated in the connector description for the excepted connector in question.
- Ethernet cables should be of single-shielded or double-shielded type.
- Coaxial cables should be of the double-braided shielded type.

EMC Compliance Statements

Where this equipment is subject to USA FCC and/or Industry Canada rules, the following statements apply:

FCC Statement for Class A Equipment

This equipment has been tested and found to comply with the limits for a Class A digital device, pursuant to Part 15 of the FCC Rules. These limits are designed to provide reasonable protection against harmful interference when this equipment is operated in a commercial environment.

This equipment generates, uses, and can radiate radio frequency energy and, if not installed and used in accordance with the instruction manual, may cause harmful interference to radio communications. Operation of this equipment in a residential

area is likely to cause harmful interference in which case users will be required to correct the interference at their own expense.

Industry Canada - Industrie Canadienne Statement

This apparatus complies with Canadian ICES-003.
Cet appareil est conforme à la norme NMB-003 du Canada.

CENELEC/CISPR Statement with Respect to Class A Information Technology Equipment

This is a Class A equipment. In a domestic environment this equipment may cause radio interference in which case the user may be required to take adequate measures.

Safe Operation for Software Controlling Optical Transmission Equipment

If this manual discusses software, the software described is used to monitor and/or control ours and other vendors' electrical and optical equipment designed to transmit video, voice, or data signals. Certain safety precautions must be observed when operating equipment of this nature.

For equipment specific safety requirements, refer to the appropriate section of the equipment documentation.

For safe operation of this software, refer to the following warnings.



WARNING:

- **Ensure that all optical connections are complete or terminated before using this equipment to remotely control a laser device. An optical or laser device can pose a hazard to remotely located personnel when operated without their knowledge.**
- **Allow only personnel trained in laser safety to operate this software. Otherwise, injuries to personnel may occur.**
- **Restrict access of this software to authorized personnel only.**
- **Install this software in equipment that is located in a restricted access area.**

Warning Labels

The following labels are located on this product.

Laser Warning Label *



Product and Laser Information Label

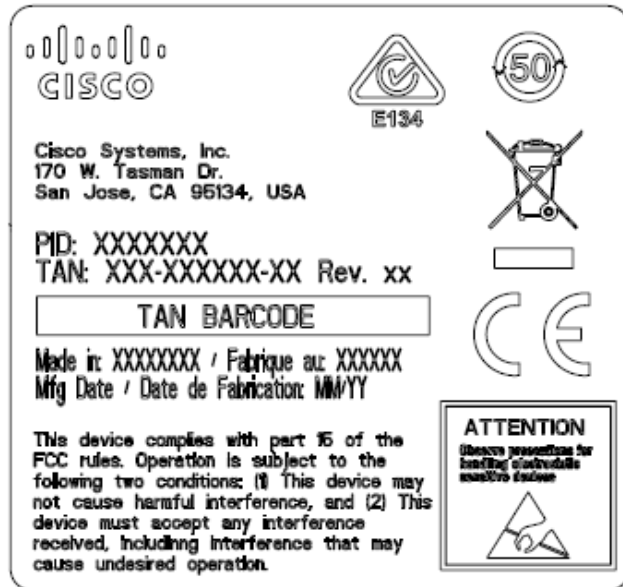

* Located on host module only (not applicable to receiver module).

1

Module Introduction

Overview

This chapter describes the Cisco® Prisma® II Quad Enhanced Digital Return (QEDR) Receiver Module.

Note: This product uses the FreeRTOS real time operating system (v 8.2.1). The source code can be obtained from <http://www.FreeRTOS.org>.

FreeRTOS is a free software; it can be redistributed and/or modified under the terms of the GNU General Public License (version 2) as published by the Free Software Foundation and modified by the FreeRTOS exception which allows distribution of a combined work that includes FreeRTOS, without being obligated to provide the source code for proprietary components outside of the FreeRTOS kernel.

Purpose

This guide provides information about the receiver. This chapter describes the front and back panels, and presents a setup summary for the receiver.

Who Should Use This Document

This document is intended for authorized service personnel who have experience working with similar equipment. The service personnel should have appropriate background and knowledge to complete the procedures described in this document.

Qualified Personnel

Only appropriately qualified and skilled personnel should attempt to install, operate, maintain, and service this product.



WARNING:

Only appropriately qualified and skilled personnel should attempt to install, operate, maintain, and service this product. Otherwise, personal injury or equipment damage may occur.

In This Chapter

■ Receiver Description	25
■ Receiver Front and Back Panel	38
■ Host Module.....	41
■ Module Configuration	44

Scope

This guide discusses the following topics.

- Description of the receiver
- Installation procedures
- Operation using the ICIM
- Operation using LCI
- Maintenance and troubleshooting
- Customer support information
- Module parameter descriptions

Document Version

This is the first release of this guide.

Related Publication

You may find the following publication useful as you implement the procedures in this document.

- *Prisma II Software Upgrade Program (SOUP) Installation Guide*

Receiver Description

Receiver Overview

The Quad EDR Receiver is a plug-in module for the Prisma II and Prisma II XD platforms. These modules are part of the Prisma II optical network, an advanced transmission system designed to optimize network architectures and increase reliability, scalability, and cost-effectiveness.

The receiver module installs into a Prisma II XD Chassis directly, or into a standard Prisma II Chassis by means of a host module that accepts up to two Prisma II High Density application modules.

The receiver front panel contains two optical pluggable module (OPM) connectors that provides inputs for four separate optical receiver circuits. A single test point is selectable between the two receiver outputs for RF output verification.

All connectors are easily accessible. ALARM and Power ON indicators on the front panel allow you to monitor power and alarm status at a glance.

Receiver Features

The receiver has the following key features.

- Front panel green light emitting diodes (LEDs) indicate operating status
- Front panel red LED indicates alarm status
- -20 dB test point on front panel, selectable between output 1 and output 2
- Quad LC/PC optical input connector in OPM
- Plug-and-play capability
- Compatible with Intelligent Communications Interface Module (ICIM or ICIM2), Local Craft Interface (LCI) software, ROSA software, Command Line Interface (CLI) software, and the ICIM Web Interface
- Blind-mate radio frequency (RF) connections on module back panel

Receiver Operation

The Cisco QEDR system is a set of long-haul transport products for CATV reverse path applications. The system is designed to transport analog reverse path spectra

from node to hub or headend over optical fiber. Reverse path signals are typically DOCSIS and DAVIC data.

At the node, one or two analog reverse path signals occupying the 5 - 85 MHz reverse band spectrum are sampled by an analog-to-digital converter (ADC). A high-speed serial data stream is constructed by scrambling and framing the data. This data stream is carried optically over fiber to a remote hub or headend, where the receiver detects the optical signal and converts it back to a serial electrical signal. The data is unpacked and sent to a digital-to-analog converter (DAC), which reconstructs the originally transmitted analog spectrum.

This system consists of an optical transmitter module installed in a GainMaker Node, GS7000 Node, or Compact Node, and an optical receiver module installed in a Prisma II or Prisma XD chassis at the hub or headend.



CAUTION:

The QEDR receiver is designed to work exclusively with EDR transmitters as part of the Cisco EDR system. Results with other transmitters are not guaranteed. Do not install Cisco EDR transmitters in any daisy chain with one or more Cisco QEDR receivers.

Receiver Description

The receiver module contains four separate optoelectronic receiver circuits. Optical input is through an OPM connector mounted on the front of the module. The RF output is through two connectors on the rear of the module.

Each RF output can be attenuated by as much as 10 dB, relative to no attenuation, in 0.5 dB increments. The actual RF output levels of the receiver, attenuated by 20 dB, can be monitored at a selectable test point on the front panel.

The receiver supports 2.5 GHz (1:1) and 5 GHz (2:1) configurations in an XD form factor for both Prisma II (using Host Module) and Prisma XD Chassis. The OPM optical input uses a dual LC/PC connector and supports all standard reverse bandwidths: 40, 42, 55, 65, and 85 MHz.

The receiver can be operated in any of the following operating modes:

- 1:1 Input (2.5 GHz), One RF Output, One OPM
- 1:1 Input (2.5 GHz), One RF Output, Two OPMs
- 1:1 Input (2.5 GHz), Two RF Outputs, One OPM
- 1:1 Input (2.5 GHz), Two RF Output, Two OPMs
- 2:1 Input (5 GHz), One RF Output, One OPM
- 2:1 Input (5 GHz), One RF Output, Two OPMs

- 2:1 Input (5 GHz), Two RF Outputs, One OPM
- 2:1 Input (5 GHz), Two RF Output, Two OPMs

The factory default operating mode is 2:1 Input, One RF Output, Two OPMs; other modes can be selected by the user. For additional details on these operating modes, see *Receiver Operating Modes* (on page 28).

Additionally, the receiver can be operated in any of three redundancy modes: Master, Slave, or Single. When the receiver module is placed in Single operating mode, four receiver channels in the module will continue to operate even if the optical input level falls below the major alarm threshold.

Key operating parameters of the receiver and the transmitter at the node can be controlled and monitored by an ICIM2 or ICIM2-XD, LCI software, ROSA software, CLI commands, or the ICIM Web Interface. See *Module Parameter Descriptions* (on page 141) for details.

Note: Node data is only available for GS7000 Nodes that have a transponder-less LCM installed and an interface cable installed between transmitter and LCM. For details, see the *GS7000 GainMaker Scalable 4-Port Node Installation and Operation Guide*. Some transmitter data is available in all cases.

Receiver Block Diagram

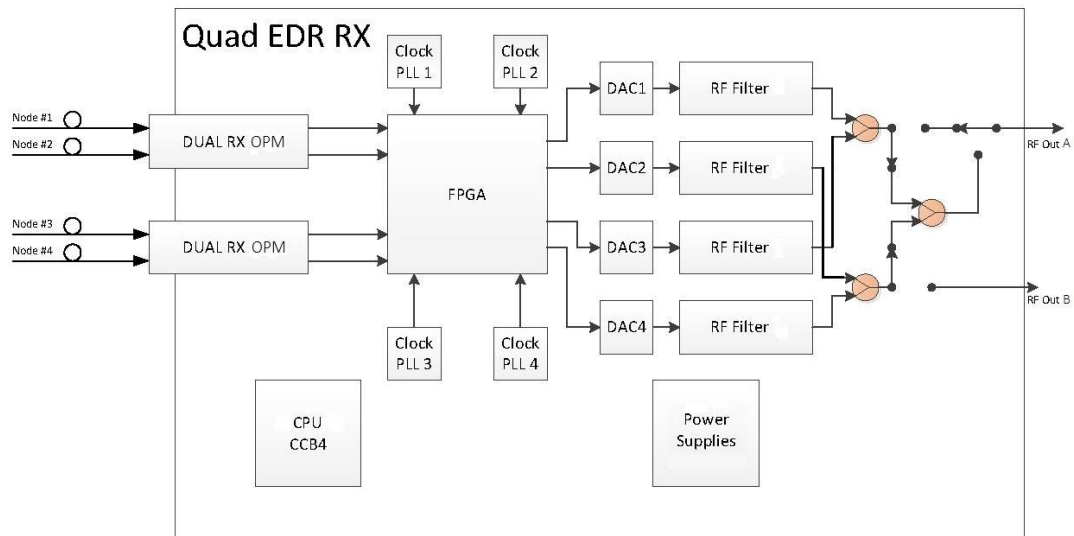

Referring to the block diagram above (or below). The top OPM accepts two optical inputs. The optical signals are converted to digital, unscrambled and converted back to RF by DACs 1 and 3. These signals are then routed to the top RF output (A) through an RF switch network.

Similarly, the bottom OPM accepts two more optical inputs and uses DACs 2 and 4 to convert those signals back to RF. The RF switch network allows this combined signal to be routed to the top RF connector (A) or the bottom RF connector (B).

The switching network on the right side of the block diagram also shows the test point. The test point is fed by a 3 position switch which can pick off output A, output B or neither.

There are four Enable controls (Enable1 – Enable4) that allow one to mute/unmute the individual receiver inputs. These controls actually turn off the DACs.

There are four controls that, in combination with the Rx Mode setting, control the RF signal routing through the switch network. In the 2.5G mode, these essentially act like additional mute controls, but in the 5G mode, they allow control over the two

individual 2.5 G streams within a 5G stream. These controls do not turn off the DACs.

The RF Ports control controls whether just the top RF output port (A) is used or both RF output ports (A and B) are used.

The switching options are discussed in the section below.

Receiver Operating Modes

The receiver can be configured for any of the following modes of operation:

- 1:1 Input, One RF Output, One OPM
- 1:1 Input, One RF Output, Two OPMs
- 1:1 Input, Two RF Outputs, One OPM
- 1:1 Input, Two RF Output, Two OPMs
- 2:1 Input, One RF Output, One OPM
- 2:1 Input, One RF Output, Two OPMs
- 2:1 Input, Two RF Outputs, One OPM
- 2:1 Input, Two RF Output, Two OPMs

Each of these operating modes is described below.

1:1 Input, One RF Output, One OPM

Referring to the diagram below, each QEDR transmitter digitizes a single RF signal into a serial stream and transmits it over optical fiber to the receiver. At the receiver, the serial streams from two separate transmitters are deserialized and converted

back to analog RF signals. The RF signals for transmitter #1 and transmitter #2 are combined and sent to the RF Out Port A on the back of the module.

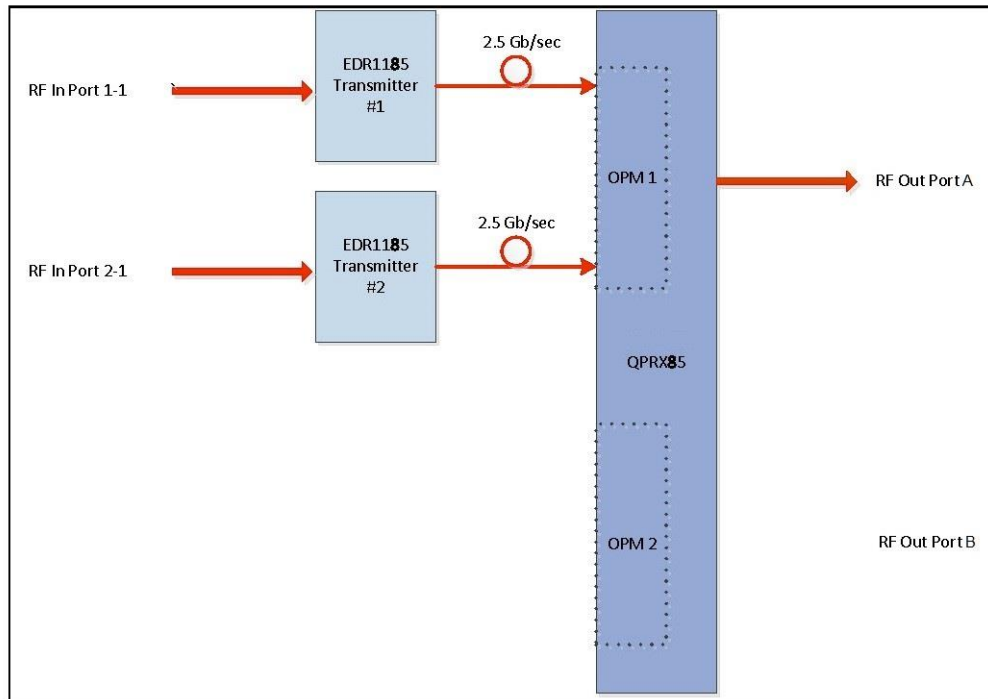

1:1 Input, One RF Output, Two OPMs

Referring to the diagram below, each QEDR transmitter digitizes a single RF signal into a serial stream and transmits it over optical fiber to the receiver. At the receiver, the serial streams from four separate transmitters are deserialized and converted back to analog RF signals. The RF signals for transmitter #1, transmitter #2, transmitter #3 and transmitter #4 are combined and sent to the RF Out Port A on the back of the module.

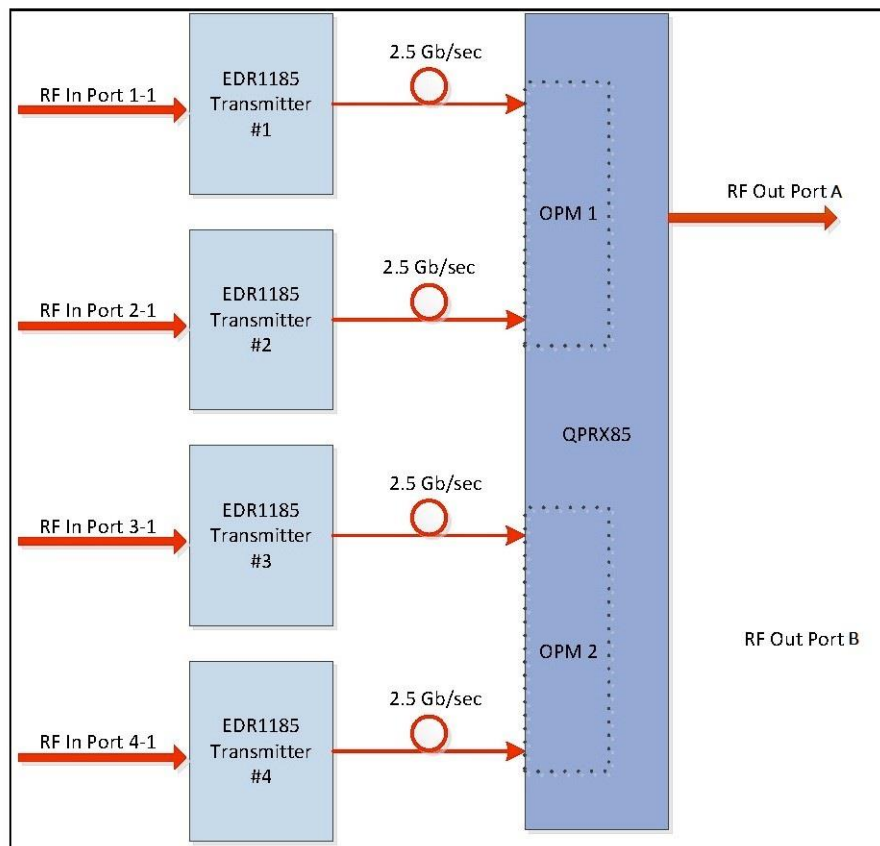

1:1 Input, Two RF Outputs, One OPM

Referring to the diagram below, each QEDR transmitter digitizes a single RF signal into a serial stream and transmits it over optical fiber to the receiver. At the receiver, the serial streams from two separate transmitters are deserialized and converted

back to analog RF signals. The RF signal for transmitter #1 is sent to the RF Out Port A, the RF signal for transmitter #2 is sent to the RF Out Port B.

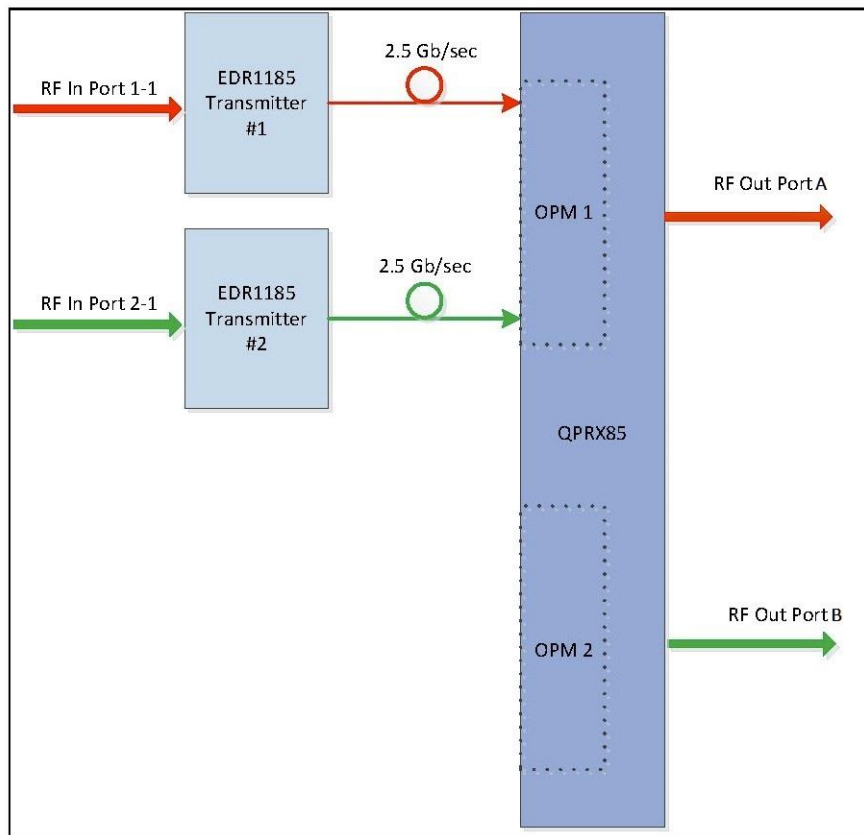

1:1 Input, Two RF Outputs, Two OPMs

Referring to the diagram below, each QEDR transmitter digitizes a single RF signal into a serial stream and transmits it over optical fiber to the receiver. At the receiver, the serial streams from four separate transmitters are deserialized and converted back to analog RF signals. The RF signals for transmitter #1 and transmitter #3 are combined and sent to the RF Out Port A, the RF signals for transmitter #2 and transmitter #4 are combined and sent to the RF Out Port B.

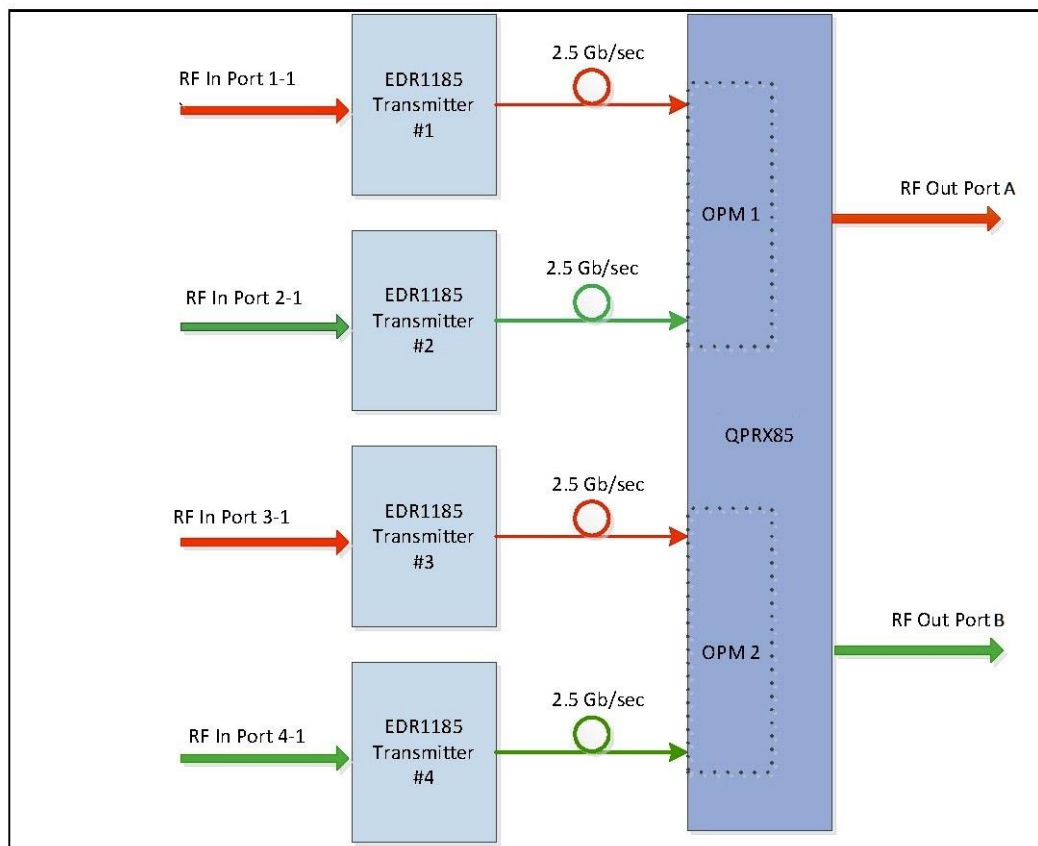

2:1 Input, One RF Output, One OPM

Referring to the diagram below, each QEDR transmitter digitizes two RF signals into a 5 GHz serial stream and transmits it over optical fiber to the receiver. At the receiver, the serial streams from two separate transmitters are deserialized and converted back to analog RF signals. The RF signals for transmitter #1 and

transmitter #2 are combined and sent to the RF Out Port A on the back of the module. Any of the four RF signals on RF Out Port A can be muted.

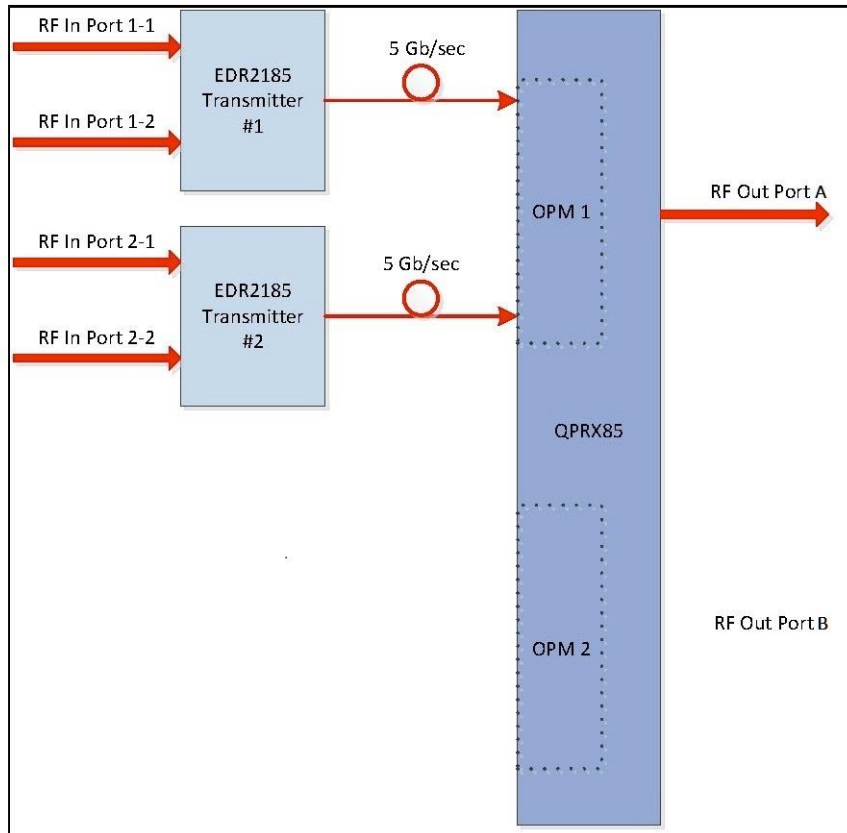

2:1 Input, One RF Output, Two OPMs

Referring to the diagram below, each QEDR transmitter digitizes two RF signals into a serial stream and transmits it over optical fiber to the receiver. At the receiver, the serial streams from four separate transmitters are deserialized and converted back to analog RF signals. The RF signals for transmitter #1, transmitter #2, transmitter #3 and transmitter #4 are combined and sent to the RF Out Port A on the back of the module.

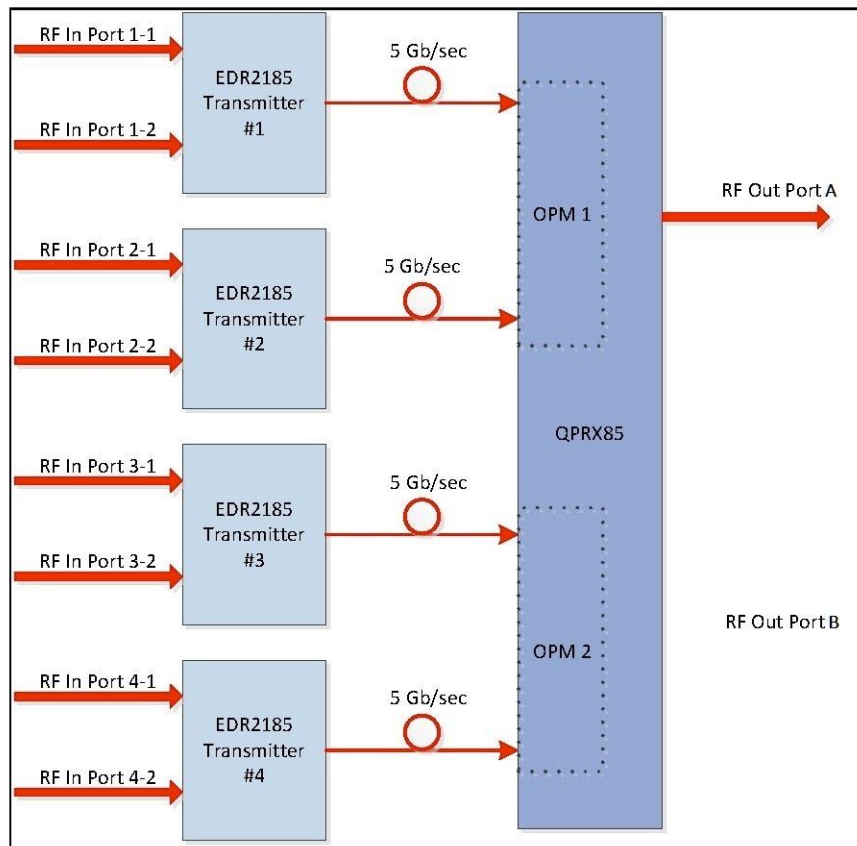

2:1 Input, Two RF Outputs, One OPM

Referring to the diagram below, each QEDR transmitter digitizes two RF signals into a serial stream and transmits it over optical fiber to the receiver. At the receiver, the serial streams from two separate transmitters are deserialized and converted back to

analog RF signals. The RF signals for transmitter #1 are sent to the RF Out Port A, the RF signals for transmitter #2 are sent to the RF Out Port B.

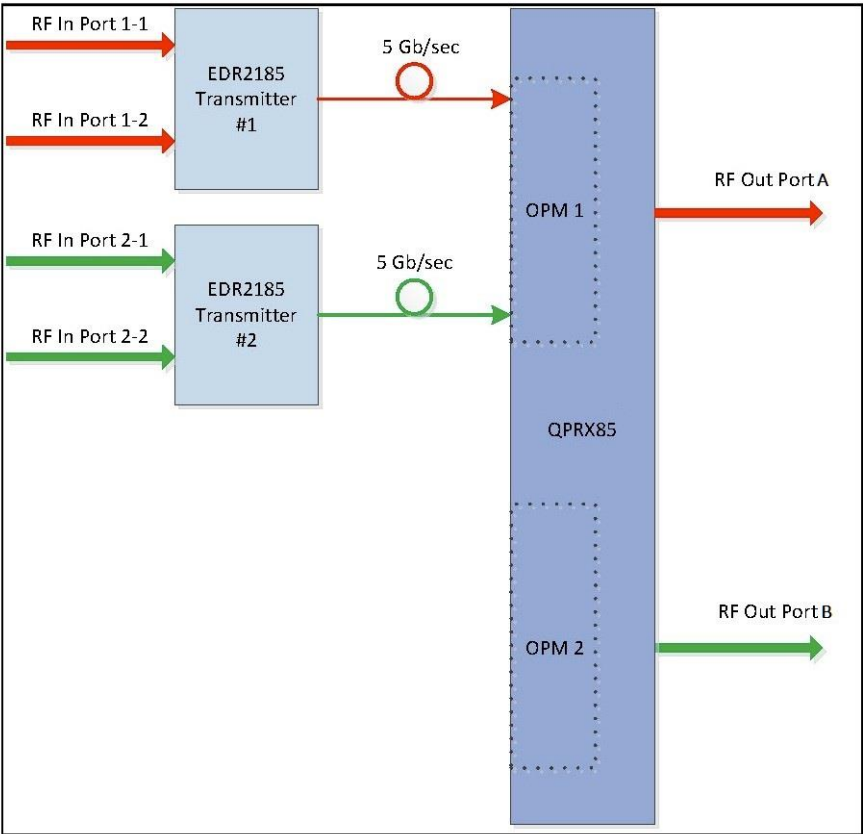

2:1 Input, Two RF Output, Two OPMs

Referring to the diagram below, each QEDR transmitter digitizes two RF signal into a serial stream and transmits it over optical fiber to the receiver. At the receiver, the serial streams from four separate transmitters are deserialized and converted back to analog RF signals. The RF signals for transmitter #1 and transmitter #3 are combined

and sent to the RF Out Port A, the RF signals for transmitter #2 and transmitter #4 are combined and sent to the RF Out Port B.

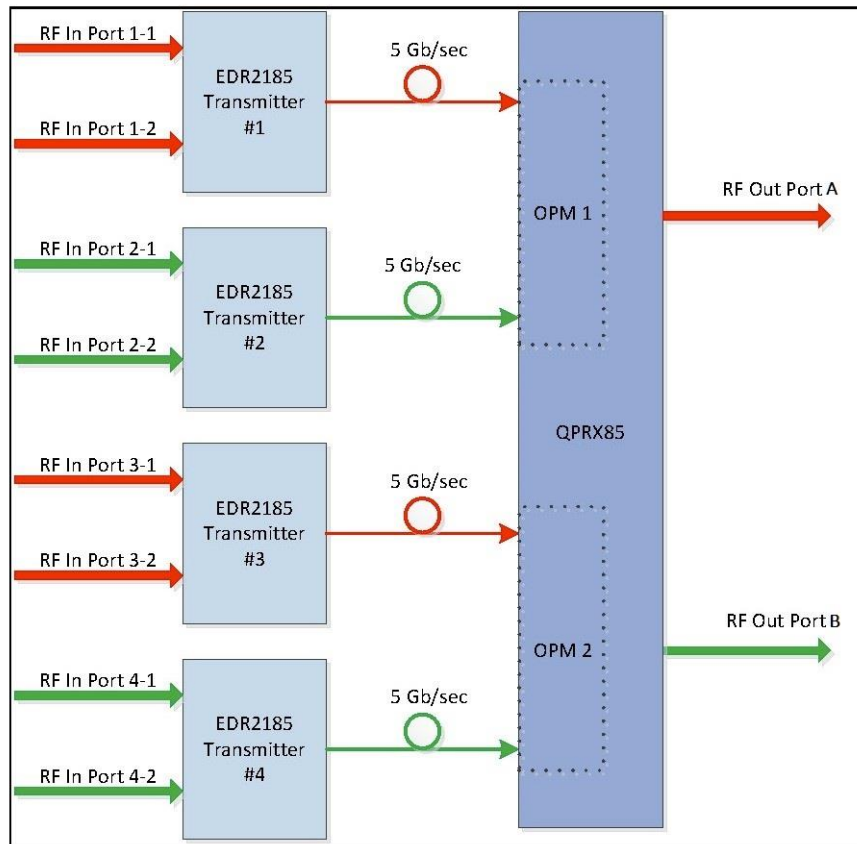

Receiver Optical Input

The optical input is a dual LC/PC connector in an OPM.

Laser Warning



WARNING:

Avoid damage to your eyes! Do not look into any optical connector while the system is active. Even if the unit is off, there may still be hazardous optical levels present.

Receiver Front and Back Panel

Receiver Illustration (Front and Back)

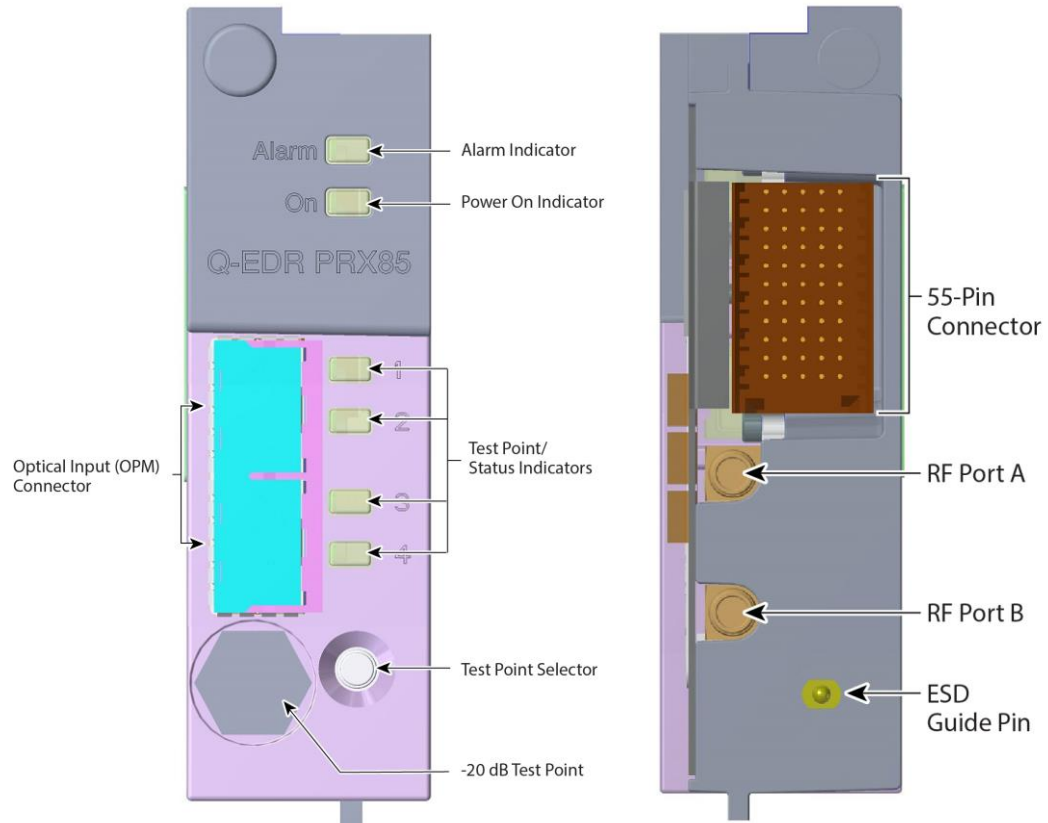

Receiver Front Panel Features

Part	Function					
Alarm Indicator LED	Illuminates or blinks when an alarm condition occurs.					
Power On Indicator LED	Illuminates when power is supplied to the module. <ul style="list-style-type: none"> ■ Glows steadily to indicate Master, Single, or Active Slave operation. ■ Blinks to indicate active Slave operation. 					
Test Point Selector	Switches the -20 dB Test Point between output A, output B, and neither. Operation is dependent on the "RF Ports" setting. If RF Ports is set to 2: <ul style="list-style-type: none"> • Press once to route the output A signal to the test point. • Press again to route the output B signal to the test point; • Press once more for neither. If RF Ports is set to 1 (i.e. all outputs are on output A): <ul style="list-style-type: none"> • Press once to route the output A signal to the test point; Press again for neither.					
-20 dB Test Point	Provides a -20 dB sample of the RF output signal.					
LED 1	Blink	Off	On	On	X	
LED 2	Blink	Off	On	X	On	
LED 3	Blink	Off	On	On	X	
LED 4	Blink	Off	On	X	On	
Test point indication overrides other indications	Invalid data (no data or data with frame or CRC errors)	Normal operation (valid data being received)	Output A RF routed to test point	Output A RF routed to test point*	Output B RF routed to test point*	
Optical Input OPM Connector	Connects the input signal to the optical cable.					

Back Panel Connectors

Blind-mate connectors make it easy to install this module. The push-on connector on the back of the module mates with the back plane bus connector inside the chassis. This 55-pin connector and the two RF connectors provide the following facilities.

- RF signal connections
- Electrical power input connection
- Alarm communications connections
- Status-monitoring communications
- Communications and control connections

The ESD guide pin near the bottom of the back panel serves as both a guide pin and an ESD ground connection. The length of the pin ensures that ground is the first electrical connection made as the module is inserted, and the last connection to be broken as the module is removed.

Host Module

A host module is required to mount the application module in a standard Prisma II Chassis. The host module doubles the density of the Prisma II Chassis by providing two high density module slots for each current Prisma II slot. Its simple design allows for efficient routing of RF and electrical signal between the chassis back plane and each high density module.

Host Module Features

The host module has the following features:

- Provides upper and lower slots for two high density modules
- Incorporates a passive design for high reliability
- Provides for RF and DC routing between the chassis back plane and each high density module

Host Module Illustration

Front View

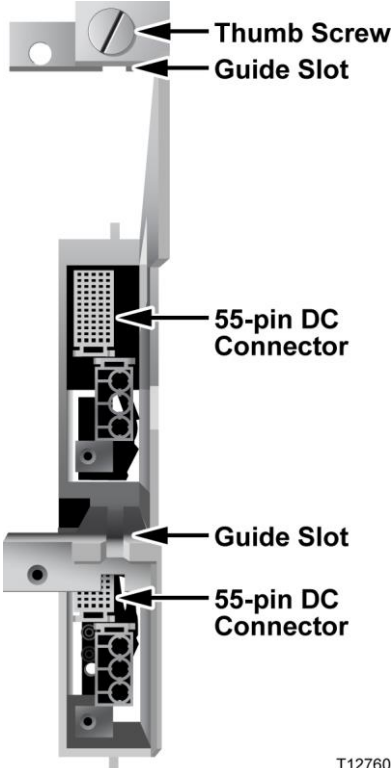

T12760

Back View

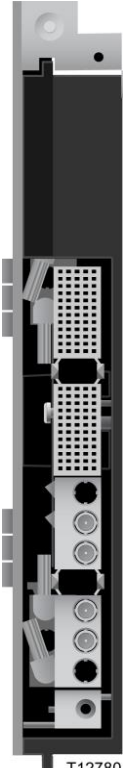

T12780

Side View

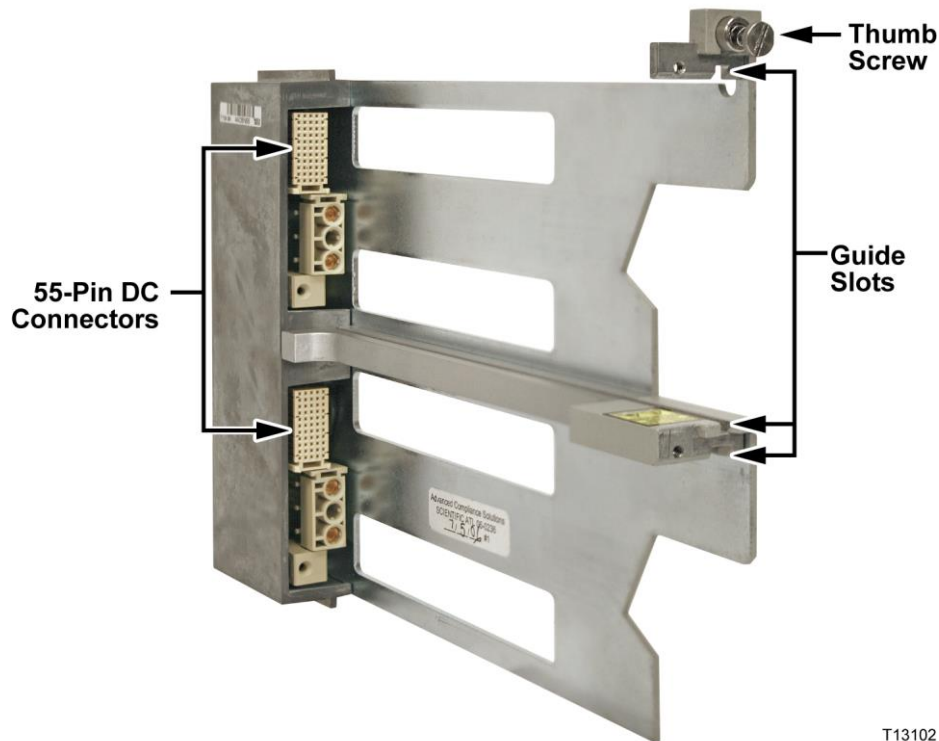

T13102

Host Module Back Panel Connectors

Blind-mate connectors make it easy to install the host module. The push-on connector on the back of the module mates with the back plane bus connector inside the chassis. This 110-pin connector provides the following facilities:

- RF signal input connection
- Electrical power input connection
- Alarm communications connections
- Status-monitoring connections
- Communications and control connections

Module Configuration

The module is shipped from the factory with operational parameters set to factory defaults. However, you will probably choose to configure the operating parameters so that they are best suited for your application.

Configuration and Monitoring Methods

The module may be controlled and monitored using any of the following methods.

- Prisma II ICIM Front Panel

When a standard Intelligent Communications Interface Module 2 (ICIM2) is used, its front-panel LCD and keypad interface can be used to configure and monitor this and other Prisma II modules in the ICIM domain. For instructions on operating this module using this ICIM, refer to *Operation using ICIM* (on page 75).

- LCI Software

Local Craft Interface (LCI) software running on a locally connected PC may be used to configure operating parameters of Prisma II modules. For instructions on operating this module using LCI software, refer to *Operation using LCI* (on page 107).

- CLI Commands

If an ICIM2 or ICIM2-XD is installed, a command line interface (CLI) is available that can be used to configure and monitor all Prisma II modules in the ICIM domain. The CLI is available locally (RS-232) or remotely via Telnet. For details, see the configuration guide for your Prisma II system release.

- ICIM Web Interface

The ICIM Web Interface offers a user-friendly alternative to CLI commands for remote module setup and monitoring using an ICIM2 or ICIM2-XD. Users navigate a series of HTML pages through a standard web browser to view and, where permitted, adjust module parameters. For additional information, see the configuration guide for your Prisma II system release.

Configuration Summary

You can use any of the methods listed above to perform the following configuration tasks:

- Enable or disable each receiver channel
- Force Mute
- Force Alarm (to check redundant modules, only works when the receiver is in the Master mode.)
- Select Master, Slave, or Single operation
- Select attenuation level per channel
- Select receiver mode
- Select node to view

For detailed information on configuring this module, refer to *Operation Using ICIM* (on page 75) or *Operation Using LCI* (on page 107).

2

Module Installation

Introduction

This chapter contains instructions for installing the module and describes the site requirements, equipment, and tools needed for module installation.

In This Chapter

■ Preparing for Installation.....	48
■ Site Requirements	49
■ Connecting the RF Cables to the Chassis	54
■ Installing the Module in the Chassis.....	56
■ Cleaning Optical Connectors	61
■ Connecting Optical Cables	63
■ Connecting the ICIM to Additional Chassis.....	67
■ Configuring Redundancy	69

Preparing for Installation

Before you begin, make sure that the module is in good condition and that you have the tools and equipment listed here.

Unpacking and Inspecting the Module

As you unpack the module, inspect it for shipping damage. If you find any damage, contact Cisco Services. Refer to *Customer Information* (on page 139) for contact information.

Equipment and Tools Needed

Before you begin, make sure that the module is in good condition. You need the following equipment and tools to install these modules.

You need . . .	To . . .
a Prisma II or Prisma II XD Chassis with power supply	provide housing, power, and input/output connections to the module.
3/8-in. flat-blade screwdriver	secure the module in the chassis.
optical cables with connectors	carry optical input and output signals.
optical cleaning materials	clean optical connectors.
optical power meter	verify optical input and output levels.
spectrum analyzer (for transmitter)	verify proper RF input.

Site Requirements

Before you begin, make certain that your installation site meets the requirements discussed in this section.

Access Requirements



WARNING:

Use this product in locations that restrict access to all persons who are not authorized. Otherwise, personal injury or equipment damage may occur.

Ensure that only authorized personnel have access to this equipment. Otherwise, personal injury or equipment damage may occur.

Equipment Rack

To install this module, your site must be equipped with an Electronics Industry Association (EIA) equipment rack that properly houses the chassis with proper spacing for air circulation. For instructions on installing the chassis in the rack, refer to the guide that was shipped with the chassis.

Operating Environment



CAUTION:

Avoid damage to this product! Operating this product outside the specified operating temperature limits voids the warranty.

Follow these recommendations to maintain an acceptable operating temperature of the equipment.

- The temperature of the module must be maintained between 0°C and 50°C (32°F and 122°F).
- Keep cooling vents clear and free of obstructions.
- Provide ventilation as needed using air-deflecting baffles, forced-air ventilation, or air outlets above enclosures, either alone or in combination.

Power Requirements

All Prisma II application modules receive their electrical power from the chassis. The modules may be installed with the chassis under power.

Note: It is recommended to install no more than 20 QEDR receiver under Prisma II Standard chassis power supply.

Space Requirements

This is a single-width, half-height module. Actual space requirements depend on whether the module is installed in a Prisma II standard or a Prisma II XD chassis.

Prisma II Standard Chassis Installation

When installed in a Prisma II standard chassis, the module is placed in a host module and then inserted into the chassis in slots 5 through 16.

- If the module occupies the upper host module position, its slot number is the same (5 through 16) as that of the host module.
- If the module occupies the lower host module position, its slot number is 16 plus the host module slot number, or 21 through 32.

Slots 1 through 4 are usually reserved for the power supplies. If an ICIM is installed, it occupies slots 15 and 16. If an ICIM is not installed, any other module (or host module) can occupy these slots.

Slots 2 and 4 are reserved for an internal power supply, if installed. If an internal power supply is not installed here, any other module (or host module) can occupy these slots.

Prisma II XD Chassis Installation

When installed in a Prisma II XD Chassis, the module is inserted directly into an available application module slot on the chassis front panel. The application module slots are numbered 1 through 16.

The chassis power supplies and ICIM are installed in dedicated slots on the chassis back panel, so slots 1 through 16 are available for application modules no matter how the chassis is configured.

Prisma II Standard Chassis Style

The Prisma II standard chassis may be configured as front-access or rear-access depending on the system you have purchased. Power, RF input or output, and other connectors may be located on either the front or rear of the chassis. Connections to the chassis serve the same function and are made in the same manner regardless of the location of the connectors or chassis configuration.

Rear-Access Chassis - Front Panel Illustration

The following illustration shows the front of the rear-access Prisma II standard chassis with two power supplies, 10 full-height modules, and the ICIM installed.

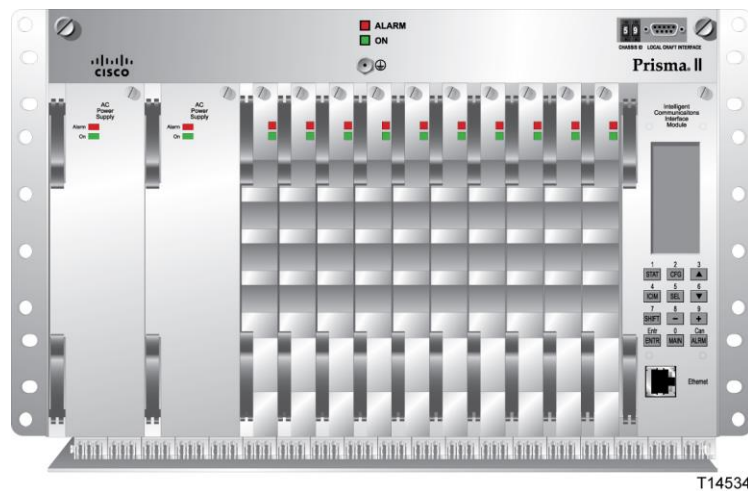

Front-Access Chassis - Front Panel Illustration

The following illustration shows the front of the front-access Prisma II standard chassis with two power supplies, 10 full-height modules, and the ICIM installed.

The power inlets, RF input/output, and RF ports are located on the recessed bottom of the connector interface panel on the front-access version of the chassis.

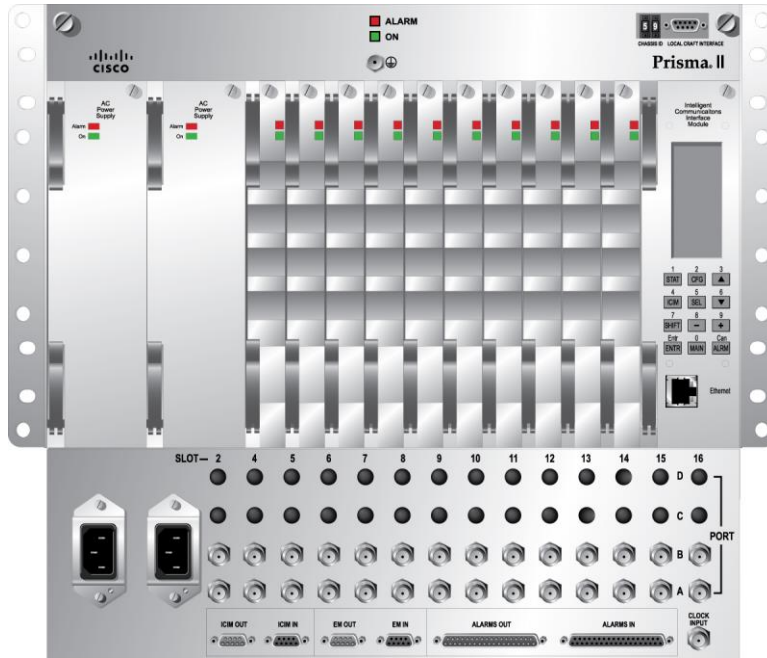

T14535

Prisma II XD Chassis Style

The Prisma II XD chassis back panel serves as both a connector panel and a receptacle for AC power supply modules and the ICIM2-XD, when installed.

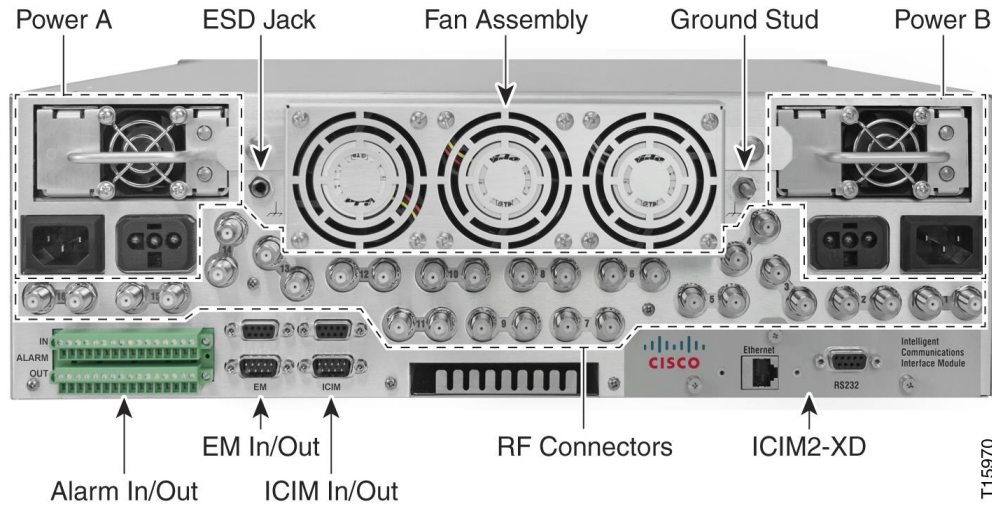

The RF connectors are arranged in pairs, and each pair is numbered to identify its corresponding module slot. The Port A connector in each pair is identified by a black retaining nut and a black circle in the panel artwork, while the Port B connector is unmarked. The Port A and Port B connectors correspond to the upper and lower connectors, respectively, on the chassis midplane.

Connecting the RF Cables to the Chassis

To Connect RF Cables for Each Module

Complete the appropriate procedure below to connect RF cables for the module.

Note: This procedure assumes that the chassis is mounted in a rack.

Standard Prisma II Chassis

Note: This procedure assumes a host module with receivers in both lower and upper half-slot positions. If only one receiver installed, it is not necessary to connect RF cables for the unused position.

- 1 Locate the RF ports on the chassis connector panel. The connector panel is on the front of a front-access chassis, and on the rear of a rear-access chassis. The figure below shows the connector panel for a rear-access chassis.

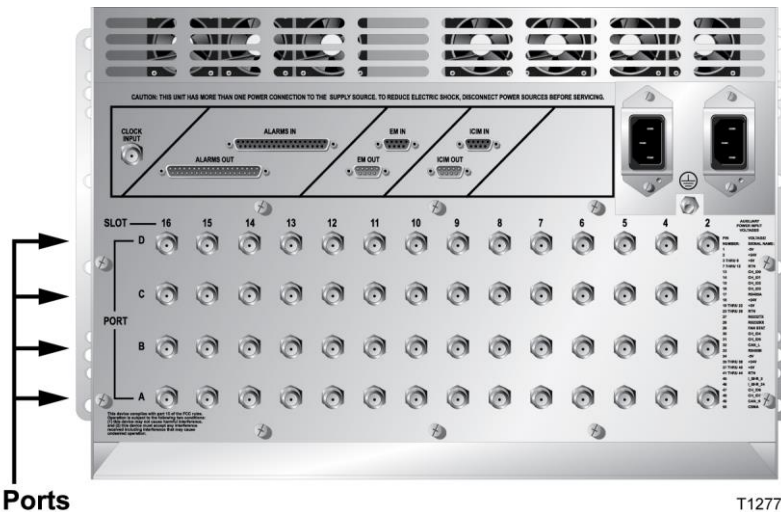

RF Ports

T12770

- 2 Connect RF cables to the Port A and Port C connectors for the chassis slot in which the host module will be installed. These are the RF output connections for the module in the lower half-slot position. Hand-tighten the connectors.

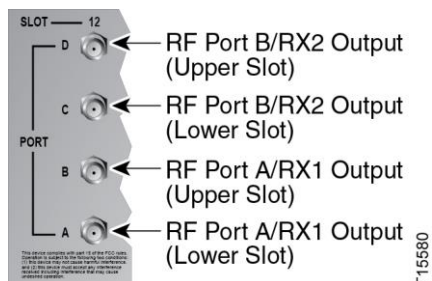

T15580

- 3 Route the RF cables from Ports A and C (for the lower half-slot module) to the appropriate RF destinations.
- 4 Connect RF cables to the Port B and Port D connectors for the chassis slot in which the module will be installed. These are the RF output connections for the module in the upper half-slot position. Hand-tighten the connectors.
- 5 Route the RF cables from Ports B and D (for the upper half-slot module) to the appropriate RF destinations.
- 6 If F connectors are installed, use a 7/16-in. open-end wrench to secure all cables to the connectors at the chassis.

Prisma II XD Chassis

- 1 Attach a 75-ohm RF cable to the appropriate RF destination.
- 2 Locate the RF ports at the back of the chassis. In this diagram, the RX1 and RX3 are routed to Port A, RX2 and RX4 are routed to Port B. Another configuration is that RX1 to RX4 are all routed to Port A.

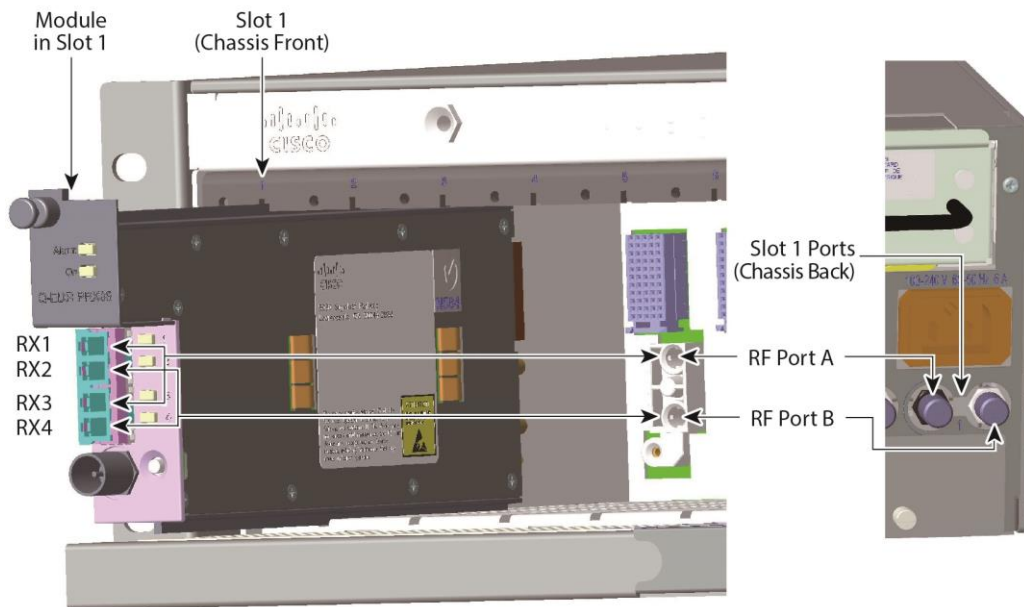

- 3 Attach the other end of the RF cable to Port A connector of the corresponding slot where the module is to be installed. This is the RF output connection.
- 4 If F connectors are installed, use a 7/16-in. open-end wrench to secure all cables to the connectors at the chassis.

Installing the Module in the Chassis

To Install the Receiver Modules in the Host Module

Note:

- All Prisma II high-density application modules must be installed in a host module before they can be mounted in a standard Prisma II Chassis.
- Prisma II host modules prior to Rev C (date codes through A2006) do not support the Controller Area Network (CAN) bus.
- To support CAN bus redundancy, the ICIM2 must be Rev B or later.

Complete the following steps to install the application modules in the host module.

- 1 Align the ridges on the top and bottom of the module with the guide slots located on the host module and the chassis. Be careful to keep the module level as you slide it into the host to avoid bending the pins on the host back plane.
- 2 Gently slide the module into the host module until you feel the power and communications connections on the back of the module join connectors on the host module. Use the thumbscrew on the top of the module to lock it in place.

Host Module Empty

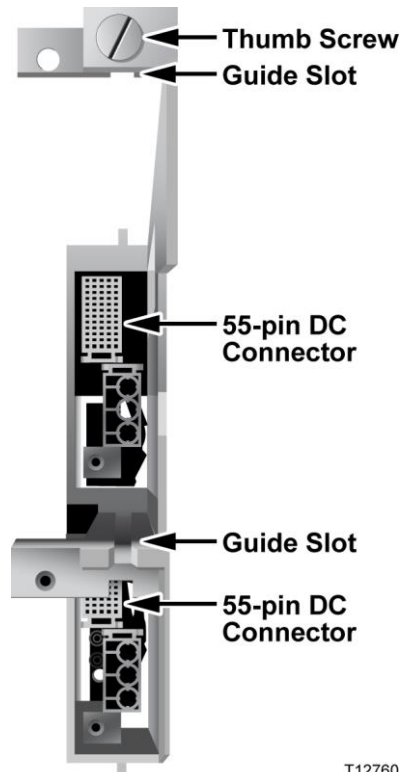

Host Module Populated



T12760

To Install the Module in the Chassis

Note: This procedure assumes that the chassis is mounted in a rack.

- 1 Locate the fiber guides at the bottom of the chassis and the module guide slots inside the chassis as shown in the following illustration.

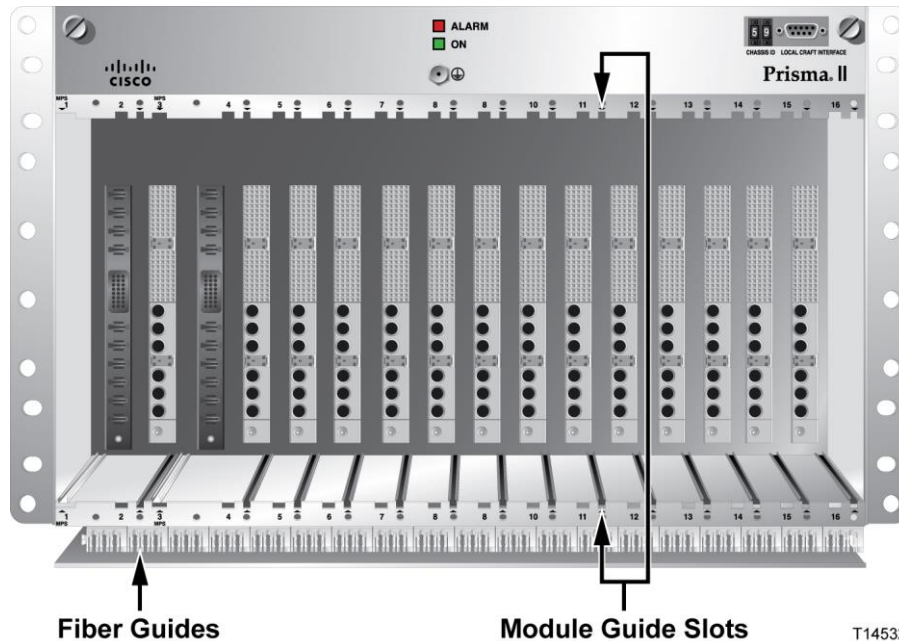

- 2 Align the ridges on the top and bottom of the host module with the guide slots on the chassis. Be careful to keep the host module level as you slide it into the chassis to avoid bending the pins on the back plane bus.
 - 3 Gently slide the host module into the chassis until you feel the connections on the back of the host module join connectors on the back plane bus.
- Note:** Do not force or bang the host module into the chassis. If properly aligned, the host module should slide in with minimal force.

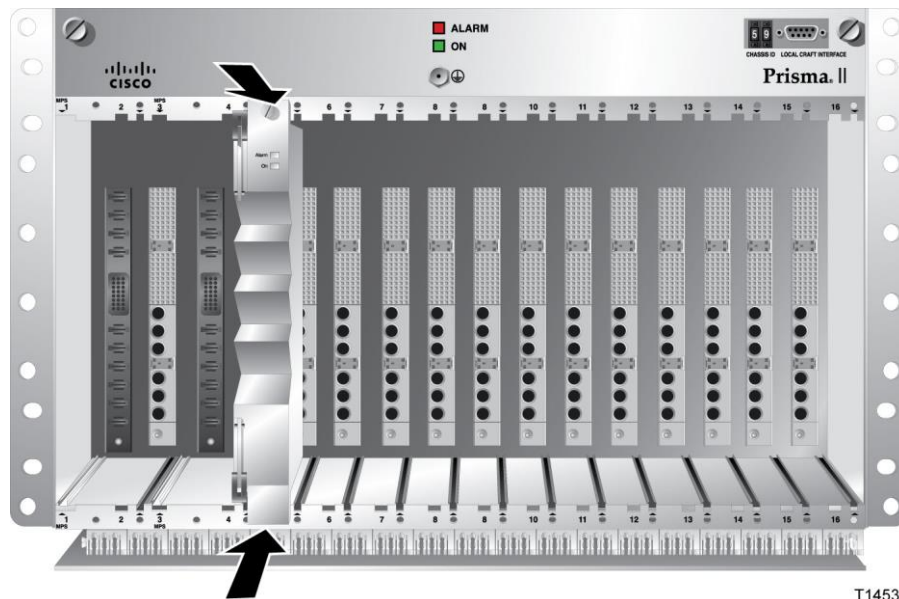

- 4 Hand-tighten the screw at the top of the host module to ensure that the first few threads engage smoothly. Use a 3/8-in. flat-blade screwdriver to secure the mounting screw. **Do not over-tighten.** The maximum torque value is 5 in-lb.
- 5 Fill any unused chassis slots with module blanks to help ensure proper cooling air flow. Blanks for high density modules are available to fill unused host module slots.

To Install the Module in a Prisma II XD Chassis

Note: This procedure assumes that the chassis is installed in a rack.



WARNING:

Avoid damage to your eyes! Do not look into any optical connector while the system is active. Even if the unit is off, there may still be hazardous optical levels present.

Complete the following steps to install the module in the chassis.



CAUTION:

Always use a screwdriver to loosen or tighten the screws holding the application modules, ICIM2-XD, fan assembly, power supply modules, DC-to-DC converters, or blanking panels in place. Do not attempt to loosen or tighten these screws solely by hand.

- 1 Locate the fiber guides at the bottom of the chassis and the module guide slots inside the chassis as shown in the following illustration.

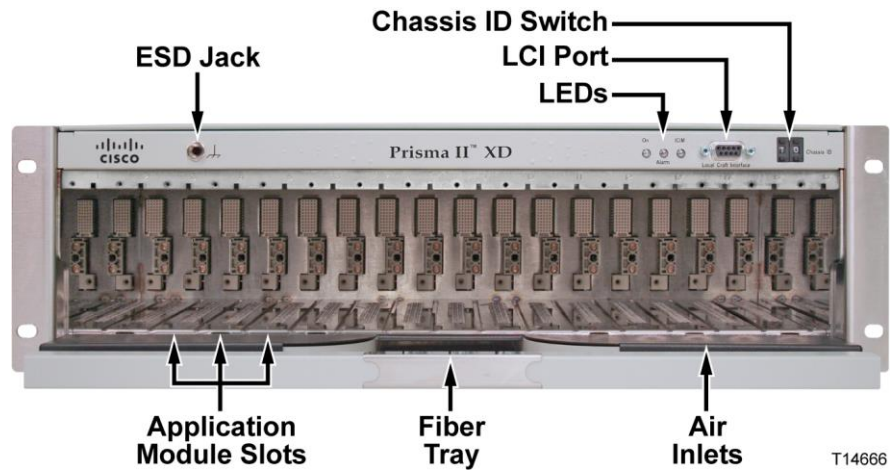

- 2 Align the ridges on the top and bottom of the module with the module guide slots located on the chassis.
- 3 Gently slide the module into the chassis until its power and communications connections join connectors on the midplane bus. *Do not force the module into the chassis.* If properly aligned, it should slide in with minimal force.

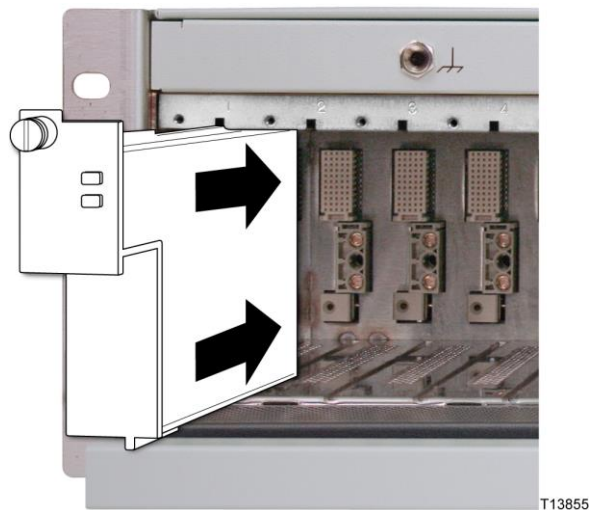

- 4 Tighten the screw at the top of the module to secure it in the chassis. Use a 3/8-in. flat-blade screwdriver to secure. *Do not over-tighten.*
- 5 Fill any unused chassis slots with module blanks to help ensure proper cooling air flow.

Cleaning Optical Connectors

**CAUTION:**

Proper operation of this equipment requires clean optical fibers. Dirty fibers will adversely affect performance. Proper cleaning is imperative.

The proper procedure for cleaning optical connectors depends on the connector type. The following describes general instructions for fiber optic cleaning. Use your company's established procedures, if any, but also consider the following.

Cleaning fiber optic connectors can help prevent interconnect problems and aid system performance. When optical connectors are disconnected or reconnected, the fiber surface can become dirty or scratched, reducing system performance.

Inspect connectors prior to mating, clean as needed, and then remove all residue. Inspect connectors after cleaning to confirm that they are clean and undamaged.

Recommended Equipment

- CLETOP or OPTIPOP ferrule cleaner (for specific connector type)
- Compressed air (also called “canned air”)
- Lint-free wipes moistened with optical-grade (99%) isopropyl alcohol
- Bulkhead swabs (for specific connector type)
- Optical connector scope with appropriate adaptor

Tips for Optimal Fiber Optic Connector Performance

- Do not connect or disconnect optical connectors with optical power present.
- Always use compressed air before cleaning the fiber optic connectors and when cleaning connector end caps.
- Always install or leave end caps on connectors when they are not in use.
- If you have any degraded signal problems, clean the fiber optic connector.
- Advance a clean portion of the ferrule cleaner reel for each cleaning.
- Turn off optical power before making or breaking optical connections to avoid microscopic damage to fiber mating surfaces.

To Clean Optical Connectors



Warning:

- Avoid personal injury! Use of controls, adjustments, or procedures other than those specified herein may result in hazardous radiation exposure.
- Avoid personal injury! The laser light source on this equipment (if a transmitter) or the fiber cables connected to this equipment emit invisible laser radiation.
- Avoid personal injury! Viewing the laser output (if a transmitter) or fiber cable with optical instruments (such as eye loupes, magnifiers, or microscopes) may pose an eye hazard.

- Do not apply power to this equipment if the fiber is unmated or unterminated.
- Do not stare into an unmated fiber or at any mirror-like surface that could reflect light emitted from an unterminated fiber.
- Use safety-approved optical fiber cable to maintain compliance with applicable laser safety requirements.

Important: Ensure that no optical power is present prior to this procedure.

- 1 Turn optical power off to the connector.
- 2 Using an optical connector scope, inspect the connector for scratches, burns, or other signs of damage.

Note: If the connector is damaged, replace the jumper.

- 3 If the connector requires cleaning, swipe it across the face of the appropriate ferrule cleaner several times. This will remove dust and some films.

Note: You may hear a slight "squeak" while cleaning the connector, indicating that it is clean.

- 4 Inspect the connector again. If the connector requires further cleaning, clean it using 99% isopropyl alcohol and a lint-free wipe.
- 5 Swipe the connector across the face of the appropriate ferrule cleaner several more times to remove any film left by the alcohol.
- 6 Repeat all the steps above as needed until the connector is clean.

Connecting Optical Cables

Cable Routing - Prisma II Chassis

Fiber Fish Tool

**WARNING:**

Unterminated fiber cables and connectors may emit invisible laser radiation. Avoid direct exposure to the laser light source. Ensure that the fiber cable is terminated before "fishing."

The Fiber Fish tool that was shipped with the Prisma II Chassis is used to pull an optical cable from the rear of the chassis to the front of the chassis so the optical cables can be connected to optical connectors on the front panel of the modules.



T8808

Fiber Fish Tool Hook

At the end of the Fiber Fish tool is a small hook that allows you to hold an optical cable so that you can pull it through to the front panel of the chassis.

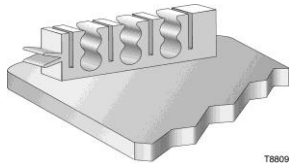

T8809

To Pull the Optical Cable to the Module

- 1 Insert the Fiber Fish tool through the slot located just above the bottom of the chassis.
- 2 At the rear of the chassis, locate the appropriate optical cable.
- 3 Insert the optical cable into the notched area of the Fiber Fish tool as shown below.

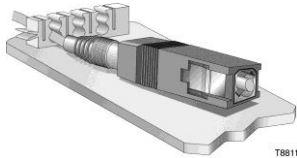

- 4 At the front of the chassis, pull the Fiber Fish tool (with cable attached) to the front of the chassis.
- 5 Disengage the optical cable from the Fiber Fish tool and attach to the appropriate connector on the desired module.

Cable Routing - Prisma XD Chassis

Feed each fiber through the fiber tray located beneath the Prisma XD Chassis. The fiber tray slides in and out to facilitate routing.

To Connect Optical Cables to Module

Important: Observe laser safety precautions. Refer to Laser Safety information earlier in this guide.

Note: This procedure assumes that the chassis is mounted in a rack and that the optical cable has been installed at the node.



CAUTION:

The OPM is sensitive to electrostatic discharge. Always use an ESD strap or similar individual grounding device when handling or coming into contact with these modules.



CAUTION:

Removing and installing the OPM can shorten its useful life. Do not remove and insert the OPM more often than absolutely necessary.

Complete the following steps for each optical cable to be connected to the module.

- 1 Select the appropriate OPM for the receiver from one of the following:
 - OPM P/N 4044008 for standard range
 - OPM P/N 4044009 for extended range
- 2 Remove the dust plugs from the OPM and save them for possible future use.
- 3 Line up the OPM with the optical input connector on the front of the receiver and slide the OPM into the connector.

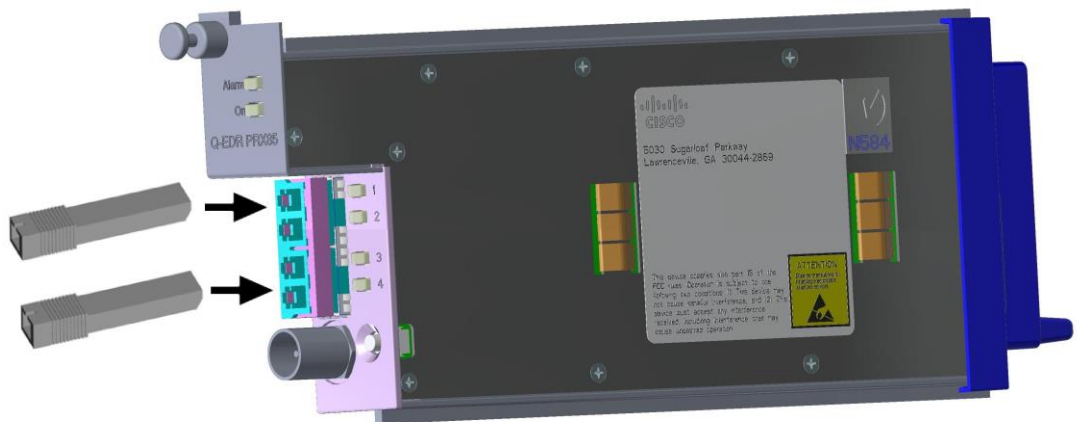

- 4 Insert the receiver end of the fiber optic connector into its receptacle on the OPM.

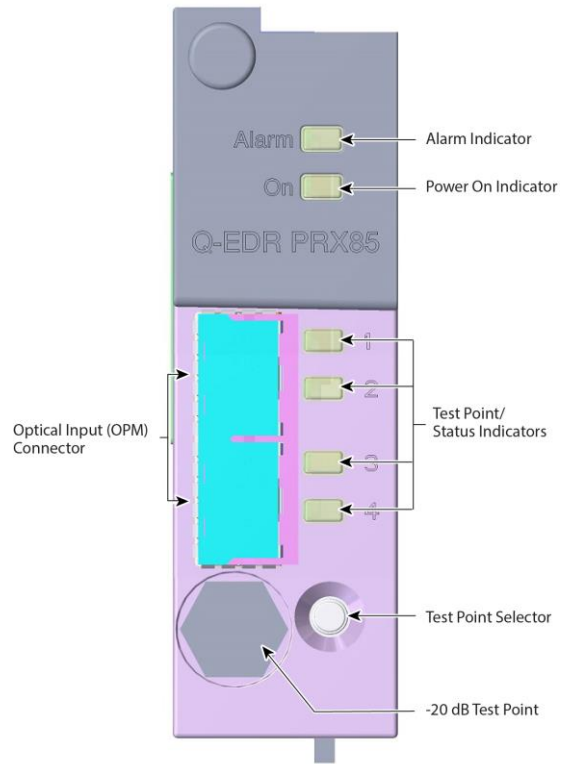

- 5 Route the other end of the optical cable to the appropriate destination.

Connecting the ICIM to Additional Chassis

The Prisma II platform allows the ICIM2 or ICIM2-XD to be located in one chassis and control modules located in several other chassis. This communication “daisy-chain” can be enabled by connecting cables to the **ICIM IN** and **ICIM OUT** connectors located on the connector interface panel of the chassis. This connection is required if an ICIM2 or ICIM2-XD in one chassis is to communicate with or control any module located in a separate chassis.

Note: An ICIM2 or ICIM2-XD can control a maximum of 140 modules. Depending on your application, this is typically 6 or 7 chassis to a rack. Do not exceed these limits.

ICIM IN and ICIM OUT Connectors

Every Prisma II standard and Prisma II XD chassis has a DB9 **ICIM IN** and a DB9 **ICIM OUT** connector for the purpose of chassis-to-chassis ICIM connections. **ICIM IN** is a female connector and **ICIM OUT** is a male connector.

Prisma II Standard Chassis



Prisma II XD Chassis

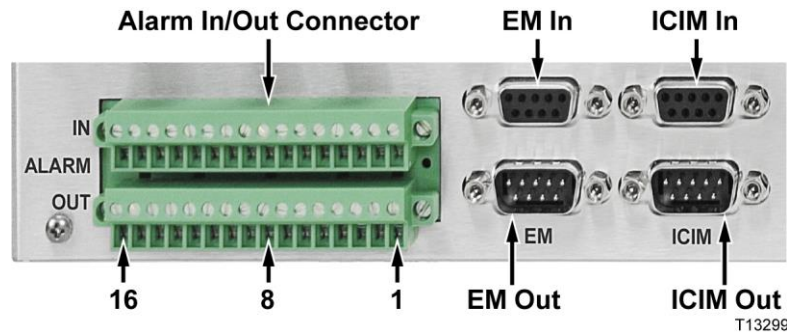

ICIM IN and ICIM OUT Cables

The cable required for both **ICIM IN** and **ICIM OUT** connections is a shielded 9-wire serial extension cable, DB9 Female to DB9 Male. This cable can be purchased

locally or from the factory. The chassis data sheet lists the part number for a 6-foot DB9 Female to DB9 Male serial extension cable. The connectors are a serial 9-pin D-shell (EIA 574/232).

To Connect Chassis-to-Chassis ICIM IN and ICIM OUT Ports

- 1 Connect the serial extension cable from the **ICIM OUT** of the chassis containing the ICIM to the **ICIM IN** connector of the second chassis.
- 2 Connect a serial extension cable from the **ICIM OUT** of the second chassis to the **ICIM IN** of the third chassis.
- 3 Continue this daisy-chain connection until all chassis are connected.
- 4 Connect an **ICIM OUT** terminator, part number 4013014, to the **ICIM OUT** connector on the last chassis in the daisy-chain connection. The **ICIM OUT** terminator ships with the ICIM.

Important:

- All chassis connected in the daisy-chain must be powered and have a fan tray installed. A chassis connected in the daisy-chain that is not powered or has no fan tray installed will cause faulty operation of the ICIM.
- All chassis connected in this daisy-chain must have a unique chassis ID number.
- If the **ICIM OUT** terminator that ships with the ICIM is not installed on the last chassis of a daisy-chain connection, faulty communication with the ICIM may occur.

Configuring Redundancy

You configure the receiver module for redundancy by using the ICIM or LCI to place both receiver channels in either Master or Slave operating mode. Then, using a redundancy interface panel, you hard-wire the desired Master-Slave relationships between receiver modules.

This section explains the hardware configurations required to support redundancy. Procedures for using the ICIM or LCI to configure the module for redundancy are provided in *Operation Using ICIM* (on page 75) and *Operation Using LCI* (on page 107).

External Alarm Connections

The Prisma II Standard and XD Chassis can be configured for local hard-wired redundancy using the **ALARM IN** and **ALARM OUT** connectors located on the connector interface panel. A pair of application modules can be configured in a Master-Slave relationship so that, if the Master fails, the Slave takes over in response to **ALARM IN** and **ALARM OUT** signaling.

This module ships from the factory configured for Single mode operation. In Single mode, the module acts as a stand-alone device unaffected by the alarm status of any other application module. When used in pairs in a redundant configuration, one module in the pair is set to Master mode operation and the other is set to Slave mode.

With this configuration, the Master communicates its critical alarm status to the Slave. When the Master module is not in alarm, the Master is enabled and the Slave is disabled. When the Master is in alarm, the Master is disabled and the Slave is enabled.

The ICIM2 front panel, LCI, ROSA, CLI, or ICIM Web Interface can be used to select Master, Slave, or Single mode operation of the module as needed.

ALARMS IN and ALARMS OUT Connectors

Every Prisma II standard and Prisma II XD chassis provides connectors for external alarms to and from each module slot. These alarm connectors are located on the chassis connector panel and are labeled **ALARMS IN** and **ALARMS OUT**.

For detailed information on **ALARM IN** and **ALARM OUT** connectors, see the *Prisma II Chassis Installation and Operation Guide*, part number 713375 or the *Prisma II™ XD Platform System Guide*, part number 4021339.

When a critical alarm occurs in a Master module, the Master turns off and the Slave (redundant module) is enabled. To make this happen, the pin representing the Master module slot in the **ALARM OUT** connector must be externally wired to the pin representing the Slave module slot in the **ALARM IN** connector. After wiring these contacts, take care to ensure that the Master and Slave modules are not moved to other slots. Otherwise, the **ALARM IN** and **ALARM OUT** connectors will need to be rewired to the appropriate pins.

Note:

- Any device configured as Single or Master ignores its **ALARM IN** contacts.
- To verify proper wiring and redundant configuration, simply unplug the Master module and observe that the Slave module turns on.

ALARMS IN and ALARMS OUT Connector Illustration

Prisma II Standard Chassis

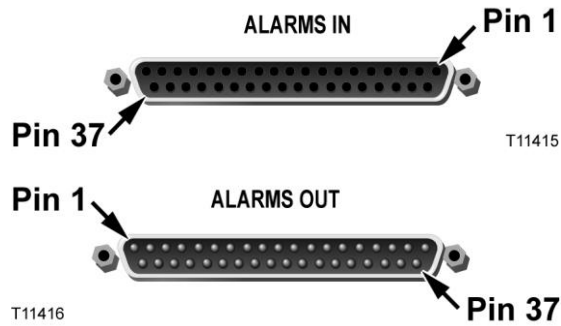

Prisma II XD Chassis

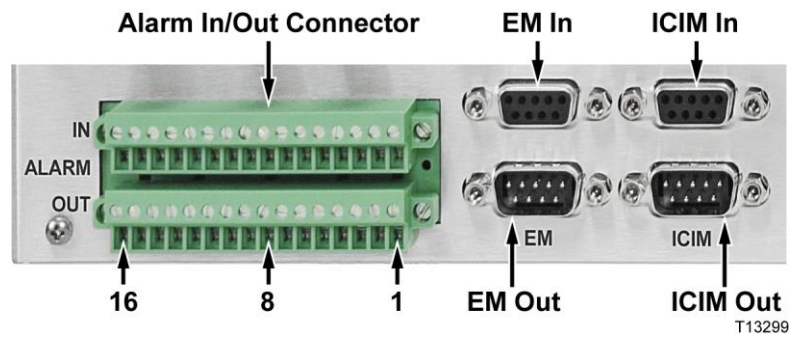

Master/Slave Illustration

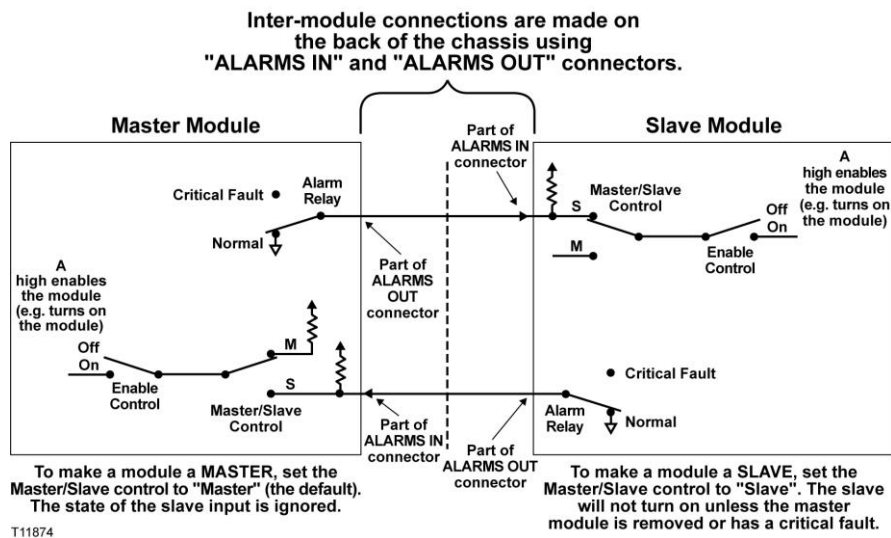

Redundancy Interface Panel

The Prisma II Redundancy Interface Panel is an accessory to the Prisma II platform. It is intended to be used with the master/slave feature and the contact closure alarm feature of the Prisma II platform.

The Prisma II Redundancy Interface Panel serves as an extension to the two DB-37 connectors labeled **ALARM IN** and **ALARM OUT** on the connector interface panel of the chassis. The terminals on the redundancy interface panel are extensions of pins on the **ALARMS OUT** and **ALARMS IN** connectors on the chassis.

For additional information, see the *Prisma II Chassis Installation and Operation Guide*, part number 713375.

Prisma II Redundancy Interface Panel Illustrations

Front Panel

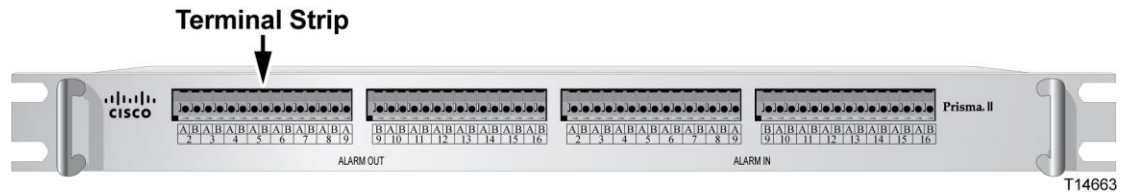

Back Panel

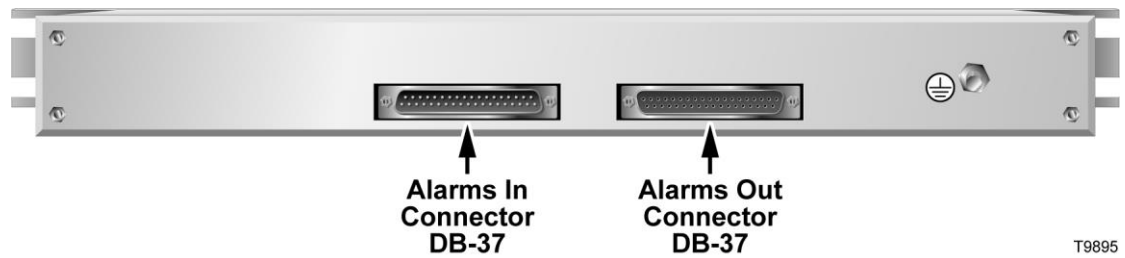

Close-up of Front Panel Terminal Strips



T11921

3

Operation using ICIM

Introduction

The procedures in this chapter apply if you are using the Prisma II ICIM2 front-panel interface to configure and operate the module. For information on using CLI commands or the ICIM Web Interface to configure and operate the module, see the Configuration Guide for your system release.

Scope of This Chapter

Included in this chapter are descriptions of the ICIM2 front-panel keyboard and liquid crystal display (LCD), and detailed procedures on how to use front-panel menus to configure the module.

Note: You must use CLI commands or the ICIM Web Interface to configure and operate the module when using the ICIM2-XD. For details, see the Configuration Guide for your system release.

In This Chapter

- ICIM Introduction..... 77
- ICIM2 Front Panel 79
- ICIM Password..... 82
- Operating the ICIM 88
- Checking the Operating Status using the ICIM..... 94
- Configuring the Module using the ICIM 96
- Checking Alarms using the ICIM..... 99
- Checking Manufacturing Data using the ICIM..... 103
- Saving the Configuration using the ICIM 105
- Adjusting Alarm Thresholds..... 106

ICIM Introduction

Laser Warning



WARNING:

- Avoid personal injury! Use of controls, adjustments, or procedures other than those specified herein may result in hazardous radiation exposure.
 - Avoid personal injury! The laser light source on this equipment (if a transmitter) or the fiber cables connected to this equipment emit invisible laser radiation. Avoid direct exposure to the laser light source.
 - Avoid personal injury! Viewing the laser output (if a transmitter) or fiber cable with optical instruments (such as eye loupes, magnifiers, or microscopes) may pose an eye hazard.
- Do not apply power to this equipment if the fiber is unmated or unterminated.
 - Do not stare into an unmated fiber or at any mirror-like surface that could reflect light emitted from an unterminated fiber.
 - Do not view an activated fiber with optical instruments such as eye loupes, magnifiers, or microscopes.
 - Use safety-approved optical fiber cable to maintain compliance with applicable laser safety requirements.
 - Even if the unit is off, there may still be hazardous optical levels present.

ICIM Function

The ICIM functions as the module-user interface as well as the interface between the Prisma II modules and your network management system.

The ICIM allows local module configuration and status monitoring for up to 140 modules located in multiple chassis. The ICIM features easy-to-use software that can be navigated locally on models equipped with a front-panel keypad and LCD display.

The ICIM can also be navigated remotely using CLI commands or the ICIM Web Interface. For additional information, see the configuration guide for your Prisma II system release.

Important:

- Do not operate any Prisma II Chassis without a fan tray installed properly. If a

fan tray is not installed in the Prisma II Chassis, the ICIM will not communicate with any of the modules in that chassis.

- All chassis connected in a daisy-chain must be powered and have a fan tray installed. A chassis that is connected but is either not powered, or does not have a fan tray installed will cause faulty operation of the ICIM.
- All chassis connected in this daisy-chain must have a unique chassis identification (ID) number.
- The last chassis in the daisy-chain must have a terminator installed in the **ICIM OUT** connector. Otherwise, faulty communication with the ICIM may occur.

ICIM Block Diagram

A block diagram representing the ICIM2 or ICIM2-XD is shown below.

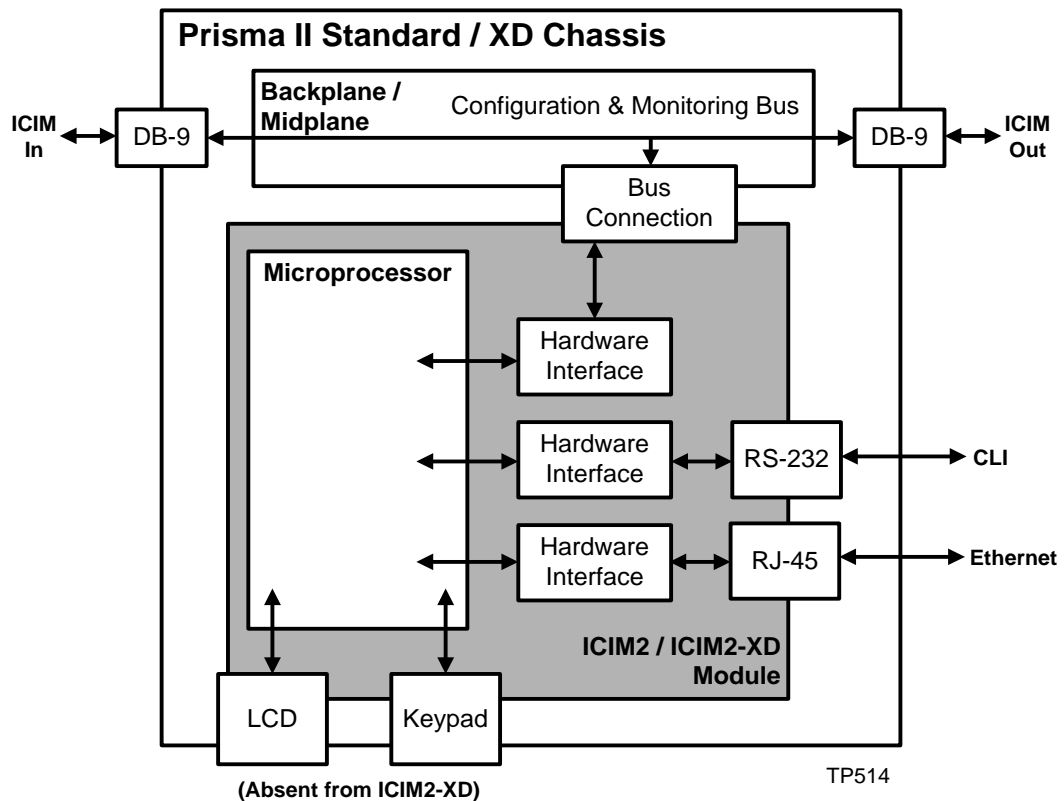

ICIM2 Front Panel

ICIM2 Illustration (Front Panel)

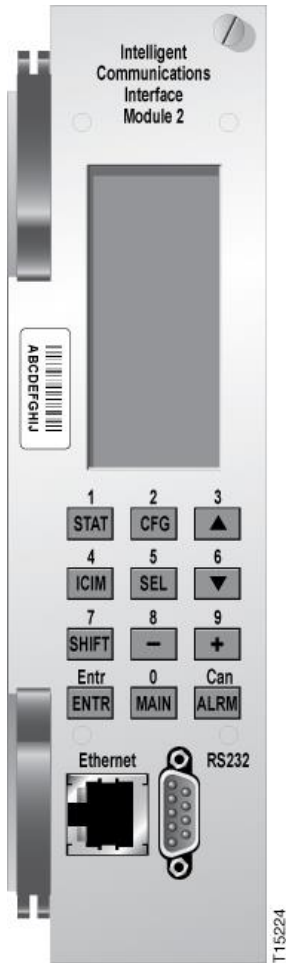

ICIM2 Front Panel Features

Part	Function
LCD screen	Displays the ICIM2 menus, alarms, and status information.
12-key numeric keypad	Used to navigate the ICIM2 menus and configure the application modules.
Ethernet connector	Directly connects the ICIM2 to an IP network. The ICIM2 Ethernet port is suitable for connection to intra-building wiring, non-exposed wiring or cabling only.
Yellow LED on Ethernet connector	Blinks to indicate Ethernet receive activity.
Green LED on Ethernet connector	Glowes when a link is established on the Ethernet port.
RS232 connector	Used to connect a PC to the Prisma II system for CLI communication and setup.

ICIM LCD

The ICIM LCD is the operator’s visual link to the ICIM software. When the ICIM is installed and powered up, the **MAIN** menu is displayed on the LCD.

ICIM MAIN Menu Illustration



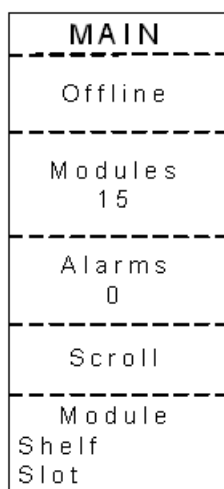









The ICIM MAIN menu is shown below.



TP011

ICIM Keypad

The ICIM keypad has 12 keys that allow you to input and monitor operational parameters. Each key and a brief description of its function are shown here.

Button	Function
	Displays status information for the selected module.
	Displays configuration information for the selected module.
	Displays all of the parameters in alarm for a selected module.
	Moves the menu selection area up. Also increases numerical readings of selected configuration parameters.
	Moves the menu selection area down. Also decreases numerical readings of selected configuration parameters.
	Selects the highlighted parameter.
	Displays ICIM module information such as firmware version, serial number, and baud rate.
	Shifts function of a keypad button to the function or number label just above that button.
	Decreases numerical readings of selected configuration parameters.
	Increases numerical readings of selected configuration parameters.
	Enters input data (if valid).
	Exits the current menu and displays the MAIN ICIM menu.

ICIM Password

The ICIM allows you to send configuration commands, change alarm thresholds, and restore factory default settings in Prisma II modules. To prevent unauthorized changes to these parameters, you have the option of using a password protection system. Password authorization only applies to configurable parameters. Status and alarm information is always available on the ICIM, regardless of password implementation.

Note: The following instructions pertain to the use of the ICIM2 front-panel interface (LCD and keyboard). Remote password and other administrative functions are also supported using CLI Commands or the ICIM Web Interface. For details, see the Configuration Guide for your system release.

Password Protection System

The ICIM menu options available in the password protection system are shown here.



ICIM Menu Option	Description
User Psw	A user-settable password. <ul style="list-style-type: none"> ■ Created, entered, and changed by the system operator(s) ■ Must be exactly eight digits, using only the 0-9 number keys
Change Psw	Changes an existing user password.
Disable Psw	Disables the user password function.
SA Psw	A service password used by factory personnel only.

Important: If you only want to monitor status and alarm data, skip the password function when it appears on the ICIM menu. You can access all module status and alarm information without a password.

However, once a user password is entered, you are required to enter it every time you want to set configurable parameters to any module controlled by that ICIM. Refer to *Expired Password or Inactive Password Messages* (on page 83) and *To Enter the User Password* (on page 84).

To Access the Password Menu

The Password menu allows you to create, enter, change, or disable the user password. It also allows service personnel to use the factory default password.

- 1 Press the  key.
- 2 Use the  key to scroll down until **Password** is highlighted.
- 3 Press the  key. The Password menu appears. **User Psw** is highlighted.

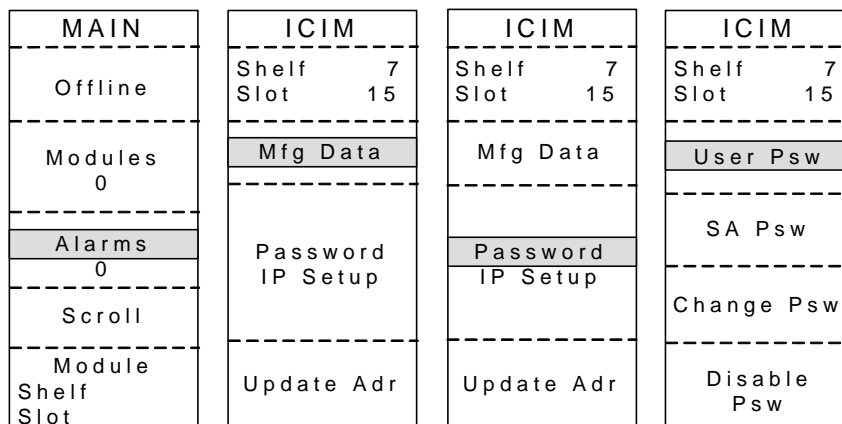

TP012

Expired Password or Inactive Password Messages





The entry of a valid password allows changes to system parameters for a period of 10 minutes. If more than 10 minutes has passed since your last keystroke, and you attempt to make any changes to system parameters, the menu displays **Psw Expired**. If, after more than 10 minutes, you attempt to disable the password the menu displays **Failed, Password Not Active**. If either of these messages is displayed, you are required to re-enter the password. To re-enter the password, follow the procedure in *To Enter the User Password* (on page 84).

To Enter the User Password

To use the user password feature, you must create and enter a password of exactly eight digits using only the 0-9 number keys.

The password remains active for 10 minutes after your last keystroke. To change configuration parameters after 10 minutes, you must re-enter your password.

Complete the following steps to enter a user password.

- 1 Access the Password menu as shown in *To Access the Password Menu* (on page 83).
- 2 Press the  key. The user password menu appears.
- 3 When **User Psw/Shift Off** appears, press the  key to display **Shift On**, and then enter the eight digits of your password, using the 0-9 number keys.
 - To change a digit you have just typed, use the **CAN** (Cancel) function by pressing the  key. This deletes the last digit typed.
- 4 Press the  key to enter the password. The ICIM2 or ICIM2-XD display updates to show whether your password entry was accepted.
 - If the password is accepted, the word **Accepted** appears in the menu, and you are able to return to the MAIN menu.
 - If the password was rejected, the word **Rejected** appears in the menu. Reasons for a password to be rejected include:
 - Entering more than eight digits for the password.
 - Pressing keys other than the 0-9 number keys.
 - Entering an incorrect password if a valid password has been entered.







If the password is rejected, press the  key to return to the password menu and re-enter the password as described in step 3 above.

ICIM	ICIM	ICIM	ICIM
Shelf 0 Slot 15	Shelf 0 Slot 15	Shelf 0 Slot 15	Shelf 0 Slot 15
User Psw	User Psw *****	User Psw 1234****	User Psw 12345678
Shift Off	Shift On	Rejected Shift Off	Accepted Shift Off

TP013

To Change the User Password

If a user password has been entered, it may be changed. However, the current password must be active prior to changing it. If the current password has expired (more than 10 minutes have passed since your last keystroke), you must re-enter the current password before changing to a new one.

- 1 Access the Password menu as shown in the procedure *To Access the Password Menu* (on page 83).
- 2 Use the  key to scroll down until **Change Psw** is highlighted.
- 3 Press the  key to select **Change Psw**.
- 4 When **Change Psw /Shift Off** appears, press the  key to display **Shift On**, and then enter the eight digits of your new password, using the 0-9 number keys. If at any time you input a digit that is incorrect or wish to change a digit, use the **CAN** (Cancel) function by pressing the  key to delete that digit.
- 5 Press the  key to input the new password. As a result:
 - The ICIM updates the display to show if your password entry was accepted or rejected.
 - If the entry was accepted, you are able to return to the MAIN menu.
- 6 If the new password you entered is rejected, press the  key to return to the password entry menu. Clear all digits using the **CAN** (Cancel) function, then re-

enter an 8-digit password using only the 0-9 number keys. Press the **ENTER** key to input the password.





ICIM	ICIM	ICIM	ICIM
Shelf 7 Slot 15	Shelf 7 Slot 15	Shelf 7 Slot 15	Shelf 7 Slot 15
User Psw	Change Psw	Change Psw *****	Change Psw 87654321
SA Psw			
Change Psw			
Disable Psw	Shift Off	Shift On	Shift On

TP014

To Disable the User Password using ICIM

If a user password has been entered, you may disable it at any time. However, the current password must be active prior to disabling it. If the current password has

expired (more than 10 minutes have passed since your last keystroke), you must re-enter the current password before disabling it.

- 1 Press the  key.
- 2 Use the  key to scroll down until **Password** is highlighted.
- 3 Press the  key.
- 4 Use the  key to scroll down until **Disable Psw** is highlighted.
- 5 Press the  key to select **Disable Psw**.
- 6 If the current password is active, the menu displays **Password Is Now Disabled**. You can now make changes to parameters without any password.
- 7 If the current password has expired (more than 10 minutes have passed since your last keystroke), the menu displays **Failed, Password Not Active**. If this occurs, you must re-enter the current password and repeat this procedure.

ICIM	ICIM	ICIM
Shelf 7 Slot 15	Shelf 7 Slot 15	Shelf 7 Slot 15
User Psw	Enter Psw 8765****	Enter Psw 87654321
SA Psw		
Change Psw	Password Is Now Disabled	Failed, Password Not Active
Disable Psw	Shift Off	Shift Off

TP015

Operating the ICIM

Using the ICIM

Once the module is installed, it runs without the aid of an operator. Unless alarms are generated or your system configuration changes, you should not need to make any adjustments to the module beyond the initial setup.

To Access the ICIM LCD Contrast

To access the ICIM LCD contrast control from the MAIN menu, press the **ICIM** key. Use the **+** key to increase or the **-** key to decrease ICIM display contrast.

ICIM MAIN Menu

A few seconds after power-up, the MAIN menu appears. Press the **SEL** key to select the specific option.

Display	Description
Offline	Indicates status of communication between the ICIM and your network management system (TNCS/RS-485).
Modules	Indicates the number of modules in the ICIM domain.
Alarms	Displays the number of currently active alarms. Selecting this option allows scrolling through all modules in alarm condition.
Scroll	Allows scrolling through all modules in the ICIM domain.
Module Shelf Slot	Allows selection of any specific module in the ICIM domain.

ICIM MAIN Menu Illustration

The ICIM MAIN menu is shown below.

MAIN
Offline
Modules 15
Alarms 0
Scroll
Module Shelf Slot

TP011

Prisma II ICIM Menu

To display the ICIM menu, press the **ICIM** key. The ICIM menu appears. Press the **SEL** key to select the specific option.

Display	Description
Shelf Slot	Displays the location of the ICIM2 or ICIM2-XD.
Mfg Data	Displays manufacturing data about the ICIM2 or ICIM2-XD.
Password	Allows you to enter, change, or disable a system password. See Using the ICIM Password earlier in this chapter.
Update Adr	If the Chassis ID number switch has been changed, you must highlight the Update Adr menu and press the SEL key for the ICIM2 or ICIM2-XD to recognize the change.

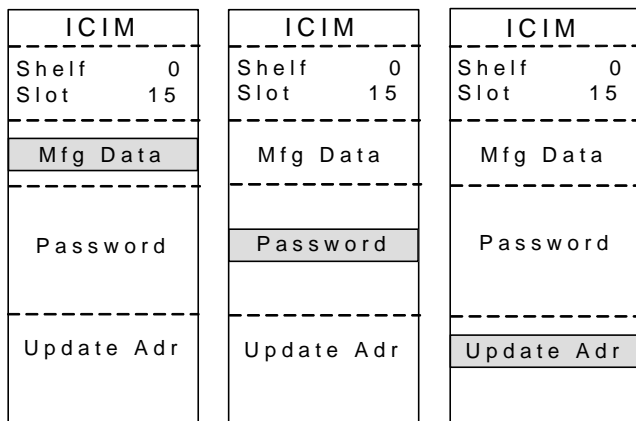

TP016

Prisma II MAIN Menu and ICIM Menu Structure

Pressing the **MAIN** key initiates the MAIN software menu. Pressing the **ICIM** key initiates the ICIM2 or ICIM2-XD software menu. The MAIN and ICIM software structures are shown below.

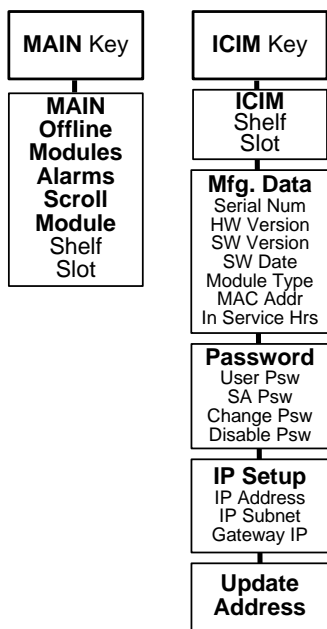

TP025

Receiver Software Menu Structure

From the MAIN or SCROLL menus, you can navigate to the MODULE menu. From the MODULE menu, press the **STAT**, **CFG**, or **ALRM** key to display the desired parameter menu.

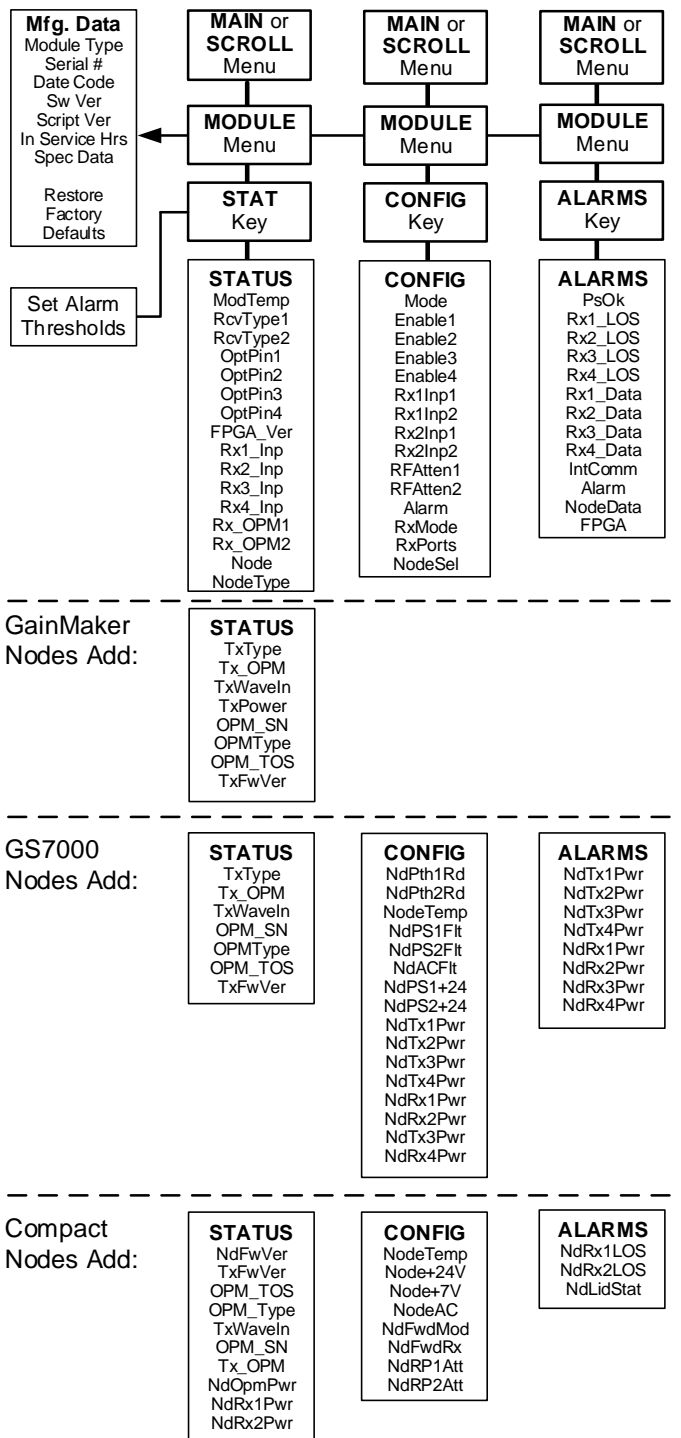













Note:

- As shown above, additional parameters appear in these menus depending on the type of node connected and node configuration.
- Due to space limitations, the CONFIG menus may display status indicators as well as configurable parameters.
- For details on all node parameters, see *Module Parameter Descriptions* (on page 141).

Checking the Operating Status using the ICIM

To Check the Operating Status using ICIM

You can use the ICIM to check the status of all operating parameters of this module. All status information is displayed on the ICIM LCD.

- 1 At the MAIN menu, press the  key to highlight the **Shelf** and **Slot** fields.
- 2 Press the  key to address the **Shelf** number. Then press the  key or the  key to scroll to the number of the desired shelf.
- 3 Press the  key. The **Slot** field is highlighted.
- 4 Press the  key or the  key to scroll to the number of the desired slot.
- 5 Press the  key. The **MODULE** menu appears on the ICIM LCD.
- 6 Press the  key.
- 7 Press the  key or the  key to scroll through the monitored parameters until you find the parameter of interest.
- 8 Check the status of the desired parameter or select other parameters to monitor.
When finished, press the  key to return to the **MAIN** menu.

STATUS Menus

Press the **STAT** key to select the STATUS menu. Typical STATUS menus are shown below.

<table border="1"> <thead> <tr><th colspan="2">STATUS</th></tr> </thead> <tbody> <tr><td>Shelf</td><td>5</td></tr> <tr><td>Slot</td><td>12</td></tr> <tr><td colspan="2">-----</td></tr> <tr><td colspan="2">P2-HD-QEDR -RX</td></tr> <tr><td colspan="2">-----</td></tr> <tr><td>ModTemp</td><td>36.5 degC</td></tr> <tr><td colspan="2">-----</td></tr> <tr><td>RcvType1</td><td>Ext</td></tr> <tr><td colspan="2">-----</td></tr> <tr><td>▲</td><td>▼</td></tr> </tbody> </table>	STATUS		Shelf	5	Slot	12	-----		P2-HD-QEDR -RX		-----		ModTemp	36.5 degC	-----		RcvType1	Ext	-----		▲	▼	<table border="1"> <thead> <tr><th colspan="2">STATUS</th></tr> </thead> <tbody> <tr><td>Shelf</td><td>5</td></tr> <tr><td>Slot</td><td>12</td></tr> <tr><td colspan="2">-----</td></tr> <tr><td colspan="2">P2-HD-QEDR -RX</td></tr> <tr><td colspan="2">-----</td></tr> <tr><td>RcvType2</td><td>Ext</td></tr> <tr><td colspan="2">-----</td></tr> <tr><td>OptPin1</td><td>-13.37 dBm</td></tr> <tr><td colspan="2">-----</td></tr> <tr><td>▲</td><td>▼</td></tr> </tbody> </table>	STATUS		Shelf	5	Slot	12	-----		P2-HD-QEDR -RX		-----		RcvType2	Ext	-----		OptPin1	-13.37 dBm	-----		▲	▼	<table border="1"> <thead> <tr><th colspan="2">STATUS</th></tr> </thead> <tbody> <tr><td>Shelf</td><td>5</td></tr> <tr><td>Slot</td><td>12</td></tr> <tr><td colspan="2">-----</td></tr> <tr><td colspan="2">P2-HD-QEDR -RX</td></tr> <tr><td colspan="2">-----</td></tr> <tr><td>OptPin2</td><td>-50.00 dBm</td></tr> <tr><td colspan="2">-----</td></tr> <tr><td>OptPin3</td><td>-50.00 dBm</td></tr> <tr><td colspan="2">-----</td></tr> <tr><td>▲</td><td>▼</td></tr> </tbody> </table>	STATUS		Shelf	5	Slot	12	-----		P2-HD-QEDR -RX		-----		OptPin2	-50.00 dBm	-----		OptPin3	-50.00 dBm	-----		▲	▼
STATUS																																																																				
Shelf	5																																																																			
Slot	12																																																																			

P2-HD-QEDR -RX																																																																				

ModTemp	36.5 degC																																																																			

RcvType1	Ext																																																																			

▲	▼																																																																			
STATUS																																																																				
Shelf	5																																																																			
Slot	12																																																																			

P2-HD-QEDR -RX																																																																				

RcvType2	Ext																																																																			

OptPin1	-13.37 dBm																																																																			

▲	▼																																																																			
STATUS																																																																				
Shelf	5																																																																			
Slot	12																																																																			

P2-HD-QEDR -RX																																																																				

OptPin2	-50.00 dBm																																																																			

OptPin3	-50.00 dBm																																																																			

▲	▼																																																																			
<table border="1"> <thead> <tr><th colspan="2">STATUS</th></tr> </thead> <tbody> <tr><td>Shelf</td><td>5</td></tr> <tr><td>Slot</td><td>12</td></tr> <tr><td colspan="2">-----</td></tr> <tr><td colspan="2">P2-HD-QEDR -RX</td></tr> <tr><td colspan="2">-----</td></tr> <tr><td>OptPin4</td><td>-50.00 dBm</td></tr> <tr><td colspan="2">-----</td></tr> <tr><td>FPGA_Ver</td><td>5.370</td></tr> <tr><td colspan="2">-----</td></tr> <tr><td>▲</td><td>▼</td></tr> </tbody> </table>	STATUS		Shelf	5	Slot	12	-----		P2-HD-QEDR -RX		-----		OptPin4	-50.00 dBm	-----		FPGA_Ver	5.370	-----		▲	▼	<table border="1"> <thead> <tr><th colspan="2">STATUS</th></tr> </thead> <tbody> <tr><td>Shelf</td><td>5</td></tr> <tr><td>Slot</td><td>12</td></tr> <tr><td colspan="2">-----</td></tr> <tr><td colspan="2">P2-HD-QEDR -RX</td></tr> <tr><td colspan="2">-----</td></tr> <tr><td>Rx1_Inp</td><td>Both On</td></tr> <tr><td colspan="2">-----</td></tr> <tr><td>Rx2_Inp</td><td>Both On</td></tr> <tr><td colspan="2">-----</td></tr> <tr><td>▲</td><td>▼</td></tr> </tbody> </table>	STATUS		Shelf	5	Slot	12	-----		P2-HD-QEDR -RX		-----		Rx1_Inp	Both On	-----		Rx2_Inp	Both On	-----		▲	▼	<table border="1"> <thead> <tr><th colspan="2">STATUS</th></tr> </thead> <tbody> <tr><td>Shelf</td><td>5</td></tr> <tr><td>Slot</td><td>12</td></tr> <tr><td colspan="2">-----</td></tr> <tr><td colspan="2">P2-HD-QEDR -RX</td></tr> <tr><td colspan="2">-----</td></tr> <tr><td>Rx3_Inp</td><td>Both On</td></tr> <tr><td colspan="2">-----</td></tr> <tr><td>Rx4_Inp</td><td>Both On</td></tr> <tr><td colspan="2">-----</td></tr> <tr><td>▲</td><td>▼</td></tr> </tbody> </table>	STATUS		Shelf	5	Slot	12	-----		P2-HD-QEDR -RX		-----		Rx3_Inp	Both On	-----		Rx4_Inp	Both On	-----		▲	▼
STATUS																																																																				
Shelf	5																																																																			
Slot	12																																																																			

P2-HD-QEDR -RX																																																																				

OptPin4	-50.00 dBm																																																																			

FPGA_Ver	5.370																																																																			

▲	▼																																																																			
STATUS																																																																				
Shelf	5																																																																			
Slot	12																																																																			

P2-HD-QEDR -RX																																																																				

Rx1_Inp	Both On																																																																			

Rx2_Inp	Both On																																																																			

▲	▼																																																																			
STATUS																																																																				
Shelf	5																																																																			
Slot	12																																																																			

P2-HD-QEDR -RX																																																																				

Rx3_Inp	Both On																																																																			

Rx4_Inp	Both On																																																																			















▲	▼																																																																			

Note: For details on all operating status parameters, see *Module Parameter Descriptions* (on page 141).

Configuring the Module using the ICIM

To Configure Parameters using the ICIM

You can use the ICIM to configure the parameters of this module.

- 1 From the **MAIN** menu, press the  key to highlight the **Shelf** and **Slot** fields.
- 2 Press the  key to address the **Shelf** number. Then press the  key or the  key to scroll to the number of the desired shelf.
- 3 Press the  key. The **Slot** field is highlighted.
- 4 Press the  key or the  key to scroll to the number of the desired slot.
- 5 Press the  key. The **MODULE** menu appears on the ICIM LCD.
- 6 To configure the module, press the  key.
- 7 Press the  key or the  key to scroll through the configurable controls until you find the parameter of interest.
- 8 Press the  key to select the highlighted control.
- 9 Press the  key or the  key to activate or change the value of the selected control.
- 10 Press the  key to save the changes and return to the **MAIN** menu.

Alarm Threshold Menus

Some typical alarm threshold menus are shown below.

STATUS		STATUS	
Shelf	5	Shelf	5
Slot	12	Slot	12
P2-HD-QEDR		P2-HD-QEDR	
-RX		-RX	
Rx1_LOS		Rx2_LOS	
MajH-18dB		MajH-18dB	
MinH-15dB		MinH-15dB	
MinL-10dB		MinL-10dB	
MajL-8 dB		MajL-8 dB	
▲ ▼		▲ ▼	

Note: For details on all alarm thresholds, see *Module Parameter Descriptions* (on page 141).

CONFIG Menus

When the **CONFIG** menu is selected, the **Shelf** number field is highlighted. The shelf and slot number fields may only be incremented with the key or the key. The key highlights the **Slot** number field. Once you exit the slot

field, the Up and Down arrows will scroll through the parameters that are specific to this module.

Sample **CONFIG** menus are shown below.

CONFIG	CONFIG	CONFIG
Shelf 5 Slot 12	Shelf 5 Slot 12	Shelf 5 Slot 12
P2-HD-QEDR -RX	P2-HD-QEDR -RX	P2-HD-QEDR -RX
Mode Enable1 Enable2 Enable3 Enable4	Rx1Inp1 Rx1Inp2 Rx2Inp1 Rx2Inp2 RFAtten1	RFAtten2 Alarm RxMode RxPorts NodeSel
▲ ▼	▲ ▼	▲ ▼

Note: For details on all configurable parameters, see *Module Parameter Descriptions* (on page 141).













Checking Alarms using the ICIM

To Check Alarms using ICIM

Alarms fall into one of the following categories.









- Major low
- Minor low
- Minor high
- Major high
- Boolean

If the red ALARM LED on the front panel is blinking, a minor alarm condition is indicated. If the ALARM LED on the front panel is illuminated, a major alarm conditions is indicated.

- 1 From the MAIN menu, press the  key to highlight the **Shelf** and **Slot** fields.
- 2 Press the  key to address the **Shelf** number. Then press the  key or the  keys to scroll to the number of the desired shelf.
- 3 Press the  key.
Result: The **Slot** field is highlighted.
- 4 Press the  key or the  key to Scroll to the number of the desired slot.
- 5 Press the  key.
Result: The **MODULE** menu displays on the ICIM.
- 6 Press the  key.
Result: Module alarm conditions display.
- 7 Use the  key or the  key to scroll through alarm conditions until the desired alarm is displayed.
- 8 Monitor the alarm condition(s). Take appropriate action. Verify that all settings and thresholds relating to the alarm indication are set correctly to rule out an unintended alarm.
- 9 When finished, press the  key to return to the MAIN menu.

ALARMS Menus

When a module **ALARMS** menu is selected, press the  key or the  key to scroll through alarms. Some typical **ALARMS** menus are shown below.

ALARMS	ALARMS	ALARMS	ALARMS
Shelf 5 Slot 12	Shelf 5 Slot 12	Shelf 5 Slot 12	Shelf 5 Slot 12
P2-HD-QEDR -RX	P2-HD-QEDR -RX	P2-HD-QEDR -RX	P2-HD-QEDR -RX
Rx1_LOS Fault	Rx2_LOS Fault	Rx1_Data Fault	Rx2_Data Fault
 	 	 	 

Note: For details on all alarm parameters, see *Module Parameter Descriptions* (on page 141).

To Set Adjustable Alarm Thresholds using the ICIM

You can use the ICIM to change the adjustable alarm thresholds of this module from their factory default values.









- 1 At the MODULE menu, press the **STAT** key. The STATUS menu appears on the ICIM LCD.
- 2 Press the **SEL** key. The alarm thresholds previously set are displayed. If the label **n/a** is displayed, you cannot configure that alarm threshold. Press the **▼** key to highlight the alarm threshold for the next parameter.
- 3 When the threshold that you wish to set is highlighted, press the **ENTER** key.
- 4 Press the **▼** key or the **▲** key to change the increment size.
- 5 Press the **+** key or the **-** key to adjust the alarm threshold.
Note: Press the Cancel (**ALRM**) key to return to the previous menu.
- 6 Press the **ENTER** key to save the changes. The message **Data Saved** appears on the ICIM LCD.
- 7 When finished, press the **MAIN** key to return to the MAIN menu.

Checking Manufacturing Data using the ICIM

To Check Manufacturing Data

You can display the manufacturing data for this module on the ICIM LCD.



Complete the following steps to access the manufacturing data.









- 1 From the MAIN menu, press the  key to highlight the **Shelf** and **Slot** fields.
- 2 Press the  key to address the **Shelf** number. Then press the  key or the  key to scroll to the number of the desired shelf.
- 3 Press the  key. The **Slot** field is highlighted.
- 4 Press the  key or the  key to scroll to the number of the desired slot.
- 5 Press the  key. The MODULE menu for this module will be selected, as shown on the left below. Press the  key to enter the start of the MFG. DATA menus, as shown on the right below.

MODULE	MFG. DATA
Shelf 5 Slot 12	Shelf 5 Slot 12
P2-HD-QEDR -RX	P2-HD-QEDR -RX
Alarms 1	Module Type
Mfg. Data	2041
▲ ▼	▲ ▼

Use the  and  keys to scroll through the manufacturing data.

MFG. DATA Menus

When the **MFG. DATA** menu is selected, the  key or the  key allows you to scroll through the manufacturing parameters specific to this module. Sample **MFG. DATA** menus are shown below.

MFG. DATA	MFG. DATA	MFG. DATA	MFG. DATA	MFG. DATA
Shelf 5 Slot 12	Shelf 5 Slot 12	Shelf 5 Slot 12	Shelf 5 Slot 12	Shelf 5 Slot 12
P2-HD-QEDR -RX	P2-HD-QEDR -RX	P2-HD-QEDR -RX	P2-HD-QEDR -RX	P2-HD-QEDR -RX
Module Type 2041	Serial # ^ABCDEFGF	Sw Ver CF_CCB3	In Service Hours 19	Restore Factory Defaults
	Date Code A07	Script Ver N/A	Spec Data	
 	 	 	 	

Note: For details on all manufacturing data parameters, see *Module Parameter Descriptions* (on page 141).

Saving the Configuration using the ICIM

To Save the Current Configuration

- 1 After you have changed a parameter or entered data, press the **ENTER** key to save the changes and return to the MAIN menu. The ICIM will report "SUCCESS" if the changes were accepted.
- 2 If you do not save your changes for two minutes, or if you press the **SHIFT** **CAN** keys at the same time, changes are aborted and the display returns to the MAIN menu.

Configuration Complete

If no alarms are indicated after using the ICIM to configure this module to your system specifications, no further action is necessary. The module operates without further input. Alarms, changes in operating parameters, electrical power fluctuations, or changes in system design may be cause for additional action.

Adjusting Alarm Thresholds

To Adjust Alarm Thresholds

Relative alarm thresholds are both displayed and stored as relative values. This method for adjusting alarm thresholds lets you choose any valid increment size and adjust the alarm threshold to any valid value.

You can use the ICIM to change the adjustable alarm thresholds of this module from their factory default values.

- 1 At the MODULE menu, press the **STAT** key. The STATUS menu appears on the ICIM LCD.
- 2 Press the **SEL** key. The alarm thresholds previously set are displayed. If the label **n/a** is displayed, you cannot configure that alarm threshold. Press the **▼** key to highlight the alarm threshold for the next parameter.
- 3 When the threshold that you wish to set is highlighted, press the **ENTER** key.
- 4 Press the **▼** key or the **▲** key to change the increment size.
- 5 Press the **+** key or the **-** key to adjust the alarm threshold.
Note: Press the Cancel (**ALRM**) key to return to the previous menu.
- 6 Press the **ENTER** key to save the changes. The message **Data Saved** appears on the ICIM LCD.
- 7 When finished, press the **MAIN** key to return to the MAIN menu.

4

Operation using LCI

Introduction

This chapter provides instructions for installing and using the LCI. This chapter applies if you are using the LCI to operate a module.

In This Chapter

■ LCI Introduction	108
■ System Requirements	109
■ Installing LCI	110
■ Connecting Your Computer to the Chassis	114
■ Starting LCI Software	116
■ LCI Module Tree	118
■ Accessing the Module Detail Information	119
■ Checking the Operating Status	122
■ Configuring the Module using LCI	124
■ Checking the Module Alarms using LCI	126
■ Modifying Module Alarm Limits using LCI	128
■ Checking Manufacturing Data using LCI	130

LCI Introduction

LCI Function

LCI is software that functions as a user interface for the Prisma II platform. LCI is installed on a computer, which is then connected to a Prisma II Chassis. Using LCI, you can configure and monitor the modules in the chassis to which the computer is connected.

Important: Do not operate any Prisma II Chassis without a fan tray installed. If a fan tray is not installed in the Prisma II Chassis, the LCI will not communicate with any of the power supplies in that chassis.

System Requirements

You will need the following computer software and hardware to run LCI.

Computer Requirements

- Pentium II 300 MHz processor or equivalent
- 128 MB RAM
- 10 MB available hard drive space
- CD-ROM Drive
- Windows 95 or later operating system software

Cable Requirements

The required cable is a standard serial extension cable, DB9 Female to DB9 Male. This cable can be purchased locally or ordered from the factory as part number 180143. The connectors are a serial 9-pin D-shell (EIA 574/232).

Installing LCI

This section describes how to install your LCI software.

To Install the LCI Software

Complete the following steps to install the LCI software.

- 1 Obtain the LCI installation program from www.cisco.com/support and copy the program file to your Windows desktop.

Note: If you need help locating the LCI installation program, contact Cisco Services at 1-800-283-2636 for assistance.

- 2 Launch the LCI installation program. The Welcome screen appears as shown in the following illustration.

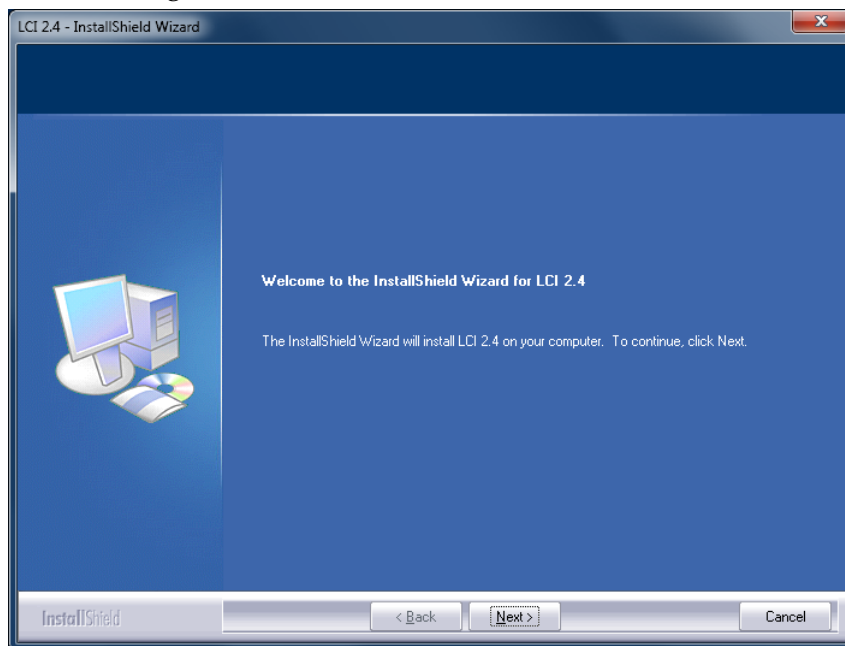

- 3 Click **Next** to continue with the installation process. The Ready to Install the Program screen appears as shown in the following illustration.

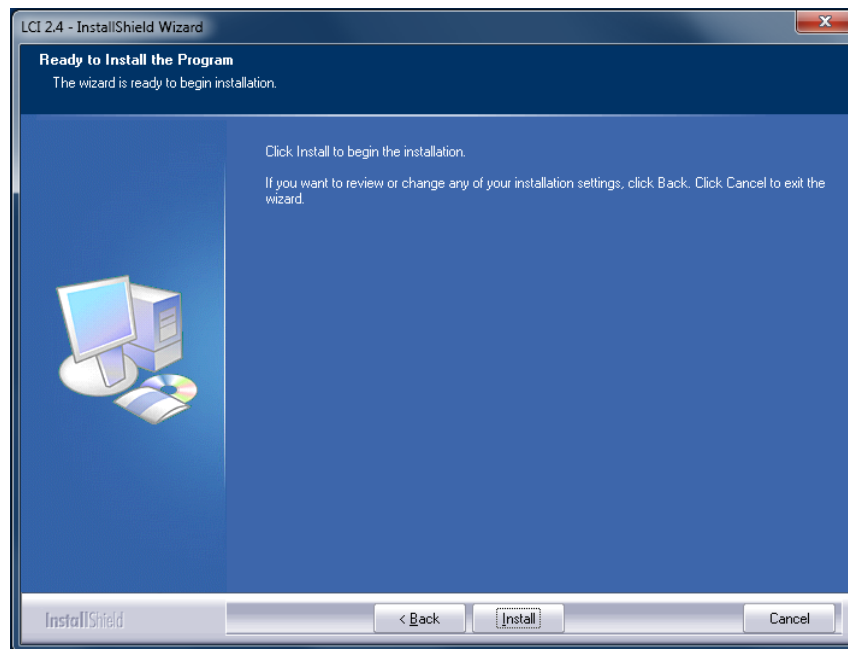

- 4 Click **Install** to begin installation. After a moment, the Setup Status screen appears, displaying a progress indicator as shown in the following illustration.

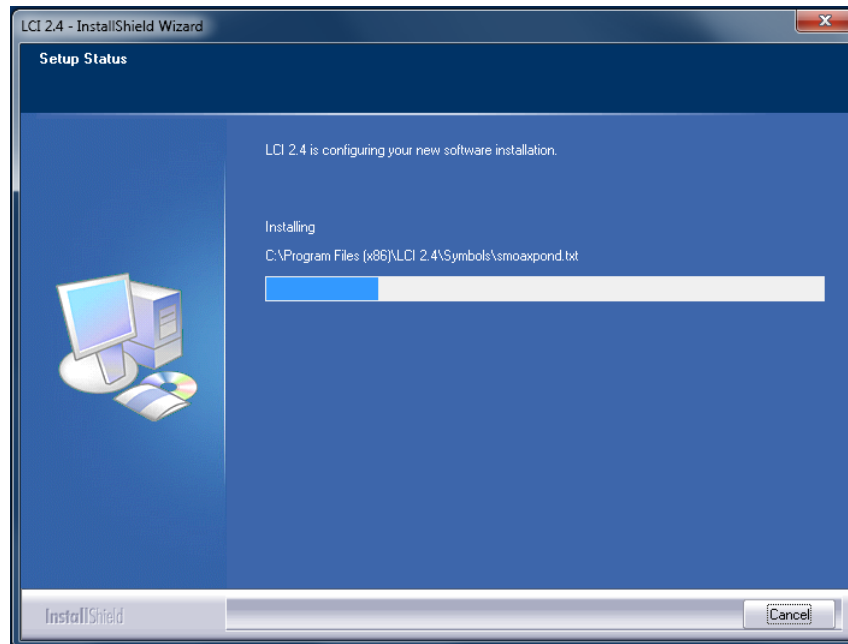

- 5 When finished, the "wizard" asks if you want to install the Silicon Labs driver, which is required when using LCI with a node product.
 - If you are using LCI with a node product, choose the **Launch** option, click **Next**, and follow steps of the wizard to install the driver.
 - If you are not using LCI with a node product, choose the **Exit Installation** option and then click **Next**.

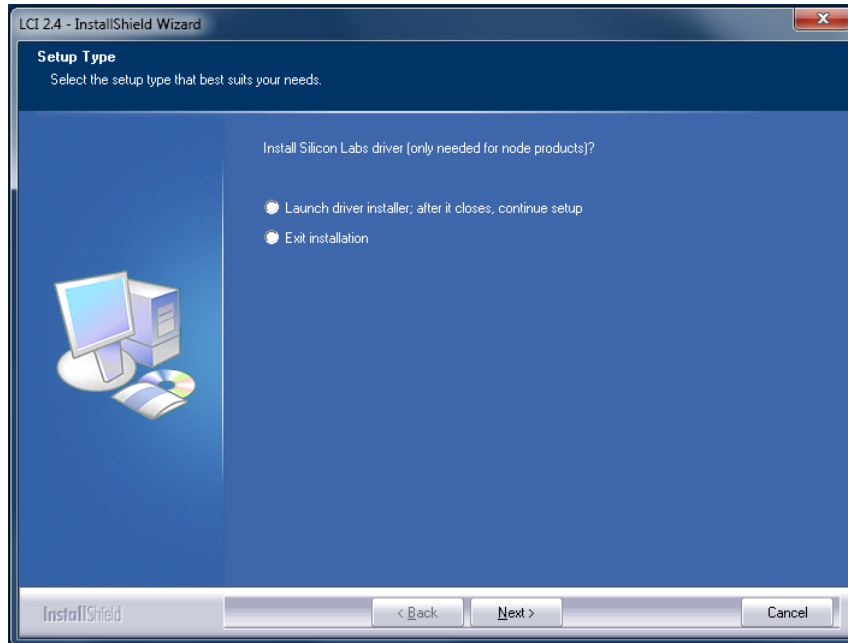

- 6 When finished, the InstallShield Wizard Complete screen appears as shown in the following illustration.

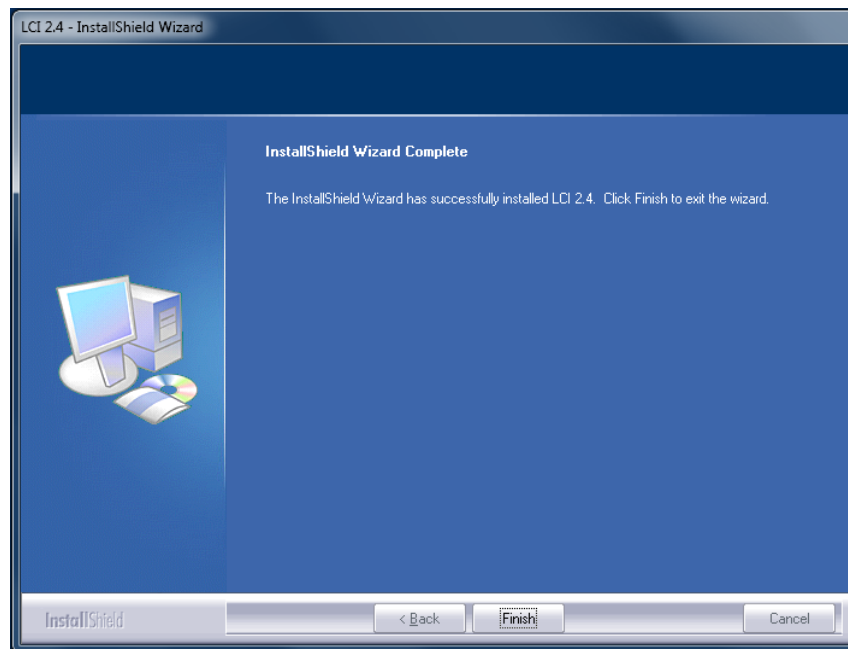

- 7 Click **Finish** to exit the Install wizard. An LCI shortcut is placed on your Windows desktop as shown in the following illustration.



The LCI software is now ready to use.

Connecting Your Computer to the Chassis

Before you start LCI, you must first connect your computer to the chassis that contains the module(s) you want to check.

Important:

- LCI only communicates with modules installed in the chassis to which your computer is connected. To check other modules, you must connect your computer to the chassis in which they are installed.
- If LCI does not communicate with a module in the chassis to which your computer is connected, it may be necessary to update the LCI application.

To Connect a Computer to the Chassis

Complete the following steps to connect your computer to the chassis.

- 1 Plug one end of a 9-pin RS-232 serial extension cable into your computer.
- 2 Plug the other end of the cable into the LCI port, labeled **Local Craft Interface**.

Standard Prisma II Chassis

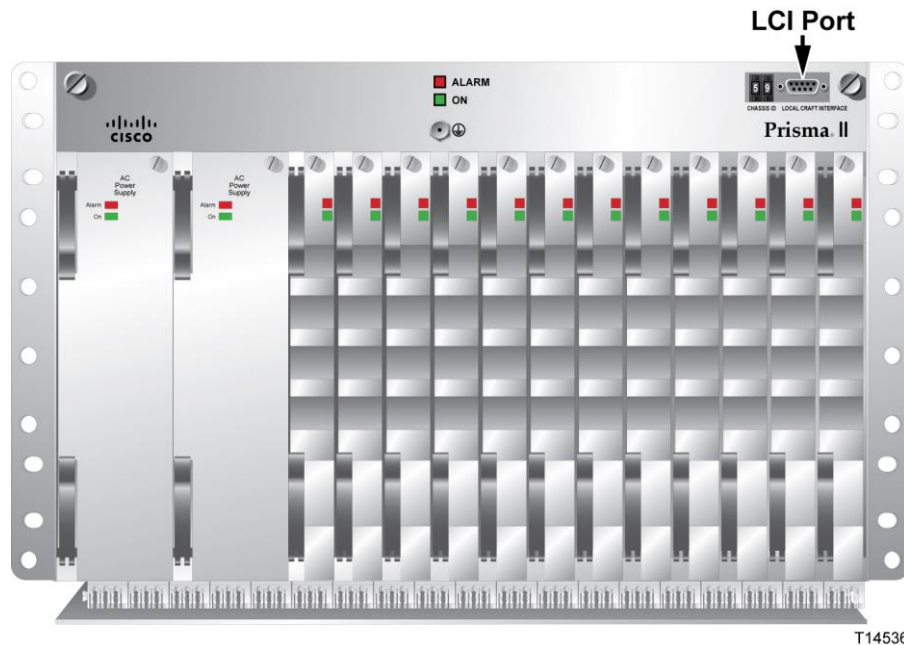

Prisma II XD Chassis (Top Right Corner Detail)

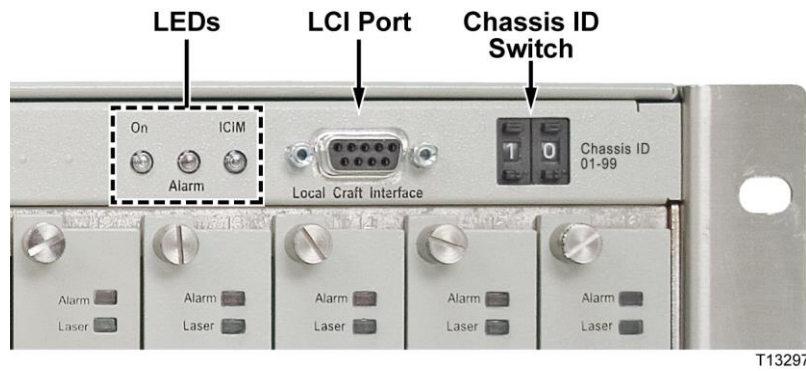

T13297

Starting LCI Software

When you start LCI, it polls the module(s) located in the chassis to which your computer is attached. For each module it finds, LCI does the following:

- Represents the module in the module tree of the main LCI window
- Makes the polling information available so you can check and configure various parameters

Important: Your computer must be connected to the chassis before you start LCI. For instructions, refer to *Connecting Your Computer to the Chassis* (on page 114).

To Start LCI Software

Complete the following steps to start the LCI software.

- 1 Double-click the LCI icon on your Windows desktop.



Result: The LCI Detect Configuration window appears as shown below.

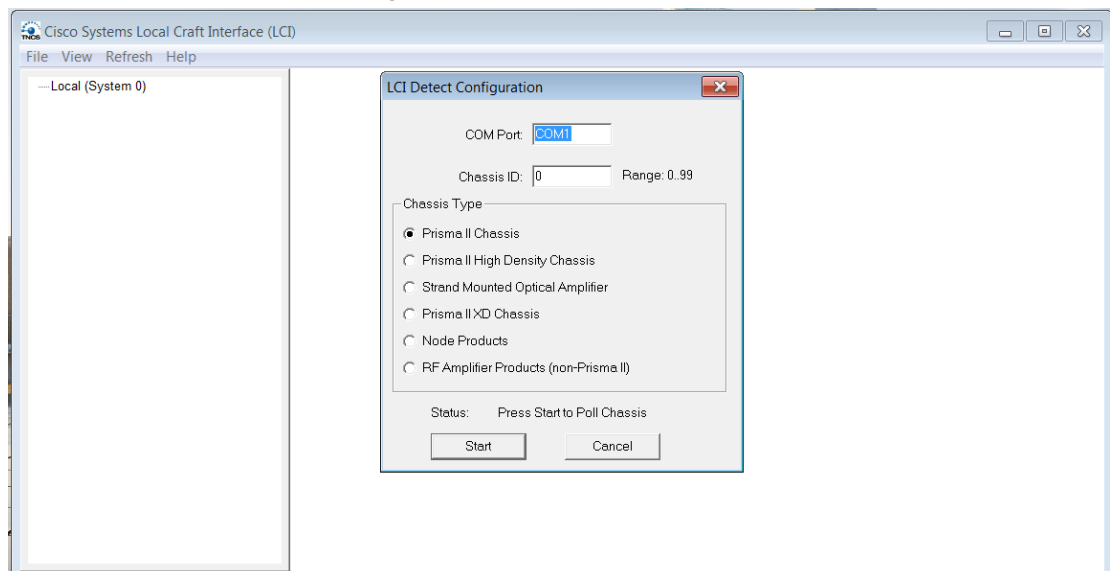

- 2 In the LCI Detect Configuration window, select the appropriate COM port, chassis ID, and chassis type, and then click **Start**.

Result: LCI polls the modules in the chassis, and when finished, displays a Refresh Complete message.

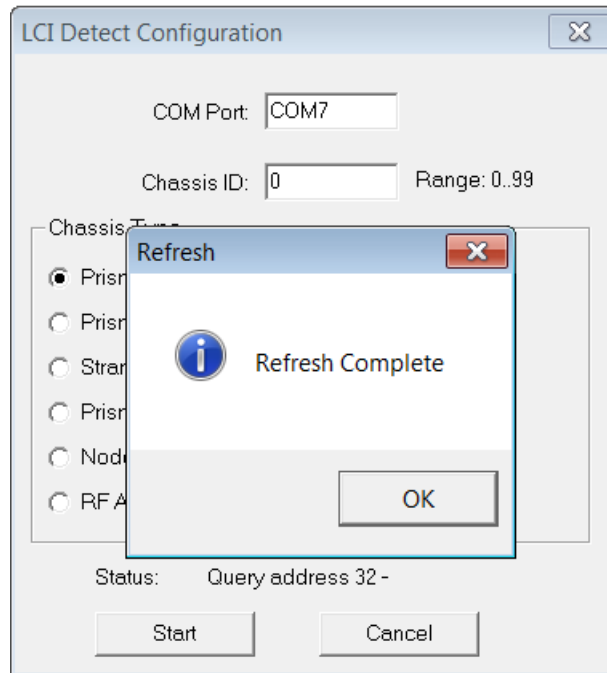

- 3 Click **OK** to continue with LCI startup.

Result: The main LCI window appears as shown in the example below.

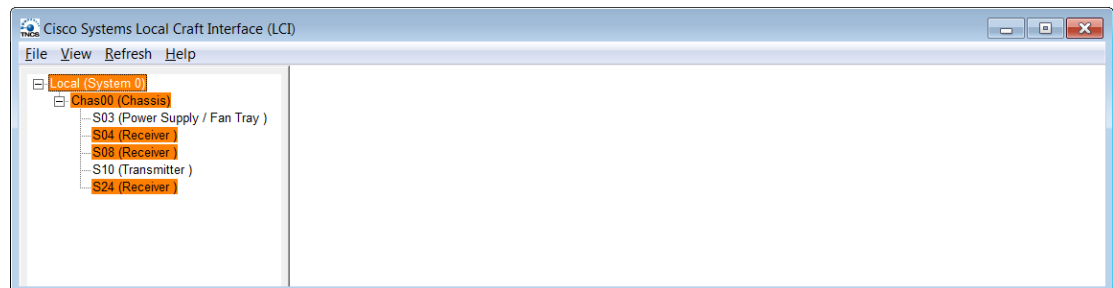

LCI Module Tree

The LCI main window contains a tree that represents your system in a hierarchical manner.

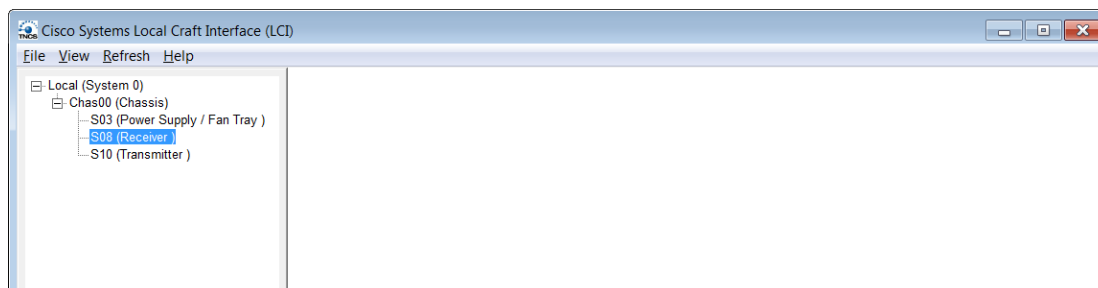

Note: You may need to refresh the module tree once the node is unplugged from your system due to the loss of connection.

Module Tree

The module tree represents a computer connected to a chassis that contains five modules. The three tree levels are described in the following table.

Module Tree Level	Description
Local (System 0)	Computer being used
Chass00 (Chassis)	Chassis the computer is connected to
Sxx (Module name)	<p>Module(s) located within the chassis. Each module is of the format <i>chassis slot location (module name)</i>.</p> <p>Slot location is from 17-32 if the module is located at the lower slot of the host module. The slot number will be the regular upper slot number plus 16.</p> <p>Example: In the module tree graphic, S24 (Receiver) represents a receiver located in slot 24 of the chassis (lower half of slot 8).</p>

Accessing the Module Detail Information

The Module Details window displays information about module parameters, alarms, and status. You can access this window from the module tree using any of these methods:

- Double-click the chassis and select the module in the graphic that appears.
- Right-click the chassis and select **Open** from the menu that appears.
- Double-click the module.
- Right-click the module and select **Details** from the menu that appears.

You can use the method most convenient for you. The procedures throughout this section are described using the right-click module technique.

Note: Two items that may appear in the Module Details window are mode-specific. Manual Alarm status only appears in the Controls section when Master mode is selected. Relay status only appears in the Status section when Slave mode is selected.

Module Details Window

The Module Details window displays slightly different information depending on the module operating mode.

- In Single mode, the Module Details screen window appears as shown in the

following example.

QEDR Receiver

Present Value	Present Status	Minor-Alarm Low-Limit	Minor-Alarm High-Limit	Major-Alarm Low-Limit	Major-Alarm High-Limit	
Optical Input 1	-14.9	Normal	-18.0	-10.0	25.0	-8.0 dBm
Optical Input 2	-16.3	Normal	-18.0	-10.0	25.0	-8.0 dBm
Optical Input 3	-16.4	Normal	-18.0	-10.0	25.0	-8.0 dBm
Optical Input 4	-15.9	Normal	-18.0	-10.0	25.0	-8.0 dBm

Alarms
 Summary Status Normal
 Communication Status Normal

Rx-Alarms
 Power Supply Status Normal
 Rx 1 Loss Of Data Normal
 Rx 2 Loss Of Data Normal
 Rx 3 Loss Of Data Normal
 Rx 4 Loss Of Data Normal
 Internal Communication Status Normal
 Forced Alarm Status Normal
 Node Data Valid Normal

Rx-Status
 Module Temperature 35.9 deg-C
 Receiver 1 Type Ext
 Receiver 2 Type Ext
 FPGA FW Version 5.37
 Rx Input 1 RF Both-on
 Rx Input 2 RF Both-on
 Rx Input 3 RF Both-on
 Rx Input 4 RF Both-on
 Rx OPM 1 Compliant Yes
 Rx OPM 2 Compliant Yes
 Node Set 1
 Node Type Unknown

Rx-Controls
 Mode Select Single
 Enable 1 On
 Enable 2 On
 Enable 3 On
 Enable 4 On
 Rx Input 1 Enable Both-on
 Rx Input 2 Enable Both-on
 Rx Input 3 Enable Both-on
 Rx Input 4 Enable Both-on
 RF Atten 1 0.0 dB
 RF Atten 2 0.0 dB
 Rx Mode 5G
 RF Ports 1
 Node Select 1

Node-Data
 Tx OPM Compliant Yes
 Tx Wavelength 1546.92 nm
 Tx Power 5.99 dBm
 Tx OPM Serial Number 34576
 Tx OPM Type CWDM
 Tx Type 2.1
 Tx FW Version 0.26
 Tx OPM TOS 156 hrs

Properties
 DevType Revision 1.06
 Name S08
 Graphic
 Service Name
 Symbol
 Device Location
 Alias
 Notify Set A
 Notify Set B
 M&C-Scan On Scan
 Maintenance Mode Normal
 Poll Counter 130
 Script
 Comm Alarm Threshold 1
 Comm Quality %
 Address 8
 Port COM7
 Description QEDR Receiver
 Software Revision 1.00.35
 Script Version N/A
 Serial Number *ABCDEFG
 Time Of Service 216 Hrs
 Date Code A14
 Module Type 2042

- If the module is changed to Master mode, an additional Manual Alarm control appears at the bottom of the Controls table, as shown in the following example:

QEDR Receiver

Present Value	Present Status	Minor-Alarm Low-Limit	Minor-Alarm High-Limit	Major-Alarm Low-Limit	Major-Alarm High-Limit	
Optical Input 1	-14.9	Normal	-18.0	-10.0	25.0	-8.0 dBm
Optical Input 2	-16.3	Normal	-18.0	-10.0	25.0	-8.0 dBm
Optical Input 3	-16.5	Normal	-18.0	-10.0	25.0	-8.0 dBm
Optical Input 4	-15.9	Normal	-18.0	-10.0	25.0	-8.0 dBm

Alarms
 Summary Status Normal
 Communication Status Normal

Rx-Alarms
 Power Supply Status Normal
 Rx 1 Loss Of Data Normal
 Rx 2 Loss Of Data Normal
 Rx 3 Loss Of Data Normal
 Rx 4 Loss Of Data Normal
 Internal Communication Status Normal
 Forced Alarm Status Normal
 Node Data Valid Normal

Rx-Status
 Module Temperature 36.4 deg-C
 Receiver 1 Type Ext
 Receiver 2 Type Ext
 FPGA FW Version 5.37
 Rx Input 1 RF Both-on
 Rx Input 2 RF Both-on
 Rx Input 3 RF Both-on
 Rx Input 4 RF Both-on
 Rx OPM 1 Compliant Yes
 Rx OPM 2 Compliant Yes
 Node Set 1
 Node Type Unknown

Rx-Controls
 Mode Select Master
 Enable 1 On
 Enable 2 On
 Enable 3 On
 Enable 4 On
 Rx Input 1 Enable Both-on
 Rx Input 2 Enable Both-on
 Rx Input 3 Enable Both-on
 Rx Input 4 Enable Both-on
 RF Atten 1 0.0 dB
 RF Atten 2 0.0 dB
 Manual Alarm Off
 Rx Mode 5G
 RF Ports 1
 Node Select 1

Node-Data
 Tx OPM Compliant Yes
 Tx Wavelength 1546.92 nm
 Tx Power 5.99 dBm
 Tx OPM Serial Number 34576
 Tx OPM Type CWDM
 Tx Type 2.1
 Tx FW Version 0.26
 Tx OPM TOS 156 hrs

Properties
 DevType Revision 1.06
 Name S08
 Graphic
 Service Name
 Symbol
 Device Location
 Alias
 Notify Set A
 Notify Set B
 M&C-Scan On Scan
 Maintenance Mode Normal
 Poll Counter 183
 Script
 Comm Alarm Threshold 1
 Comm Quality %
 Address 8
 Port COM7
 Description QEDR Receiver
 Software Revision 1.00.35
 Script Version N/A
 Serial Number *ABCDEFG
 Time Of Service 216 Hrs
 Date Code A14
 Module Type 2042

To Access the Module Details, Right-Click the Module

- 1 Right-click the module, and then click **Details**.

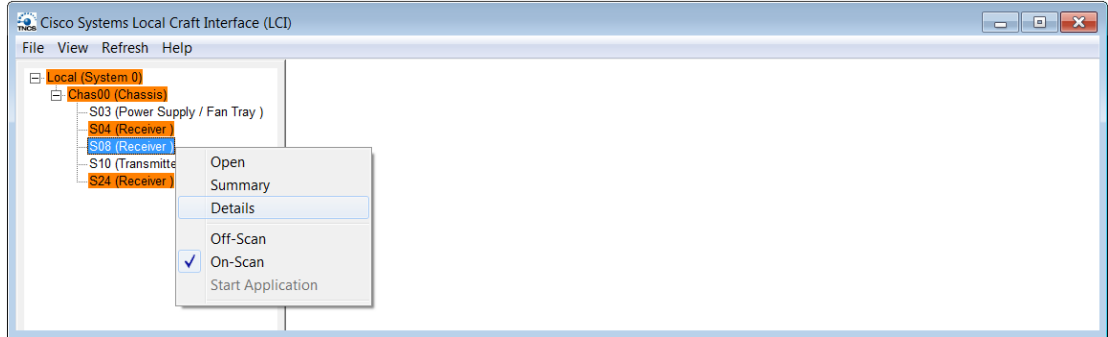

Result: The Module Details window appears.

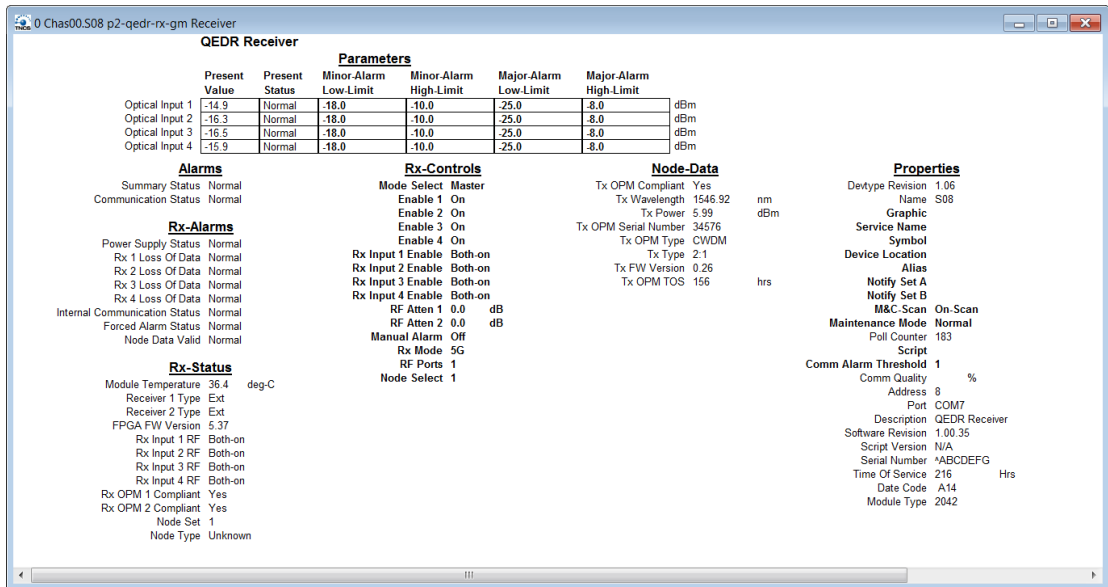

- 2 Proceed with viewing or configuring information.

Checking the Operating Status

To Check Operating Status using LCI

Using the LCI, you can check the status of all module operating parameters.

- 1 In the module tree, right-click the module, and then click **Details**.

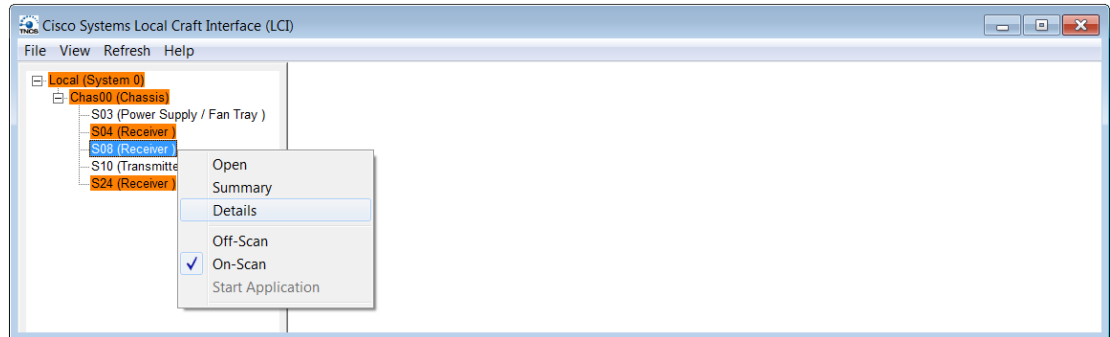

The Module Details window appears as shown in the following example. The monitored parameters are displayed under **Parameters** and **Status**.

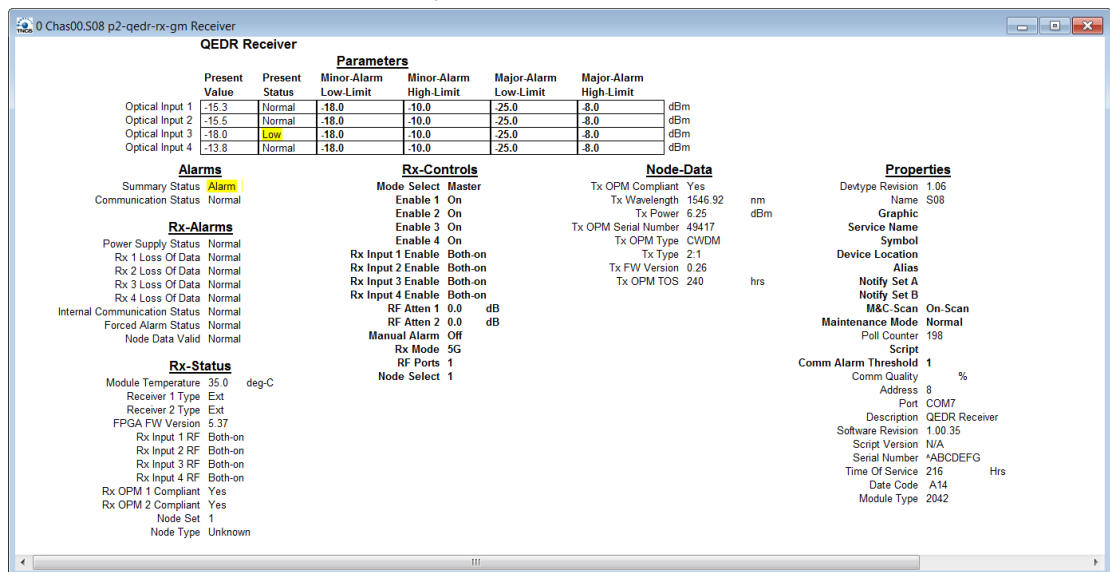

- 2 Check the operating parameters.

Note:

- The Communication Status parameter is reported by the LCI to indicate communication status with the module. For help with any problems indicated here, see *Troubleshooting Alarm Conditions* (on page 134).
- For details on all operating status parameters, see *Module Parameter Descriptions* (on page 141).

Configuring the Module using LCI

To Configure Parameters using LCI

Using LCI, you can configure any module parameters that allow for such changes.

- 1 In the module tree, right-click the module, and then click **Details**.

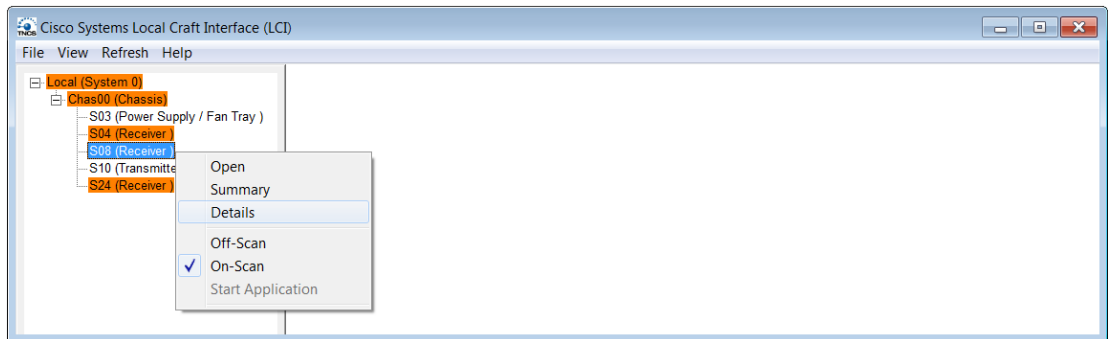

The Module Details window appears as shown in the following example.

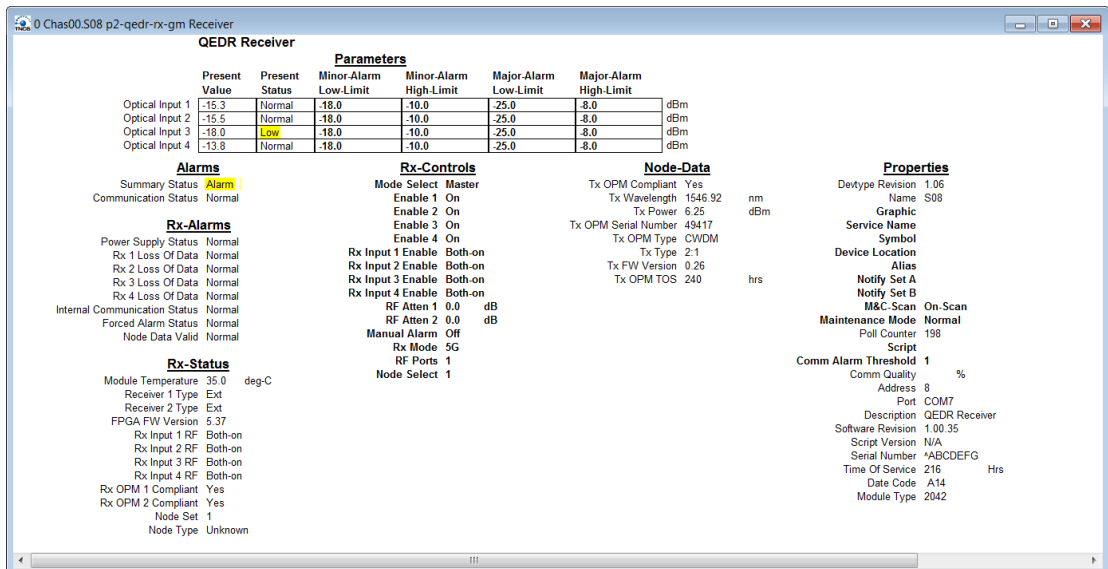

- 2 Under **Controls**, double-click the parameter you want to configure. The Change Value Dialog box appears. This example shows the dialog box for the RF Atten 1 parameter.

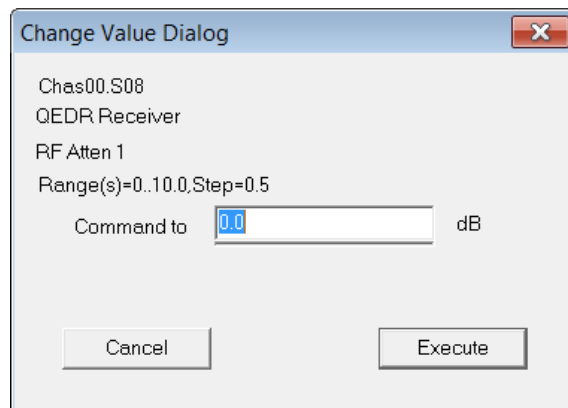

- 3 Depending on the parameter you chose, select or type a new value.
- 4 Click **Execute**. The new value appears next to the parameter.

Note: For details on all configurable parameters, see *Module Parameter Descriptions* (on page 141).

Checking the Module Alarms using LCI

Using LCI, you can check the alarm status of various parameters. Alarms limits fall into one of the following categories.

- Major low
- Minor low
- Minor high
- Major high

To Check Alarms using LCI

Right-click the module, and then click **Details**.

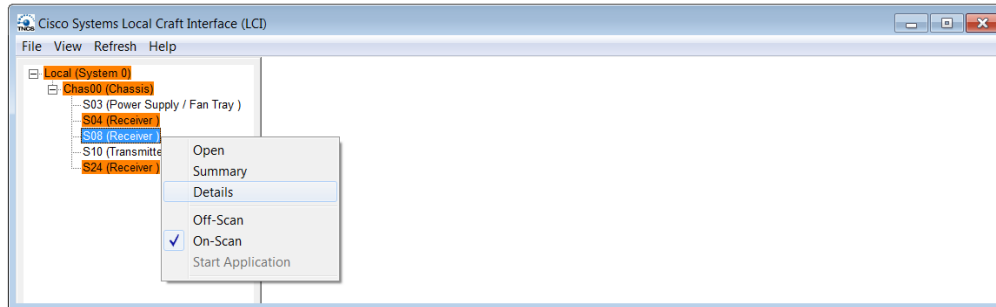

The Module Details window appears as shown in the following example. The alarms are shown under **Parameters** and **Alarms**.

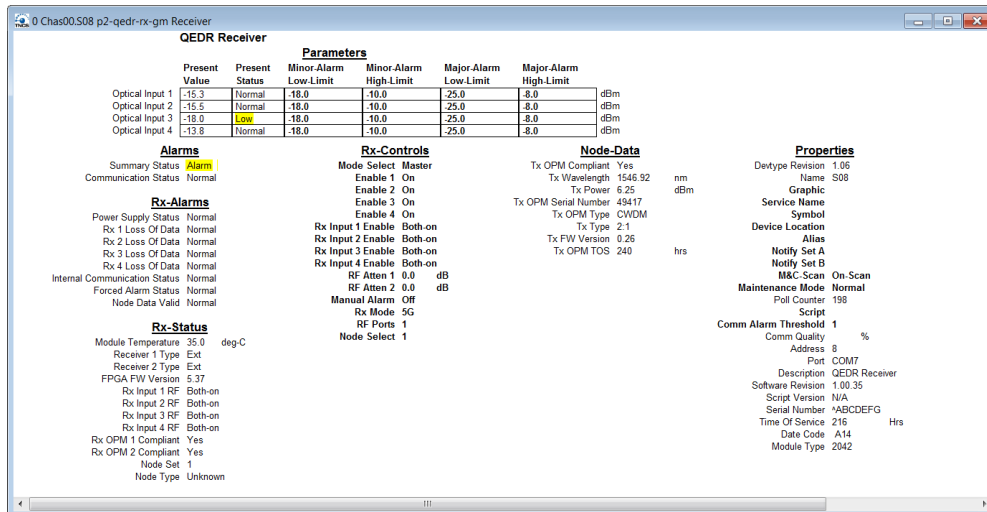

Note: For details on all alarm parameters, see *Module Parameter Descriptions* (on page 141).

Modifying Module Alarm Limits using LCI

To Modify Alarm Limits using LCI

Using LCI, you can modify alarm limits for parameters that allow for such changes.

- 1 In the module tree, right-click the module, and then click **Details**.

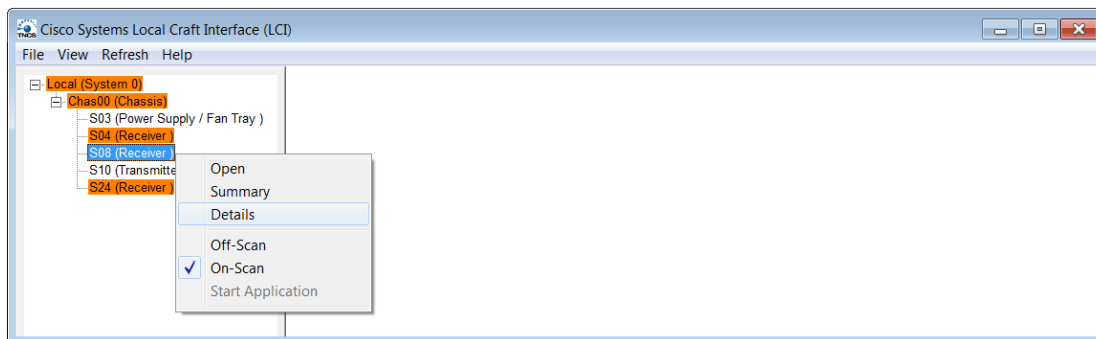

The Module Details window appears as shown in the following example. The alarm limits are shown under **Parameters**.

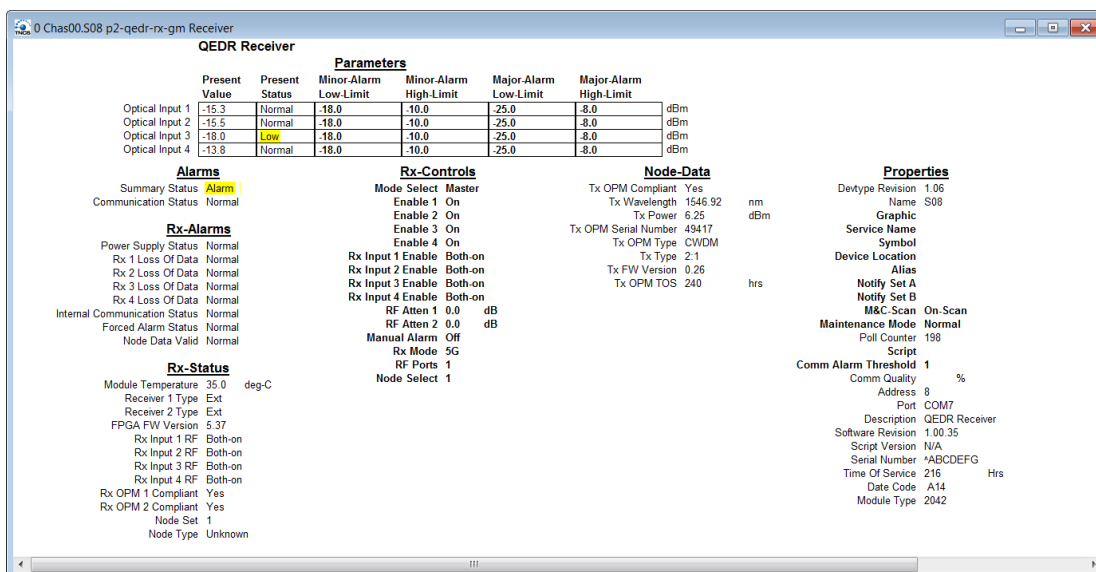

- 2 Double-click the limit you want to change. This example shows a Change Value dialog box for the Optical Input 1 Minor Low Limit parameter.

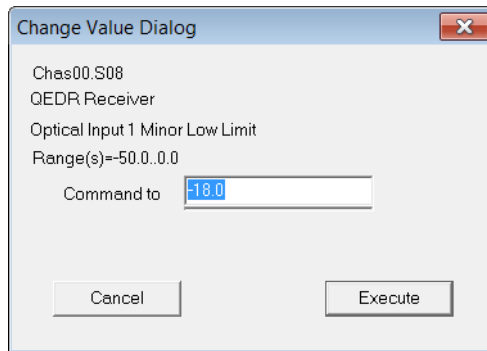

- 3 To change the limit value, type the desired value in the **Command to** box.
- 4 Click **Execute**. The new value appears in the alarm limit column.

Note: For details on all alarm limits, see *Module Parameter Descriptions* (on page 141).

Checking Manufacturing Data using LCI

To Check Manufacturing Data using LCI

Using LCI, you can check the manufacturing data for a selected module.

- 1 In the module tree, right-click the module, and then click **Details**.

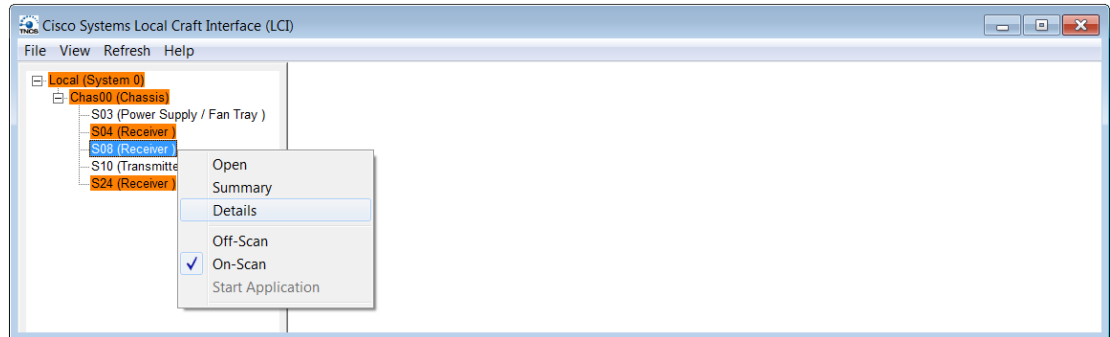

The Module Details window appears as shown in the following example. The manufacturing data is displayed under **Properties**.

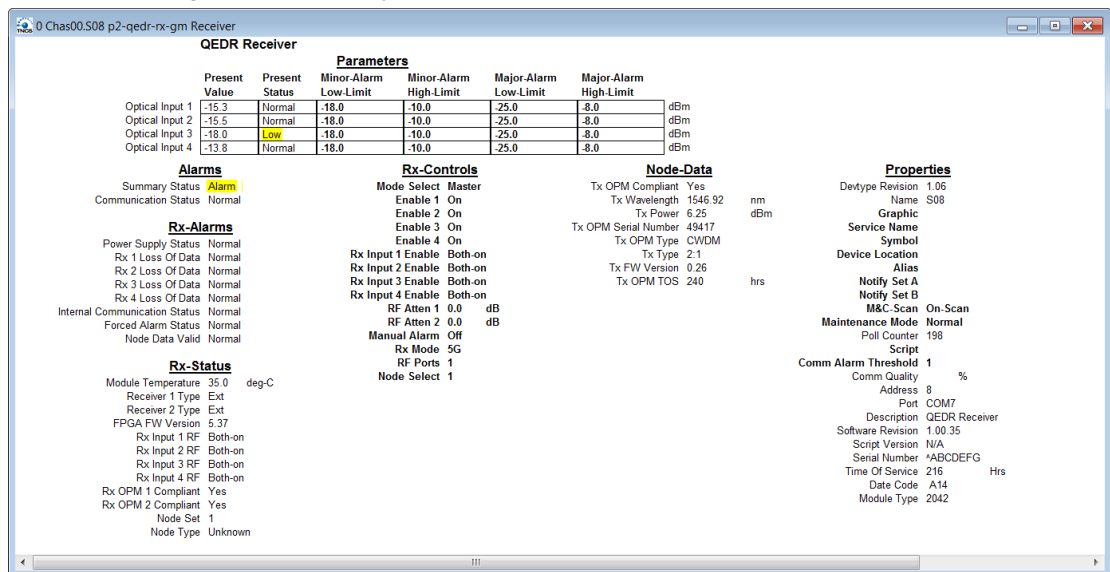

- 2 Proceed with viewing the manufacturing data.

Note: For details on all manufacturing data parameters, see *Module Parameter Descriptions* (on page 141).

5

Maintenance and Troubleshooting

Introduction

This chapter describes the maintenance guidelines and troubleshooting procedures for this Prisma II module.

Qualified Personnel

Only appropriately qualified and skilled personnel should attempt to install, operate, maintain, and service this product.



WARNING:

Allow only qualified and skilled personnel to install, operate, maintain, and service this product. Otherwise, personal injury or equipment damage may occur.

In This Chapter

■ Maintenance	132
■ General Troubleshooting Information.....	133
■ Troubleshooting Alarm Conditions.....	134

Maintenance

The following maintenance is recommended to ensure optimal performance.

Frequency	Maintenance Required
Yearly	<ul style="list-style-type: none">■ Check all parameters and test points.■ Record data.■ Make adjustments as needed.■ Make sure all cables are mated properly.■ Inspect cables for stress and chafing.■ Make sure all retaining screws are tight.■ Replace chassis air filter, if present. Depending on office environment cleanliness and filtration, the chassis air filter may require more frequent servicing.
When needed	Carefully clean the module with a soft cloth that is dampened with mild detergent.

Maintenance Record

It may be helpful to establish a maintenance record or log for this equipment. You may want to record laser power level, laser temperature readings, laser bias current, or power supply voltages, as well as the filter change dates.

Large variations in any of the parameters above should be investigated prior to failure.

General Troubleshooting Information

This troubleshooting information describes the most common alarms and gives typical symptoms, causes, and items to check before contacting Customer Service.

Equipment Needed

You may need the following equipment to troubleshoot these modules.

- Digital voltmeter
- Fiber connector cleaning materials

Additional Assistance

If you need additional assistance, telephone one of our Technical Service Centers or your local sales subsidiary. The chapter *Customer Information* (on page 139) contains a list of telephone numbers.

Troubleshooting

Refer to *Troubleshooting Alarm Conditions* (on page 134) to identify and correct faults.



WARNING:

Avoid electric shock and damage to this product! Do not open the enclosure of this product. There are no user-serviceable parts inside. Refer servicing to qualified and skilled personnel.

Troubleshooting Alarm Conditions

Module Alarm Conditions

If the red ALARM indicator is illuminated, check the display on the front panel to determine the cause of the alarm. The following tables list possible alarm conditions, causes, and solutions.

Note: Tx1Pwr - Tx4Pwr and Rx1Pwr - Rx4Pwr alarms are not applicable to GainMaker Node transmitters.

Common Alarms

Alarm	Function	Possible Causes	Possible Solutions
PsOk	Bus voltage status	<ul style="list-style-type: none"> ■ Power supply failure 	<ul style="list-style-type: none"> ■ Check power supply
Communication Status	Status of LCI communication with module (also indicated by negative poll count)	<ul style="list-style-type: none"> ■ LCI cable disconnected ■ Receiver module failure ■ PC serial port not operating correctly 	<ul style="list-style-type: none"> ■ Check LCI cable ■ Replace receiver module ■ Reconfigure PC serial port
Rx1_LOS	Loss of signal for Rx1	<ul style="list-style-type: none"> ■ Broken fiber ■ Transmitter failure ■ Faulty OPM ■ Low input power ■ Alarm limits set incorrectly 	<ul style="list-style-type: none"> ■ Check, clean fiber ■ Check transmitter ■ Replace faulty OPM
Rx2_LOS	Loss of signal for Rx2	<ul style="list-style-type: none"> ■ Broken fiber ■ Transmitter failure ■ Faulty OPM ■ Low input power ■ Alarm limits set incorrectly 	<ul style="list-style-type: none"> ■ Check, clean fiber ■ Check transmitter ■ Replace faulty OPM
Rx3_LOS	Loss of signal for Rx3	<ul style="list-style-type: none"> ■ Broken fiber ■ Transmitter failure ■ Faulty OPM ■ Low input power ■ Alarm limits set incorrectly 	<ul style="list-style-type: none"> ■ Check, clean fiber ■ Check transmitter ■ Replace faulty OPM
Rx4_LOS	Loss of signal for Rx4	<ul style="list-style-type: none"> ■ Broken fiber ■ Transmitter failure ■ Faulty OPM ■ Low input power ■ Alarm limits set incorrectly 	<ul style="list-style-type: none"> ■ Check, clean fiber ■ Check transmitter ■ Replace faulty OPM

Alarm	Function	Possible Causes	Possible Solutions
Rx1_Data	Loss of data for Rx1	<ul style="list-style-type: none"> ■ Degraded signal ■ Low input power ■ Degraded transmitter ■ Wrong mode selected 	<ul style="list-style-type: none"> ■ Check, clean fiber ■ Check transmitter output power
Rx2_Data	Loss of data for Rx2	<ul style="list-style-type: none"> ■ Degraded signal ■ Low input power ■ Degraded transmitter ■ Wrong mode selected 	<ul style="list-style-type: none"> ■ Check, clean fiber ■ Check transmitter output power
Rx3_Data	Loss of data for Rx3	<ul style="list-style-type: none"> ■ Degraded signal ■ Low input power ■ Degraded transmitter ■ Wrong mode selected 	<ul style="list-style-type: none"> ■ Check, clean fiber ■ Check transmitter output power
Rx4_Data	Loss of data for Rx4	<ul style="list-style-type: none"> ■ Degraded signal ■ Low input power ■ Degraded transmitter ■ Wrong mode selected 	<ul style="list-style-type: none"> ■ Check, clean fiber ■ Check transmitter output power
IntComm	Internal communication error	<ul style="list-style-type: none"> ■ Hardware failure 	<ul style="list-style-type: none"> ■ Replace module ■ Check for other alarms indicating fault elsewhere
Alarm	Forced alarm	<ul style="list-style-type: none"> ■ User is forcing an alarm 	<ul style="list-style-type: none"> ■ Disable "Alarm" control
Node Data	Node data valid or invalid	<ul style="list-style-type: none"> ■ Broken fiber ■ Transmitter failure 	<ul style="list-style-type: none"> ■ Check fiber ■ Check transmitter

Alarms Specific to GS7000 Nodes

Alarm	Function	Possible Causes	Possible Solutions
NdTxPwr	Tx loss of output power	<ul style="list-style-type: none"> ■ Broken cable ■ Transmitter failure 	<ul style="list-style-type: none"> ■ Check cable ■ Check transmitter
NdRxPwr	Rx loss of output power	<ul style="list-style-type: none"> ■ Low or no input power at node receiver input ■ Node receiver hardware failure 	<ul style="list-style-type: none"> ■ Replace module ■ Check for other alarms indicating fault elsewhere

Alarms Specific to Compact Nodes

Alarm	Function	Possible Causes	Possible Solutions
NdRx1LOS	Loss of input signal on Node Rx 1	<ul style="list-style-type: none"> ■ Low or no input power at node receiver input ■ Node receiver hardware failure 	<ul style="list-style-type: none"> ■ Replace module ■ Check for other alarms indicating fault elsewhere
NdRx2LOS	Loss of input signal on Node Rx 2	<ul style="list-style-type: none"> ■ Low or no input power at node receiver input ■ Node receiver hardware failure 	<ul style="list-style-type: none"> ■ Replace module ■ Check for other alarms indicating fault elsewhere
NdLidStat	Node lid is open	<ul style="list-style-type: none"> ■ Lid is open 	<ul style="list-style-type: none"> ■ Close lid

6

Customer Information

If You Have Questions

If you have technical questions, call Cisco Services for assistance. Follow the menu options to speak with a service engineer.

Access your company's extranet site to view or order additional technical publications. For accessing instructions, contact the representative who handles your account. Check your extranet site often as the information is updated frequently.

A

Module Parameter Descriptions

Introduction

This appendix provides manufacturing data, monitored parameters, configurable parameters, and alarms for the Prisma II Quad EDR Receiver module and its associated node. The examples shown in the tables are for guidance only.



CAUTION:

The warranty may be voided and the equipment damaged if you operate the equipment above the specified temperature limits (131°F/55°C for post-amplifiers, 122°F/50°C for receivers, 149°F/65°C for other products). Specification temperature limits are measured in the air stream at the fan tray inlet and may be higher than room ambient temperature.

In This Appendix

- Receiver Parameters for GS7000 Nodes..... 142
- Receiver Parameters for Compact Nodes..... 151
- Receiver Parameters for GainMaker Nodes..... 160

Receiver Parameters for GS7000 Nodes

Operating Status Parameters

Parameter Name (LCI)	ICIM Abbreviation	Function	Operating Range
Module Temperature	ModTemp	Displays module temperature	-40 °C to 100 °C
Receiver 1 Type Receiver 2 Type	RcvType1 RcvType2	Displays the receiver type, Standard (Std) or Extended Range (Ext), as determined by type of OPM installed in receiver: <ul style="list-style-type: none"> ■ Use OPM P/N 4044008 for Std ■ Use OPM P/N 4044009 for Ext 	Std or Ext
Optical Input 1 Optical Input 2 Optical Input 3 Optical Input 4	OptPin1 OptPin2 OptPin3 OptPin4	Displays optical input power in dBm for Rx1 to Rx4	-18 dBm to 0 dBm Std -25 dBm to -8 dBm Ext
FPGA FW Version	FPGA_Ver	Displays receiver FPGA version number	00.16
Rx1 Input RF Rx2 Input RF Rx3 Input RF Rx4 Input RF	Rx1_Inp Rx2_Inp Rx3_Inp Rx4_Inp	State of Rx1 Input State of Rx2 Input State of Rx3 Input State of Rx4 Input (Note that the B only setting only applies to the 5GHz Rx mode)	0 = Both off 1 = A only 2 = B only 3 = Both on
Rx OPM 1 Compliant Rx OPM 2 Compliant	Rx_OPM1 Rx_OPM2	Indicates whether the OPM installed in the receiver is compliant or not	Compliant or Non-compliant
Node Set	Node	Currently displayed node	1 to 4
Node Type	NodeType	Indicates the type of node connected to the receiver	GM/Unknown, GS7000, or Compact

Note: All parameters below this point in the table relate to the attached node and are monitor-only.			
Tx Type	TxType	Indicates the type of transmitter connected to the receiver	2:1 or 1:1
Tx OPM Type	Tx_OPM	Indicates whether the OPM installed in the transmitter is compliant or non-compliant	Compliant or Non-compl
Tx Wavelength	TxWaveIn	Displays the operating wavelength in nm of the OPM installed in the transmitter	OPM dependent
Tx OPM Serial Number	OPM_SN	Displays the serial number of the OPM installed in the transmitter	OPM dependent
Tx OPM Type	OPMType	Displays the modulation type for the OPM installed in the transmitter	DWDM or CWDM
Tx OPM TOS	OPM_TOS	OPM laser on time (hours)	OPM dependent
Tx FW Version	TxFwVer	Node transmitter firmware version	Node dependent

Control Parameters

Parameter Name (LCI)	ICIM Abbreviation	Description	Values	Default
Mode Select	Mode	Module redundancy control. If set to Master, the unit is only controlled by the Enable control. If set to Slave, the unit is controlled by the Enable control and the external input CNT_IN. If set to Single, Rx1 to Rx4 will continue to operate (i.e. not switch) even if the optical input level falls below the major alarm threshold.	0: Slave 1: Single 2: Master	Single
Enable 1 Enable 2 Enable 3 Enable 4	Enable1 Enable2 Enable3 Enable4	Enables or disables Rx1 to Rx4. If set to Off, the receiver is muted (RF amplifier turned off), alarms are inhibited, and redundancy is turned off.	0: Off 1: On	On
Rx Input 1 Enable Rx Input 2 Enable Rx Input 3 Enable Rx Input 4 Enable	Rx1Inp1 Rx1Inp2 Rx2Inp1 Rx2Inp2	This control is mainly intended for troubleshooting. It allows one to disable individual streams from appearing on the output. Note that the B only setting only applies to the 5GHz Rx mode.	0 = Both off 1 = A only 2 = B only 3 = Both on	Both On
RF Atten 1 RF Atten 2	RFAtten1 RFAtten2	Sets the RF attenuation for output A or output B. Note: In one RF output operation mode, RF Atten 1 controls the combined RF signal for input 1 and input 3 , RF Atten 2 controls the combined RF signal for input 2 and input 4.	0 to 10 dB in 0.5 dB steps	0 dB
Manual Alarm ^{1,2}	Alarm ¹	Force alarm if the Enable control is On.	0: Off 1: On	Off

Appendix A
Module Parameter Descriptions

Parameter Name (LCI)	ICIM Abbreviation	Description	Values	Default
Rx Mode ¹	RxMode ¹	Sets the receiver operating mode 2.5GHz or 5GHz. Note: Changing the Rx Mode forces the FPGA to be reprogrammed. This takes about 10 seconds, so user may notice a delay before the change takes effect.	0: 5GHz 1: 2.5GHz	5GHz
RF Ports	RxPorts	Sets whether the RF output is gated to both connectors or just the top connector. Refer to block diagrams on page 28.	1 2	1
Node Select	NodeSel	Selects the node to be monitored (Node 1 to Node 4)	1: Node 1 2: Node 2 3: Node 3 4: Node 4	1
Note: All parameters below this point in the table relate to the attached node and are monitor-only.				
Path 1 Redundancy Path 2 Redundancy	NdPth1Rd NdPth2Rd	Selects the redundancy mode for the node connected to the Rx1 or Rx2 optical path: Primary, Redundant, or Failure.	0: N/A 1: Primary 2: Redundant 3: Failure	
Node Temperature	NodeTemp	Node temperature in degrees C	degC	
PS 1 Status PS 2 Status	NdPS1Flt NdPS2Flt	Indication that one or more PS1 or PS2 voltages are out of spec.	0: OK 1: Fault	
AC Status	NdACFlt	Indicates that the AC power input is either too high or too low.	0: OK 1: Fault	
PS 1 24V PS 2 24V	NdPS1+24 NdPS2+24	Indicates the actual output voltage of the PS1 or PS2 +24 VDC power supply.	V	N/A
Tx 1 Power Level Tx 2 Power Level Tx 3 Power Level Tx 4 Power Level	NdTx1Pwr NdTx2Pwr NdTx3Pwr NdTx4Pwr	Indicates the output power of Tx1, Tx2, Tx3, or Tx4.	dBm	

Parameter Name (LCI)	ICIM Abbreviation	Description	Values	Default
Rx 1 Power Level	NdRx1Pwr	Indicates the output power of Rx1, Rx2, Rx3, or Rx4.	dBm	
Rx 2 Power Level	NdRx2Pwr			
Rx 3 Power Level	NdRx3Pwr			
Rx 4 Power Level	NdRx4Pwr			

¹ Parameter value can be modified by the user using the ICIM2 or ICIM2-XD, LCI software, ROSA software, CLI commands, or the ICIM Web Interface.

² Manual Alarm appears in the LCI menu only when the receiver is in Master redundancy mode.

Appendix A
Module Parameter Descriptions

Alarm Parameters

Parameter Name (LCI)	ICIM Abbreviation	Description	Major Low	Minor Low	Minor High	Major High	Operating Range
Power Supply Status	PsOk	Alarm if +24 or -5V fails	-	-	-	-	OK or Alarm
-	Rx1_LOS ¹ Rx2_LOS ¹ Rx3_LOS ¹ Rx4_LOS ¹	Loss of Node optical signal for Rx1 to Rx4	-18.0 dB Std	-15.0 dB	-10.0 dB	-8.0 dB	OK or Alarm
Rx 1 Loss of Data ¹ Rx 2 Loss of Data ¹ Rx 3 Loss of Data ¹ Rx 4 Loss of Data ¹	Rx1_Data Rx2_Data Rx3_Data Rx4_Data	Loss of data for Rx1 to Rx4	-	-	-	-	OK or Alarm
Internal Communication Status	IntComm	Internal communication error	-	-	-	-	OK or Alarm
Forced Alarm Status	Alarm	Manual alarm state	-	-	-	-	OK or Alarm
Node Data Valid	NodeData	Node data valid or invalid	-	-	-	-	OK or Alarm
Note: All parameters below this point in the table relate to the attached node and are monitor-only.							
Tx Power Status	NdTxPwr	Output power alarm for transmitter	-	-	-	-	OK or Alarm
Rx Power Status	NdRxPwr	Output power alarm for receiver	-	-	-	-	OK or Alarm
EDR Optical Level			1 dBm	2 dBm	8 dBm	9dBm	
			1.3 mW	1.6 mW	6.3 mW	7.9 mW	

¹ Alarm threshold values can be modified by the user using the ICIM2 or ICIM2-XD, LCI software, ROSA software, CLI commands, or the ICIM Web Interface.

² Note the logical sequence of the alarm parameters. Major Low<Minor Low<Minor High<Major High. Operating error can be caused when an illogical parameter is input as the alarm.

Manufacturing Data Parameters

Parameter Name (LCI)	ICIM Abbreviation	Typical Values
Name	-	S16
-	Module name	P2-HD-QEDR-RX
Module Type	Type number	2040 (GS7000 PNP) 2041 (Compact PNP) 2042 (GainMaker)
Description	-	Quad EDR Receiver
Software Revision	-	1.00.46
Script Version	-	N/A
Serial Number	mfg serial # string	^ABCDEFGF
Time of Service	-	2 Hrs
-	Mfg data string	(not used)
Date Code	Mfg date code	A11
-	Mfg module ID	MDID (not used)
Serial Number	Mfg serial # string	^ABCDEFGF
-	CLEI	(not used)
-	CLLI	(not used)

Receiver Parameters for Compact Nodes

Operating Status Parameters

Appendix A
Module Parameter Descriptions

Parameter Name (LCI)	ICIM Abbreviation	Function	Operating Range
Module Temperature	ModTemp	Displays module temperature	-40 °C to 100 °C
Receiver 1 Type Receiver 2 Type	RcvType1 RcvType2	Displays the receiver type, Standard (Std) or Extended Range (Ext), as determined by type of OPM installed in receiver: <ul style="list-style-type: none"> ■ Use OPM P/N 4044008 for Std ■ Use OPM P/N 4044009 for Ext 	Std or Ext
Optical Input 1 Optical Input 2 Optical Input 3 Optical Input 4	OptPin1 OptPin2 OptPin3 OptPin4	Displays optical input power in dBm for Rx1 to Rx4	-18 dBm to 0 dBm Std -25 dBm to -8 dBm Ext
FPGA FW Version	FPGA_Ver	Displays receiver FPGA version number	00.16
Rx1 Input RF Rx2 Input RF Rx3 Input RF Rx4 Input RF	Rx1_Inp Rx2_Inp Rx3_Inp Rx4_Inp	State of Rx1 Input State of Rx2 Input State of Rx3 Input State of Rx4 Input (Note that the B only setting only applies to the 5GHz Rx mode)	0 = Both off 1 = A only 2 = B only 3 = Both on
Rx OPM 1 Compliant Rx OPM 2 Compliant	Rx_OPM1 Rx_OPM2	Indicates whether the OPM installed in the receiver is compliant or not	Compliant or Non-compliant
Node Set	Node	Currently displayed node	1 to 4
Node Type	NodeType	Indicates the type of node connected to the receiver	GM/Unknown, GS7000, or Compact
Note: All parameters below this point in the table relate to the attached node and are monitor-only.			
Node Firmware Version	NdFwVer	Displays node microcontroller firmware version	Node dependent

Parameter Name (LCI)	ICIM Abbreviation	Function	Operating Range
Tx Firmware Version	TxFwVer	Displays the EDR transmitter firmware version	Node Dependent
Tx OPM TOS	OPM_TOS	OPM laser on time in hours	Node dependent
Tx OPM Type	OPM_Type	Displays the modulation type for the OPM installed in the transmitter	DWDM or CWDM
Tx Wavelength	TxWaveIn	Displays the operating wavelength of the OPM installed in the transmitter	OPM dependent
Tx OPM Serial Number	OPM_SN	Displays the serial number of the OPM installed in the transmitter	OPM dependent
Tx OPM Compliant	Tx_OPM	Indicates whether the OPM installed in the transmitter is compliant or non-compliant	Compliant or Non-compl
Tx Output Power	NdOpmPwr	Displays the Node 1 optical output power	dBm
Rx 1 Input Power Rx 2 Input Power	NdRx1Pwr NdRx2Pwr	Displays the node Rx1 or Rx2 RF input power	dBm

Control Parameters

Parameter Name (LCI)	ICIM Abbreviation	Description	Values	Default
Mode Select	Mode	Module redundancy control. If set to Master, the unit is only controlled by the Enable control. If set to Slave, the unit is controlled by the Enable control and the external input CNT_IN. If set to Single, Rx1 to Rx4 will continue to operate (i.e. not switch) even if the optical input level falls below the major alarm threshold.	0: Slave 1: Single 2: Master	Single
Enable 1 Enable 2 Enable 3 Enable 4	Enable1 Enable2 Enable3 Enable4	Enables or disables Rx1 to Rx4. If set to Off, the receiver is muted (RF amplifier turned off), alarms are inhibited, and redundancy is turned off.	0: Off 1: On	On
Rx Input 1 Enable Rx Input 2 Enable Rx Input 3 Enable Rx Input 4 Enable	Rx1Inp1 Rx1Inp2 Rx2Inp1 Rx2Inp2	This control is mainly intended for troubleshooting. It allows one to disable individual streams from appearing on the output. Note that the B only setting only applies to the 5GHz Rx mode.	0 = Both off 1 = A only 2 = B only 3 = Both on	Both On
RF Atten 1 RF Atten 2	RFAtten1 RFAtten2	Sets the RF attenuation for output A or output B. Note: In one RF output operation mode, RF Atten 1 controls the combined RF signal for input 1 and input 3 , RF Atten 2 controls the combined RF signal for input 2 and input 4.	0 to 10 dB in 0.5 dB steps	0 dB
Manual Alarm ^{1,2}	Alarm ¹	Force alarm if the Enable control is On.	0: Off 1: On	Off

Appendix A
Module Parameter Descriptions

Parameter Name (LCI)	ICIM Abbreviation	Description	Values	Default
Rx Mode ¹	RxMode ¹	Sets the receiver operating mode 2.5GHz or 5GHz. Note: Changing the Rx Mode forces the FPGA to be reprogrammed. This takes about 10 seconds, so user may notice a delay before the change takes effect.	0: 5GHz 1: 2.5GHz	5GHz
RF Ports	RxPorts	Sets whether the RF output is gated to both connectors or just the top connector. Refer to block diagrams in page 28.	1 2	1
Node Select	NodeSel	Selects the node to be monitored (Node 1 to Node 4)	1: Node 1 2: Node 2 3: Node 3 4: Node 4	1
Note: All parameters below this point in the table relate to the attached node and are monitor-only.				
Node Temperature	NodeTemp	Indicates the temperature of the node interior	degC	N/A
PS 24V	Node+24V	Indicates the actual voltage on the +24V rail of the node power supply bus.	V	N/A
PS 7V	Node+7V	Indicates the actual voltage on the +7V rail of the node power supply bus.	V	N/A
PS AC	NodeAC	Indicates the AC voltage at the node AC power input.	V	N/A
Forward Mode	NdFwdMod	Sets the forward mode for the node. In Redundant mode, the node automatically selects between one of two forward receivers, FRx1 or FRx2. In Segmented or Single mode, only one receiver (determined during node setup) will be active and selected.	0: Segmented 1: Redundant 2: Single	N/A

Parameter Name (LCI)	ICIM Abbreviation	Description	Values	Default
Forward Receiver	NdFwdRx	Displays the currently active forward receiver, FRx1, FRx2, or None.	0: PreferRx1 1: PreferRx2 2: ForceRx1 3: ForceRx2	N/A
Return Path Attenuation 1 Return Path Attenuation 2	NdRP1Att NdRP2Att	Return path 1 or 2 attenuation setting	0: 0 dB (min atten) 6: 6 dB 70: max atten	N/A

¹ Parameter value can be modified by the user using the ICIM2 or ICIM2-XD, LCI software, ROSA software, CLI commands, or the ICIM Web Interface.

Alarm Parameters

Parameter Name (LCI)	ICIM Abbreviation	Description	Major Low	Minor Low	Minor High	Major High	Operating Range
Power Supply Status	PsOk	Alarm if +24 or -5V fails	-	-	-	-	OK or Alarm
-	Rx1_LOS ¹ Rx2_LOS ¹ Rx3_LOS ¹ Rx4_LOS ¹	Loss of Node optical signal for Rx1 to Rx4	-18.0 dB Std	-15.0 dB	-10.0 dB	-8.0 dB	OK or Alarm
Rx 1 Loss of Data ¹ Rx 2 Loss of Data ¹ Rx 3 Loss of Data ¹ Rx 4 Loss of Data ¹	Rx1_Data Rx2_Data Rx3_Data Rx4_Data	Loss of data for Rx1 to Rx4	-	-	-	-	OK or Alarm
Internal Communication Status	IntComm	Internal communication error	-	-	-	-	OK or Alarm
Forced Alarm Status	Alarm	Manual alarm state	-	-	-	-	OK or Alarm
Node Data Valid	NodeData	Node data valid or invalid	-	-	-	-	OK or Alarm
Note: All parameters below this point in the table relate to the attached node and are monitor-only.							
-	NdRx1LOS NdRx2LOS	Loss of signal in Rx1 or Rx2	-	-	-	-	OK or Alarm
-	NdLidStat ¹	Status of node lid (open/closed)	-	-	-	-	OK or Alarm

¹ Alarm threshold values can be modified by the user using the ICIM2 or ICIM2-XD, LCI software, ROSA software, CLI commands, or the ICIM Web Interface.

Manufacturing Data Parameters

Parameter Name (LCI)	ICIM Abbreviation	Typical Values
Name	-	S16
-	Module name	P2-HD-QEDR-RX
Module Type	Type number	2040 (GS7000 PNP) 2041 (Compact PNP) 2042 (GainMaker)
Description	-	Quad EDR Receiver
Software Revision	-	1.00.46
Script Version	-	N/A
Serial Number	mfg serial # string	^ABCDEFGF
Time of Service	-	2 Hrs
-	Mfg data string	(not used)
Date Code	Mfg date code	A11
-	Mfg module ID	MDID (not used)
Serial Number	Mfg serial # string	^ABCDEFGF
-	CLEI	(not used)
-	CLLI	(not used)

Receiver Parameters for GainMaker Nodes

Operating Status Parameters

Parameter Name (LCI)	ICIM Abbreviation	Function	Operating Range
Module Temperature	ModTemp	Displays module temperature	-40 °C to 100 °C
Receiver 1 Type Receiver 2 Type	RcvType1 RcvType2	Displays the receiver type, Standard (Std) or Extended Range (Ext), as determined by type of OPM installed in receiver: <ul style="list-style-type: none"> ■ Use OPM P/N 4044008 for Std ■ Use OPM P/N 4044009 for Ext 	Std or Ext
Optical Input 1 Optical Input 2 Optical Input 3 Optical Input 4	OptPin1 OptPin2 OptPin3 OptPin4	Displays optical input power in dBm for Rx1 to Rx4	-18 dBm to 0 dBm Std -25 dBm to -8 dBm Ext
FPGA FW Version	FPGA_Ver	Displays receiver FPGA version number	00.16
Rx1 Input RF Rx2 Input RF Rx3 Input RF Rx4 Input RF	Rx1_Inp Rx2_Inp Rx3_Inp Rx4_Inp	State of Rx1 Input State of Rx2 Input State of Rx3 Input State of Rx4 Input (Note that the B only setting only applies to the 5GHz Rx mode)	0 = Both off 1 = A only 2 = B only 3 = Both on
Rx OPM 1 Compliant Rx OPM 2 Compliant	Rx_OPM1 Rx_OPM2	Indicates whether the OPM installed in the receiver is compliant or not	Compliant or Non-compliant
Node Set	Node	Currently displayed node	1 to 4
Node Type	NodeType	Indicates the type of node connected to the receiver	GM/Unknown, GS7000, or Compact

Note: All parameters below this point in the table relate to the attached node and are monitor-only.			
Tx Type	TxType	Indicates the type of transmitter connected to the receiver	2:1 or 1:1
Tx OPM Type	Tx_OPm	Indicates whether the OPM installed in the transmitter is compliant or non-compliant	Compliant or Non-compl
Tx Wavelength	TxWaveIn	Displays the operating wavelength in nm of the OPM installed in the transmitter	OPM dependent
Tx Power	TxPower	Displays the output power in dBm of the OPM installed in the transmitter	OPM dependent
Tx OPM Serial Number	OPM_SN	Displays the serial number of the OPM installed in the transmitter	OPM dependent
Tx OPM Type	OPMType	Displays the modulation type for the OPM installed in the transmitter	DWDM or CWDM
Tx OPM TOS	OPM_TOS	OPM laser on time (hours)	OPM dependent
Tx FW Version	TxFwVer	Node transmitter firmware version	Node dependent

Control Parameters

Parameter Name (LCI)	ICIM Abbreviation	Description	Values	Default
Mode Select	Mode	Module redundancy control. If set to Master, the unit is only controlled by the Enable control. If set to Slave, the unit is controlled by the Enable control and the external input CNT_IN. If set to Single, Rx1 to Rx4 will continue to operate (i.e. not switch) even if the optical input level falls below the major alarm threshold.	0: Slave 1: Single 2: Master	Single
Enable 1 Enable 2 Enable 3 Enable 4	Enable1 Enable2 Enable3 Enable4	Enables or disables Rx1 to Rx4. If set to Off, the receiver is muted (RF amplifier turned off), alarms are inhibited, and redundancy is turned off.	0: Off 1: On	On
Rx Input 1 Enable Rx Input 2 Enable Rx Input 3 Enable Rx Input 4 Enable	Rx1Inp1 Rx1Inp2 Rx2Inp1 Rx2Inp2	This control is mainly intended for troubleshooting. It allows one to disable individual streams from appearing on the output. Note that the B only setting only applies to the 5GHz Rx mode.	0 = Both off 1 = A only 2 = B only 3 = Both on	Both On
RF Atten 1 RF Atten 2	RFAtten1 RFAtten2	Sets the RF attenuation for output A or output B. Note: In one RF output operation mode, RF Atten 1 controls the combined RF signal for input 1 and input 3 , RF Atten 2 controls the combined RF signal for input 2 and input 4.	0 to 10 dB in 0.5 dB steps	0 dB
Manual Alarm ^{1,2}	Alarm ¹	Force alarm if the Enable control is On.	0: Off 1: On	Off

Appendix A
Module Parameter Descriptions

Parameter Name (LCI)	ICIM Abbreviation	Description	Values	Default
Rx Mode ¹	RxMode ¹	Sets the receiver operating mode 2.5GHz or 5GHz. Note: Changing the Rx Mode forces the FPGA to be reprogrammed. This takes about 10 seconds, so user may notice a delay before the change takes effect.	0: 5GHz 1: 2.5GHz	5GHz
RF Ports	RxPorts	Sets whether the RF output is gated to both connectors or just the top connector. Refer to block diagrams in page 28.	1 2	1
Node Select	NodeSel	Selects the node to be monitored (Node 1 to Node 4)	1: Node 1 2: Node 2 3: Node 3 4: Node 4	1

¹ Parameter value can be modified by the user using the ICIM2 or ICIM2-XD, LCI software, ROSA software, CLI commands, or the ICIM Web Interface.

Alarm Parameters

Parameter Name (LCI)	ICIM Abbreviation	Description	Major Low	Minor Low	Minor High	Major High	Operating Range
Power Supply Status	PsOk	Alarm if +24 or -5V fails	-	-	-	-	OK or Alarm
-	Rx1_LOS ¹ Rx2_LOS ¹ Rx3_LOS ¹ Rx4_LOS ¹	Loss of Node optical signal for Rx1 to Rx4	-18.0 dB Std	-15.0 dB	-10.0 dB	-8.0 dB	OK or Alarm
Rx 1 Loss of Data ¹ Rx 2 Loss of Data ¹ Rx 3 Loss of Data ¹ Rx 4 Loss of Data ¹	Rx1_Data Rx2_Data Rx3_Data Rx4_Data	Loss of data for Rx1 to Rx4	-	-	-	-	OK or Alarm
Internal Communication Status	IntComm	Internal communication error	-	-	-	-	OK or Alarm
Forced Alarm Status	Alarm	Manual alarm state	-	-	-	-	OK or Alarm
Node Data Valid	NodeData	Node data valid or invalid	-	-	-	-	OK or Alarm

¹ Alarm threshold values can be modified by the user using the ICIM2 or ICIM2-XD, LCI software, ROSA software, CLI commands, or the ICIM Web Interface.

Manufacturing Data Parameters

Parameter Name (LCI)	ICIM Abbreviation	Typical Values
Name	-	S16
-	Module name	P2-HD-QEDR-RX
Module Type	Type number	2040 (GS7000 PNP) 2041 (Compact PNP) 2042 (GainMaker)
Description	-	Quad EDR Receiver
Software Revision	-	1.00.46
Script Version	-	N/A
Serial Number	mfg serial # string	^ABCDEFGF
Time of Service	-	2 Hrs
-	Mfg data string	(not used)
Date Code	Mfg date code	A11
-	Mfg module ID	MDID (not used)
Serial Number	Mfg serial # string	^ABCDEFGF
-	CLEI	(not used)
-	CLLI	(not used)

Glossary

ac, AC

alternating current. An electric current that reverses its direction at regularly recurring intervals.

AGC

automatic gain control. A process or means by which gain is automatically adjusted in a specified manner as a function of input level or other specified parameters.

bdr

baseband digital reverse. Proprietary technology for transporting reverse signals by converting them to from analog to digital format, optionally multiplexing two or more digitized reverse signals, and then converting the electrical signal to an optical format for transmission to a hub or headend via fiber optic link.

CAN

cancel. The cancel character.

DAC

Digital to Analog Converter.

DAVIC

Digital Audio Visual Council.

dc, DC

direct current. An electric current flowing in one direction only and substantially constant in value.

DFB laser

distributed feedback laser. An injection laser diode that has a Bragg reflection grating in the active region in order to suppress multiple longitudinal modes and enhance a single longitudinal mode.

Glossary

DOCSIS

Data Over Cable service Interface Specification.

DRR

dual reverse receiver.

EDFA

erbium doped fiber amplifier. Optical fibers doped with the rare earth element, erbium, which can amplify light in the 1550 nm region when pumped by an external light source.

EDR

enhanced digital return. See bdr.

EIA

Electronic Industries Association. A United States association that provides standards for use between manufacturers and purchasers of electronic products.

EMC

electromagnetic compatibility. A measure of equipment tolerance to external electromagnetic fields.

EMT

externally-modulated transmitter.

ESD

electrostatic discharge. Discharge of stored static electricity that can damage electronic equipment and impair electrical circuitry, resulting in complete or intermittent failures.

HD

high density.

I/O

input/output.

ICIM

intelligent communications interface module.

IP

Internet protocol. A standard that was originally developed by the United States Department of Defense to support the internetworking of dissimilar computers across a network. IP is perhaps the most important of the protocols on which the Internet is based. It is the standard that describes software that keeps track of the internetwork addresses for different nodes, routes, and outgoing/incoming messages on a network. Some examples of IP applications include email, chat, and Web browsers.

LCD

liquid crystal display. A display medium made of liquid crystal. Liquid crystal's reflectance changes when an electric field is applied. Commonly used in monitors, televisions, cell phones, digital watches, etc.

LCI

local craft interface.

LED

light-emitting diode. An electronic device that lights up when electricity passes through it.

MIB

management information base. SNMP collects management information from devices on the network and records the information in a management information base. The MIB information includes device features, data throughput statistics, traffic overloads, and errors.

nm

nanometer. One billionth of a meter.

NMS

network management system. A software system designed specifically to monitor a network and to facilitate troubleshooting.

Glossary

OMI

optical modulation index, expressed in decimal or percentage notation.

OPM

optical pluggable module.

PLL

phase lock loop. An electronic servo system controlling an oscillator to maintain a constant phase angle relative to a reference signal.

QAM

quadrature amplitude modulation. An amplitude and phase modulation technique for representing digital information and transmitting that data with minimal bandwidth. Both phase and amplitude of carrier waves are altered to represent the binary code. By manipulating two factors, more discrete digital states are possible and therefore larger binary schemes can be represented.

RF

radio frequency. The frequency in the portion of the electromagnetic spectrum that is above the audio frequencies and below the infrared frequencies, used in radio transmission systems.

RMA

return material authorization. A form used to return products.

RT

remote terminal. Remote equipment of a supervisory system.

RX

receive or receiver.

SBS

stimulated Brillouin scattering. The easiest fiber nonlinearity to trigger. When a powerful lightwave travels through a fiber, it interacts with acoustical vibration modes in the glass. This causes a scattering mechanism to be formed that reflects some of the light back to the source.

SMC

status monitoring and control. The process by which the operation, configuration, and performance of individual elements in a network or system are monitored and controlled from a central location.

SNMP

simple network management protocol. A protocol that governs network management and the monitoring of network devices and their functions.

TEC

thermoelectric cooler. A device used to dissipate heat in electronic assemblies.

torque

A force that produces rotation or torsion. Usually expressed in lb-ft (pound-feet) or N-m (Newton-meters). The application of one pound of force on a lever at a point on the lever that is one foot from the pivot point would produce 1 lb-ft of torque.

TX

transmit or transmitter.

Index

A

- ac, AC • 155
- Access Requirements • 45
- Accessing the Module Detail Information • 117
- Additional Assistance • 129
- Adjusting Alarm Thresholds • 104
- AGC • 155
- Alarm Parameters • 141, 148, 153
- Alarm Threshold Menus • 89
- ALARMS IN and ALARMS OUT Connector Illustration • 65
- ALARMS IN and ALARMS OUT Connectors • 64
- ALARMS Menus • 92

B

- Back Panel Connectors • 37
- Basic SNMP Setup • 96
- bdr • 155

C

- Cable Requirements • 107
- Cable Routing - Prisma II Chassis • 57
- Cable Routing - Prisma XD Chassis • 58
- CAN • 155

- Checking Alarms using the ICIM • 91
- Checking Manufacturing Data using LCI • 126
- Checking Manufacturing Data using the ICIM • 93
- Checking the Module Alarms using LCI • 123
- Checking the Operating Status • 120
- Checking the Operating Status using the ICIM • 86
- Cleaning Optical Connectors • 55
- Community Strings • 100
- Computer Requirements • 107
- CONFIG Menus • 90
- Configuration and Monitoring Methods • 40
- Configuration Complete • 95
- Configuration Summary • 41
- Configuring Redundancy • 63
- Configuring the Module using LCI • 121
- Configuring the Module using the ICIM • 88
- Connecting Optical Cables • 57
- Connecting the ICIM to Additional Chassis • 61
- Connecting the RF Cables to the Chassis • 49
- Connecting Your Computer to the Chassis • 112, 114
- Control Parameters • 139, 145, 151

Customer Information • 44, 96, 129, 135

D

dc, DC • 155

Default Community Strings • 100

DFB laser • 155

DRR • 155

E

EDFA • 155

EDR • 156

EDR Receiver Front and Back Panel • 36

EDR Receiver Software Menu Structure • 83

EIA • 156

EMC • 156

EMT • 156

Equipment and Tools Needed • 44

Equipment Needed • 129

Equipment Rack • 45

ESD • 156

Expired Password or Inactive Password
Messages • 76, 77

External Alarm Connections • 63

F

Fiber Fish Tool • 57

Fiber Fish Tool Hook • 57

Front-Access Chassis - Front Panel Illustration •
47

G

General Troubleshooting Information • 129

H

HD • 156

Host Module • 38

Host Module Back Panel Connectors • 39

Host Module Features • 38

Host Module Illustration • 38

I

I/O • 156

ICIM • 156

ICIM Block Diagram • 72

ICIM Function • 71

ICIM IN and ICIM OUT Cables • 61

ICIM IN and ICIM OUT Connectors • 61

ICIM Introduction • 71

ICIM Keypad • 75

ICIM LCD • 74

ICIM MAIN Menu • 81

ICIM MAIN Menu Illustration • 74, 82

ICIM Password • 76

ICIM2 Front Panel • 73

ICIM2 Front Panel Features • 74

ICIM2 Illustration (Front Panel) • 73

Installing LCI • 108

Installing the Module in the Chassis • 51

IP • 156

L

Laser Warning • 34, 71

LCD • 156

LCI • 157

LCI Function • 106

LCI Introduction • 106

LCI Module Tree • 116

LED • 157

M

Maintenance • 128

Maintenance and Troubleshooting • 127

Maintenance Record • 128

Manufacturing Data Parameters • 143, 149, 154

Master/Slave Illustration • 65

MFG. DATA Menus • 94

MIB • 157

Modifying Module Alarm Limits using LCI •
124

Module Alarm Conditions • 130

Module Configuration • 40

Module Details Window • 118

Module Installation • 43

Module Introduction • xxii

Module Tree • 116

N

New SNMP Variables • 102

nm • 157

NMS • 157

O

OMI • 157

Operating Environment • 45

Operating Status Parameters • 138, 144, 150

Operating the ICIM • 81

Operation using ICIM • 40, 41, 63, 69

Operation using LCI • 40, 41, 63, 105

P

Password Protection System • 76

PLL • 157

Power Requirements • 45

Preparing for Installation • 44

Previous IP Address • 103

Prisma II ICIM Menu • 82

Prisma II MAIN Menu and ICIM Menu
Structure • 83

Prisma II Redundancy Interface Panel
Illustrations • 67

Prisma II Standard Chassis Style • 46

Prisma II XD Chassis Style • 48

Q

QAM • 157

R

Rear-Access Chassis - Front Panel Illustration •
47

Receiver Block Diagram • 35

Receiver Description • 24

Index

- Receiver Features • 24
- Receiver Front Panel Features • 36
- Receiver Illustration (Front and Back) • 36
- Receiver Operating Modes • 26
- Receiver Operation • 24
- Receiver Optical Input • 34
- Receiver Overview • 24
- Receiver Parameters for Compact Nodes • 144
- Receiver Parameters for GainMaker Nodes • 150
- Receiver Parameters for GS7000 Nodes • 138
- Recommended Equipment • 55
- Redundancy Interface Panel • 66
- RF • 157
- RMA • 158
- RT • 158
- RX • 158
- S**
- Saving the Configuration using the ICIM • 95
- SBS • 158
- Setting SNMP Trap Receiver Parameters • 101
- Site Requirements • 45
- SMC • 158
- SNMP • 158
- SNMP Configuration • 96
- SNMP Considerations • 96
- Space Requirements • 46
- Starting LCI Software • 114
- STATUS Menus • 87
- System Requirements • 107
- T**
- Table of Inserted Modules • 102
- Table of Removed Modules • 102
- TEC • 158
- Tips for Optimal Fiber Optic Connector Performance • 55
- To Access the ICIM LCD Contrast • 81
- To Access the Module Details, Right-Click the Module • 119
- To Access the Password Menu • 77, 78
- To Adjust Alarm Thresholds • 104
- To Change the User Password • 78
- To Check Alarms using ICIM • 91
- To Check Alarms using LCI • 123
- To Check Manufacturing Data • 93
- To Check Manufacturing Data using LCI • 126
- To Check Operating Status using LCI • 120
- To Check the Operating Status using ICIM • 86
- To Clean Optical Connectors • 56
- To Configure Parameters using LCI • 121
- To Configure Parameters using the ICIM • 88
- To Connect a Computer to the Chassis • 112
- To Connect Chassis-to-Chassis ICIM IN and ICIM OUT Ports • 62
- To Connect Optical Cables to Module • 59
- To Connect RF Cables for Each Module • 49

- To Disable the User Password using ICIM • 79
 - To Enter the User Password • 76, 77
 - To Install the LCI Software • 108
 - To Install the Module in a Prisma II XD Chassis
 - 53
 - To Install the Module in the Chassis • 52
 - To Install the Receiver Modules in the Host Module • 51
 - To Modify Alarm Limits using LCI • 124
 - To Pull the Optical Cable to the Module • 58
 - To Restart the ICIM by Removing the ICIM • 99
 - To Save the Current Configuration • 95
 - To Set Adjustable Alarm Thresholds using the ICIM • 92
 - To Set Traps for a Specific IP Address using P2TrapRecvEntry • 101
 - To Set Up the IP Configuration Parameters for SNMP Support using ICIM • 98
 - To Start LCI Software • 114
 - torque • 158
 - Troubleshooting • 129
 - Troubleshooting Alarm Conditions • 120, 129, 130
 - TX • 158
- U**
- Unpacking and Inspecting the Module • 44
 - Using the ICIM • 81



Americas Headquarters

Cisco Systems, Inc.
170 West Tasman Drive
San Jose, CA 95134-1706
USA

<http://www.cisco.com>
Tel: 408 526-4000
800 553-6387
Fax: 408 527-0883

This document includes various trademarks of Cisco Systems, Inc. Please see the Notices section of this document for a list of Cisco Systems, Inc., trademarks used in this document. Product and service availability are subject to change without notice.

© 2017 Cisco Systems, Inc. All rights reserved.

First Published: January 2016
Last Modified: May 2017